

# SKILL<sup>®</sup>

Surgical Instruments

## CARDIOVASCULAR & THORACIC INSTRUMENTS

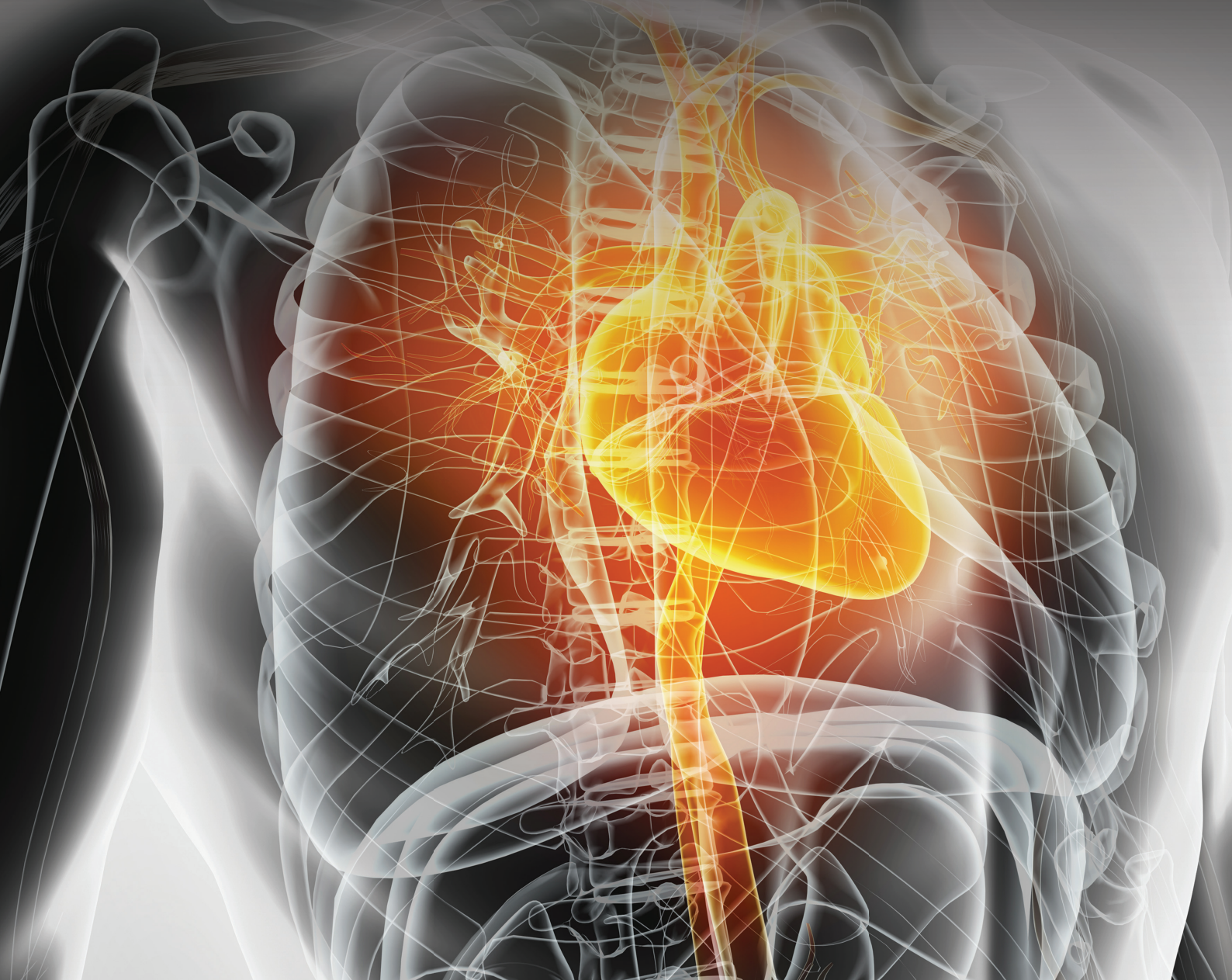



## **SKILL® The World's Best Surgical Instruments**

All **SKILL®** Instruments are manufactured on a three-pillar principle, namely raw material quality, skilled craftsmanship as well as precise and validated heat treatment and tempering.

Our goal is achieved by using German Forgings and German Steel for the production of our **SKILL®** Instruments. Using only German Craftsmanship, engineering and know-how throughout the manufacturing process along with the validated heat treatment is a necessity in the production of our **SKILL®** Instruments.

**SKILL®** Instruments are manufactured in Germany according to the EU Directive 93/42/EWG, as well as the following ISO Standards;

ISO: 9001  
ISO:13458  
ISO: 7153-1

No compromise is made on the quality of a **SKILL®** Surgical Instrument. The **SKILL®** short chain of supply allows clients to purchase the highest quality of Instrument at the most competitive pricing.

**SKILL®** Instruments offer the Surgeon a heightened sense of Instrument control allowing the Surgeon to greatly reduce the trauma and risk associated with Surgery.

### ***OPERATE WITH SKILL®, OPERATE WITH US.***

**SKILL®** Instruments carry a Lifetime warranty which covers any material defect or faulty manufacturing.

**SKILL®** Instruments will be repaired or replaced free of charge without compromise to the product in the event of a valid claim.

**SKILL®** Instruments are to be returned to the authorised distributor for maintenance, any work carried out by an unauthorised person will void the warranty.

No part of the Catalogue may be copied, forwarded or distributed without the express written consent given by the Manufacturer or its Distributor.

*Operate with* **SKILL®**  
Surgical Instruments

# INDEX

<b>MICRO SCISSORS</b>	<b>5</b>
<b>MICRO FORCEPS</b>	<b>113</b>
<b>MICRO NEEDLE HOLDERS</b>	<b>133</b>
<b>MICRO VASCULAR CLAMPS</b>	<b>171</b>
<b>CARDIOVASCULAR RETRACTORS</b>	<b>261</b>
<b>MICS &amp; VATS CARDIAC INSTRUMENTS</b>	<b>363</b>
<b>SPECIALITY INSTRUMENTS</b>	<b>453</b>



**BLACK COATED SURGICAL INSTRUMENTS**



**TUNGSTEN CARBIDE INSERTS**



**TITANIUM SURGICAL INSTRUMENTS**



**DIAMOND DUST/TC DUST INSERTS**

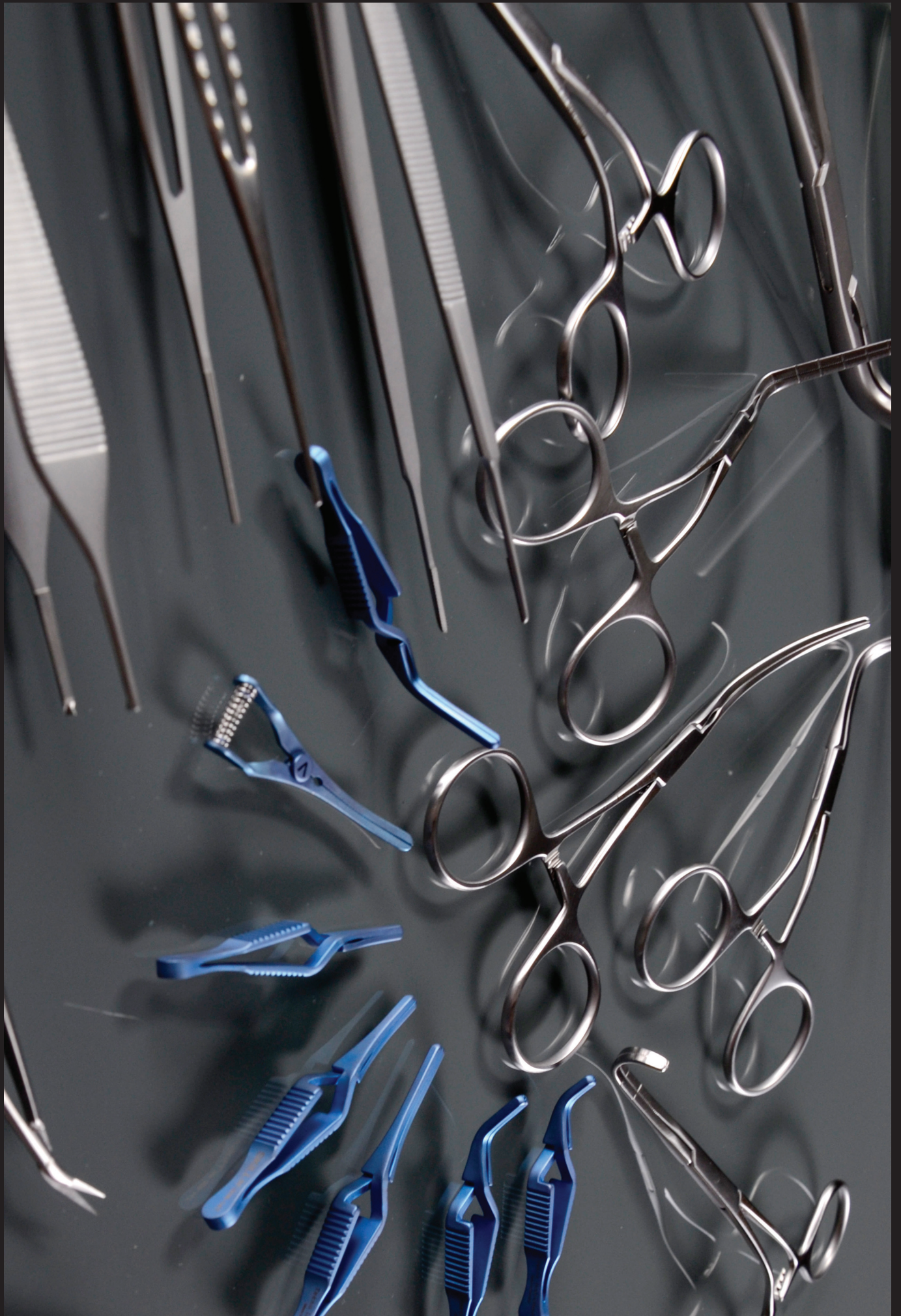

# SKILL<sup>®</sup>

Surgical Instruments

## SCISSORS

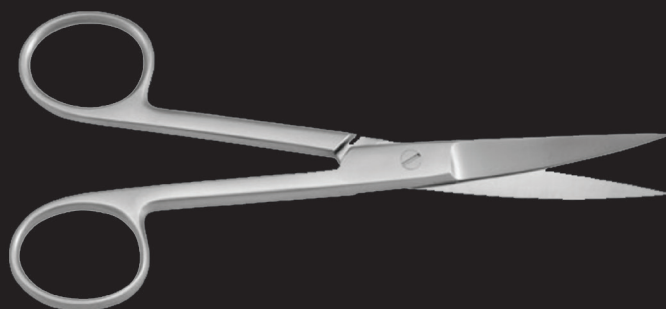
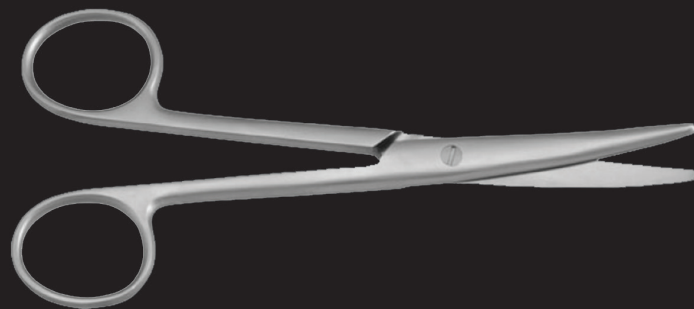
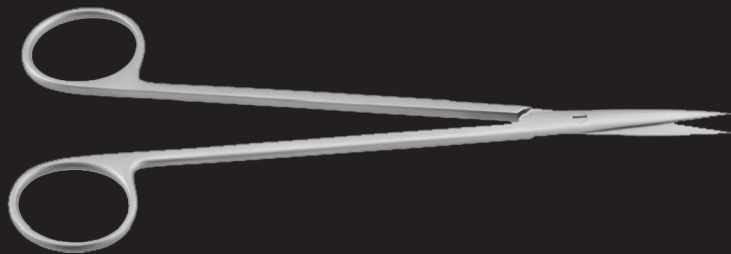

## Index Scissors

## SURGICAL SCISSORS

Standard	9-10
Grazil	10-12
Deaver   Mixer   Richter   Fergusson	12-13
Doyen	13-14
Sims	14-16
Dubois   Wertheim	16
Crafoord   Braun-Stadler   Waldmann	17
Mod. USA   Schumacher	18
Bush	18-19
Mayo	19-21
Resano	21
Lloyd-Davies	22
Stelzner	23
Metzenbaum	24-26
Lillehei-Potts	26
Metzenbaum-Fino-S	27
Lexer   Starbismus	28
Thorek   Gorney   Kilner (Ragnell)	29
Jameson   Reynolds	30
Toennis	30-31
DeBakey   Aufricht   McIndoe	31
Boettcher   Martin   Prince   Dean	32
Good   Potts-Smith   Kahn	33
Salyer   Kaye	34
Fomon   Fomon-Fino	34-35
Cottle   Heymann   Olivecrona	36
Tessier   Knight   Fomon   Landolt	37
Cottle-Masing   Cottle   Wilmer-Walter	38
Kelly   Joseph   Peck-Joseph   Chadwich	39
Quinby   Sanvenero   La Grange	40
Goldmann-Fox   Goldmann-Fox-S	41
Wagner   Wagner-Standard   Kilner   Litler	41-42
Stevens Tenotomy	43
Iris   Iris Standard	43-44
O'Brien	44
Iris-Fino   Iris-Anatomy   Bonn   Graefe	45
Ribbon-Stevens Tenotomy   Ribbon-Iris   Jabaley	46
Satinsky   Bozemann   Klinkenbergh-Loth   Strully	47
Church   Jorgenson   Dandy   Classon	48
Potts-Smith   Locklin	49, 52
Schmieden-Taylor	49
DeBakey   Favaloro	50-51
Potts-De Martel	52
Mills   Dietrich-Hegemann	53
Spencer-Fino   Spencer   Shortbrent   Locklin   Northbent	54
Littauer   Littler   Buck   Eiselsberg   Heath   Schoemaker-Loth	55
Beebee   Guilford-Wright   Universal   Harvey	56

**SUPERCUT SCISSORS**

Standard   Sims	58
Sims-Siebold-S   Waldmann   Mayo	59
Mayo-Harrington   Mayo-Stille	60
Metzenbaum   Metzenbaum-Fino	61
Metzenbaum-Baby   Lexer   Kilner (Ragnell)   Jameson	62
Reynolds   Heymann   Kelly   Stevens Tenotomy	63
Iris   Jabaley	64
Potts-Smith   Dietrich-Hegemann	65

**SCISSORS WITH TUNGSTEN CARBIDE EDGES**

Standard	67
Mixer   Waldmann	68
Sims	69-70
Mayo   Mayo-Harrington   Wertheim	71-72
Mayo-Stille   Metzenbaum   Metzenbaum-Fino   Metzenbaum-Fino-S	73-76
Mayo-Lexer   Lexer   Lexer   Thorek	77
Joseph   Kilner   Jameson   Reynolds	78-79
Metzenbaum-Lahey   Toennis-Adson	79
Dean   Fomon   Cottle	80
Gorney   Fomon   Kaye   Stella	81
Gorney-Freeman   Freeman-Kaye   Freeman-Gorney	82
Kelly   Joseph   Goldman-Fox   Wagner	83
Iris   Locklin   Locklin-S	84
DeBakey   Potts-Smith	85
Dietrich-Hegemann   Universal   Smith	86
Mayo   Metzenbaum	87

**SUPERCUT TITANIUM-NITRIDE SCISSORS**

Sims   Mayo   Mayo-Harrington	89
Mayo-Stille   Metzenbaum	90
Metzenbaum-Fino   Lexer	91
Jameson   Reynolds   Toennis-Adson   Fomon	92
Heymann   Gregory   Kelly   Joseph	93
Stevens Tenotomy   Iris   Dietrich-Hegemann	94
Potts-de Martel	95
Micro Scissors Round Handle   Scissors Flat Handle 18 cm	96-98
Micro Scissors Flat Handle	99
Micro Scissors Round Handle 18 cm	100
Titanium Micro Scissors Bayonet Flat Handle 23 cm	101
Micro Vascular Scissors Flat Handle 7 mm Micro Blades 10 cm	102
Micro Vascular Scissors Flat Handle 10 mm Blades 16 cm   14 mm Blades 12 cm	103
Micro Vascular Scissors Flat Handle 18 cm	104
Micro Vascular Scissors Flat Handle 21 cm	105, 106
Micro Vascular Scissors Round Handle 16 cm	107
Micro Vascular Scissors Round Handle 18 cm	108
Micro Vascular Scissors Round Handle 21 cm	109
Jacobson Micro Scissors Flat Handle Bayonet	110
Jacobson Micro Scissors Flat Handle Bayonet	111

## SCISSORS

## Surgical Scissors

- Every pair of SKILL scissors is manufactured from high-quality cutter-grade steel. Specially tempered blades, consistent hardness and cutting tests to ensure quality before shipping guaranteed outstanding and continuing cutting performance.

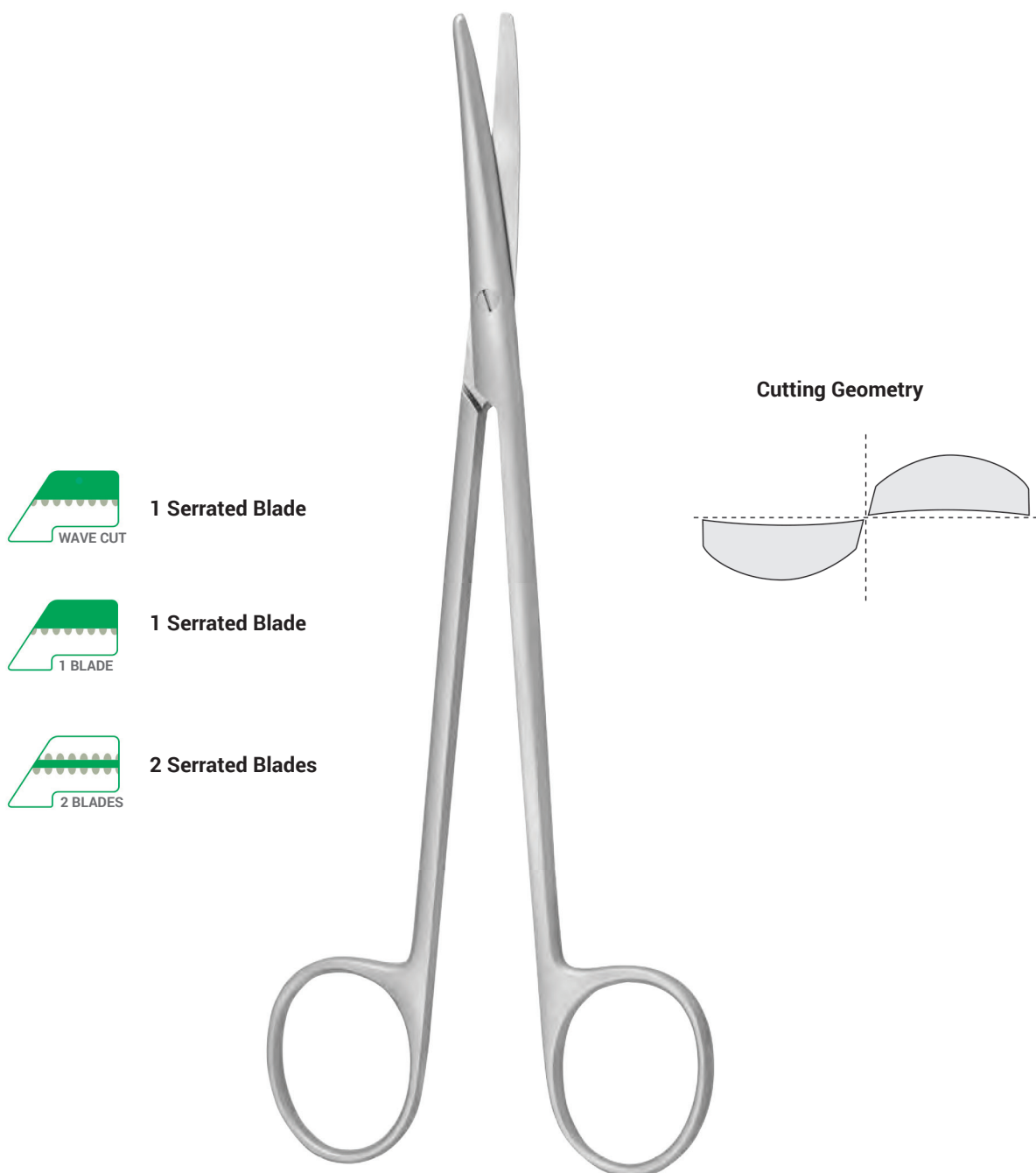



# SCISSORS

## Standard

Fig. 1

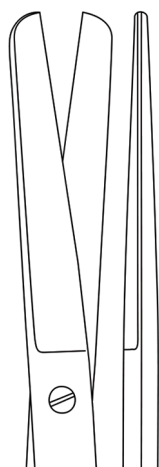

Length	Code
10 cm	BB-0606-10
11 cm	BB-0606-11
13 cm	BB-0606-13
14 cm	BB-0606-14
15 cm	BB-0606-15
16 cm	BB-0606-16
17 cm	BB-0606-17
18 cm	BB-0606-18
20 cm	BB-0606-20

Fig. 1



Length	Code
10 cm	BB-0607-10
11 cm	BB-0607-11
13 cm	BB-0607-13
14 cm	BB-0607-14
15 cm	BB-0607-15
16 cm	BB-0607-16
17 cm	BB-0607-17
18 cm	BB-0607-18
20 cm	BB-0607-20



Fig. 2

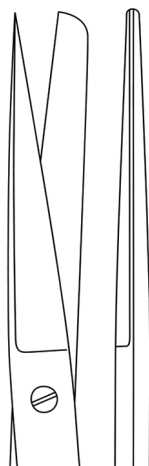

Length	Code
10 cm	BB-0608-10
11 cm	BB-0608-11
13 cm	BB-0608-13
14 cm	BB-0608-14
15 cm	BB-0608-15
16 cm	BB-0608-16
17 cm	BB-0608-17
18 cm	BB-0608-18
20 cm	BB-0608-20

Fig. 2



Length	Code
10 cm	BB-0609-10
11 cm	BB-0609-11
13 cm	BB-0609-13
14 cm	BB-0609-14
15 cm	BB-0609-15
16 cm	BB-0609-16
17 cm	BB-0609-17
18 cm	BB-0609-18
20 cm	BB-0609-20





# SCISSORS

## Standard

Fig. 3

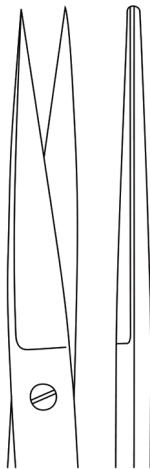

Length	Code
10 cm	BB-0610-10
11 cm	BB-0610-11
13 cm	BB-0610-13
14 cm	BB-0610-14
15 cm	BB-0610-15
16 cm	BB-0610-16
17 cm	BB-0610-17
18 cm	BB-0610-18
20 cm	BB-0610-20

Fig. 3



Length	Code
10 cm	BB-0611-10
11 cm	BB-0611-11
13 cm	BB-0611-13
14 cm	BB-0611-14
15 cm	BB-0611-15
16 cm	BB-0611-16
17 cm	BB-0611-17
18 cm	BB-0611-18
20 cm	BB-0611-20

## Grazil

Fig. 1

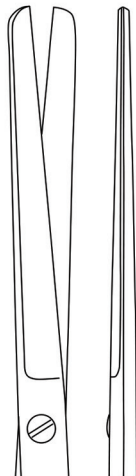

Delicate Pattern

Length	Code
13 cm	BB-0612-13
14 cm	BB-0612-14

Fig. 1

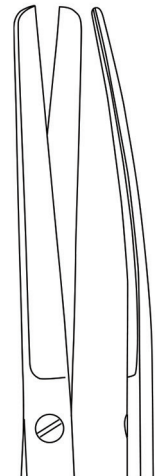

Delicate Pattern

Length	Code
13 cm	BB-0613-13
14 cm	BB-0613-14



**Grazil**

**Fig. 2**

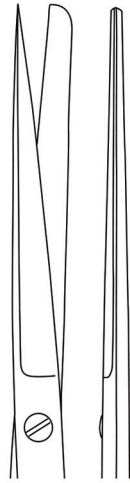

**Delicate Pattern**

**Fig. 2**



**Delicate Pattern**

Length	Code
13 cm	BB-0614-13
14 cm	BB-0614-14

Length	Code
13 cm	BB-0615-13
14 cm	BB-0615-14

**Grazil**

**Fig.3**

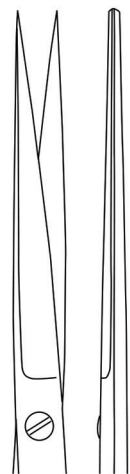

**Delicate Pattern**

**Fig.3**



**Delicate Pattern**

Length	Code
13 cm	BB-0616-13
14 cm	BB-0616-14

Length	Code
13 cm	BB-0617-13
14 cm	BB-0617-14



# SCISSORS

## Grazil

Fig. 2

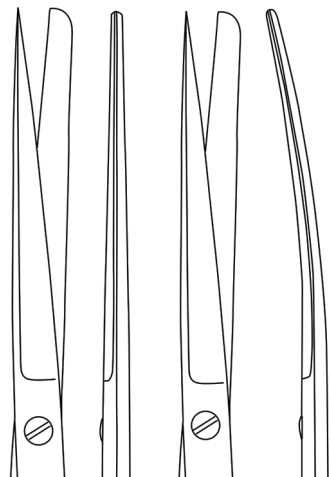

**Code** BB-0618-13      **Code** BB-0619-13

**Delicate Pattern**



**Length**      **Code**  
 13 cm      BB-0618-13  
 13 cm      BB-0619-13

Fig. 2

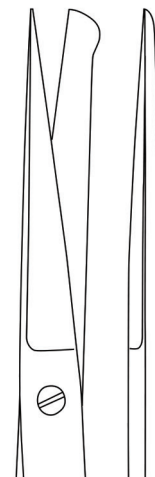

**Incision Scissors**

**Length**      **Code**  
 13 cm      BB-0620-13  
 14 cm      BB-0620-14  
 15 cm      BB-0620-15

## Deaver



**Code** BB-0340-14

**Length**      **Code**  
 13 cm      BB-0340-13

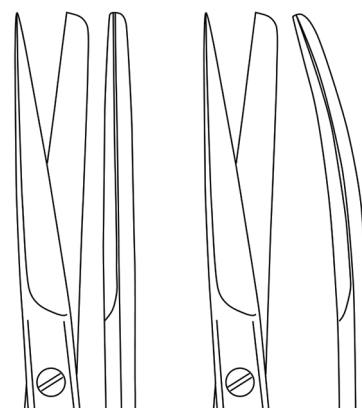

**Code** BB-0334-13      **Code** BB-0334-14

**Length**      **Code**  
 13 cm      BB-0334-13  
 14 cm      BB-0334-14



# SCISSORS

## Mixer

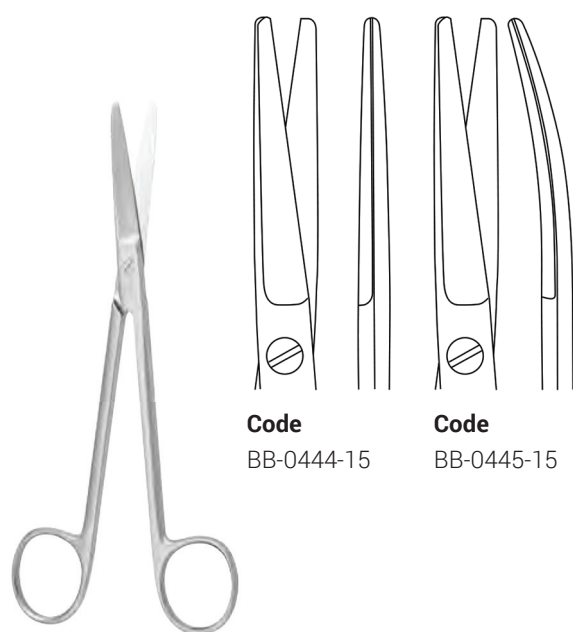

**Code**  
BB-0444-15

**Code**  
BB-0445-15

**Length**    **Code**  
15 cm        BB-0444-15 - BB-0445-15

## Richter

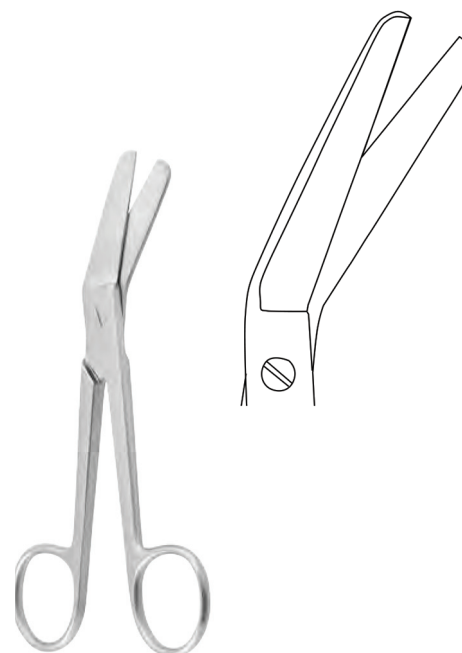

**Length**    **Code**  
14 cm        BB-0450-14

## Fergusson

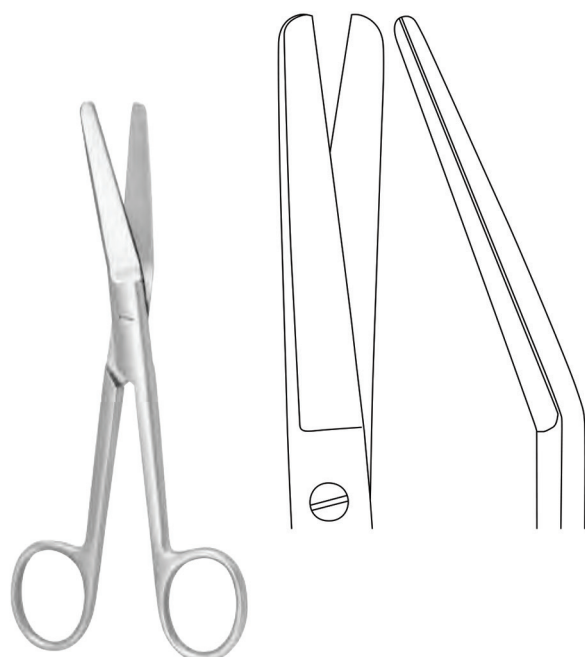

**Length**    **Code**  
16 cm        BB-0551-16  
18 cm        BB-0551-18

## Doyen

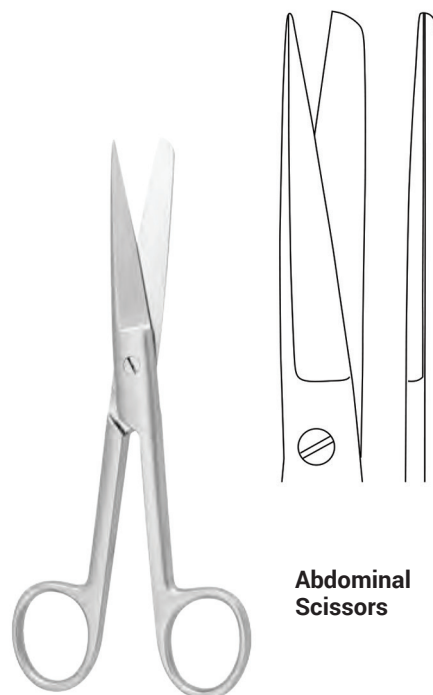

**Abdominal  
Scissors**

**Length**    **Code**  
16 cm        BB-0242-16



**Doyen**

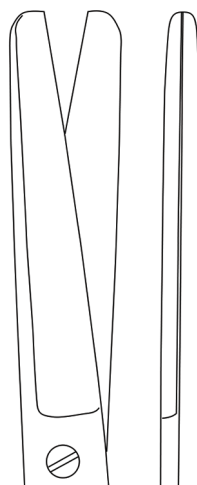

**Code**  
BB-0243-16  
BB-0243-18

**Abdominal Scissors**



**Code**  
BB-0244-16  
BB-0244-18

**Abdominal Scissors**

Length	Code
16 cm	BB-0243-16 - BB-0244-16
18 cm	BB-0243-18 - BB-0244-18

**Sims**



**Code**  
BB-0500-20  
BB-0500-23  
BB-0500-25

**Uterine Scissors**



**Code**  
BB-0509-20  
BB-0509-23  
BB-0509-25

**Uterine Scissors**

Length	Code
20 cm	BB-0500-20 - BB-0509-20
23 cm	BB-0500-23 - BB-0509-23
25 cm	BB-0500-25 - BB-0509-25



Sims

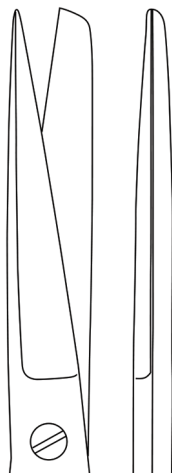

**Code**  
 BB-0510-20  
 BB-0510-23  
 BB-0510-25



**Code**  
 BB-0511-20  
 BB-0511-23  
 BB-0511-25

Uterine Scissors

Uterine Scissors

Length	Code
20 cm	BB-0510-20 - BB-0511-20
23 cm	BB-0510-23 - BB-0511-23
25 cm	BB-0510-25 - BB-0511-25



**Code**  
 BB-0512-20  
 BB-0512-23  
 BB-0512-25



**Code**  
 BB-0513-20  
 BB-0513-23  
 BB-0513-25

Uterine Scissors

Uterine Scissors

Length	Code
20 cm	BB-0512-20 - BB-0513-20
23 cm	BB-0512-23 - BB-0513-23
25 cm	BB-0512-25 - BB-0513-25

# SCISSORS

## Uterine Scissors, Decapitating Scissors



### Dubois

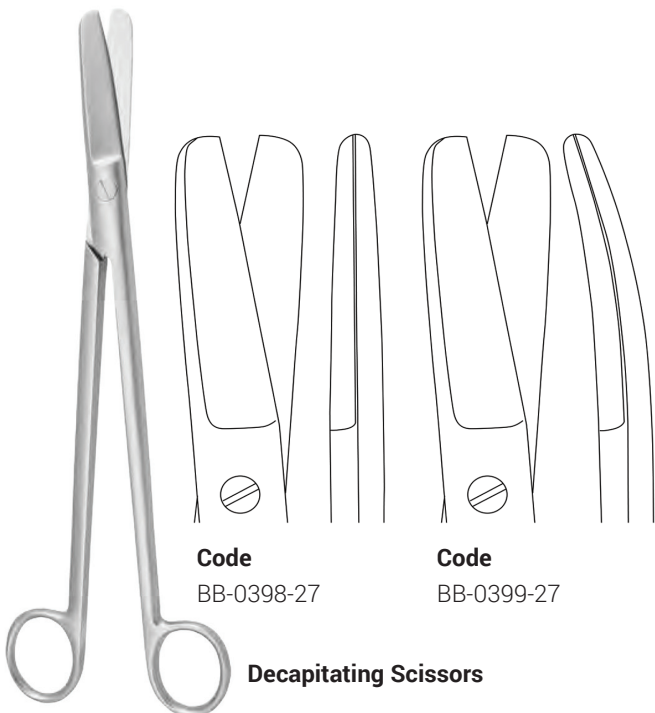

**Code**  
BB-0398-27

**Code**  
BB-0399-27

**Decapitating Scissors**

Length	Code
27 cm	BB-0398-27 - BB-0399-27

### Wertheim

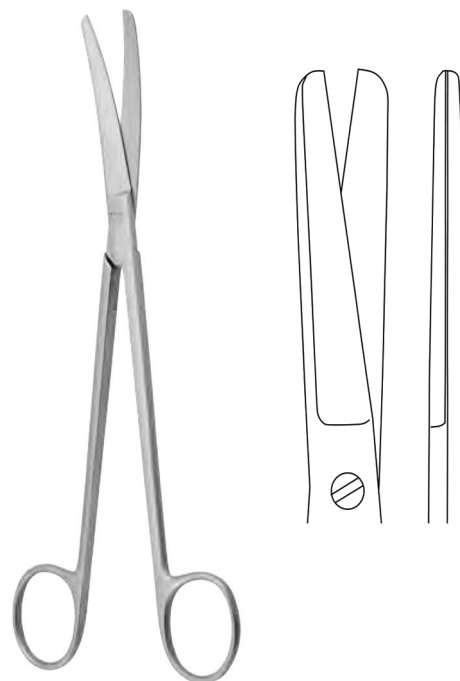

Length	Code
14 cm	BB-0383-14
20 cm	BB-0383-20
22 cm	BB-0383-22

### Sims Siebold-S

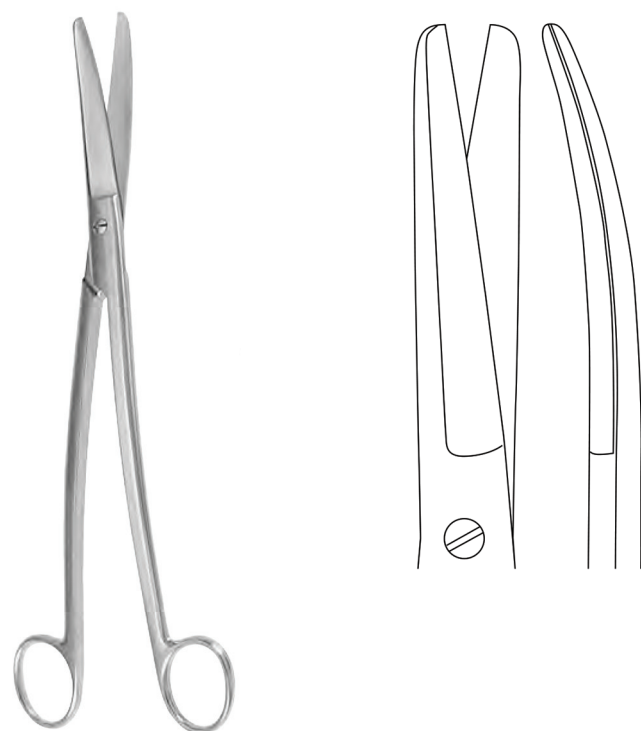

Length	Code
24 cm	BB-0990-24

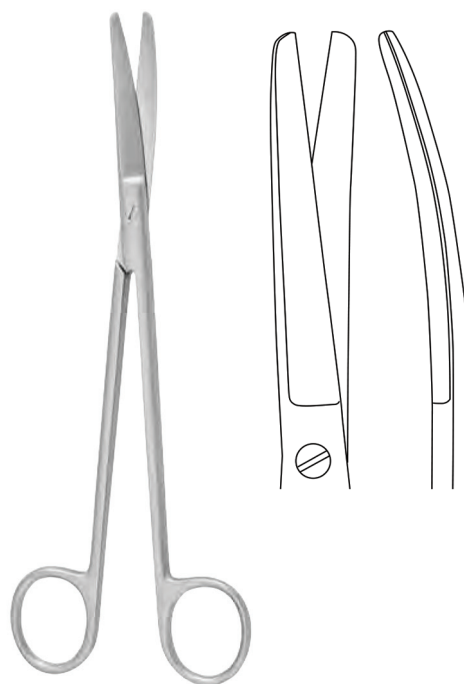

Length	Code
14 cm	BB-0384-14
20 cm	BB-0386-20
22 cm	BB-0387-22



# SCISSORS

## Crafoord

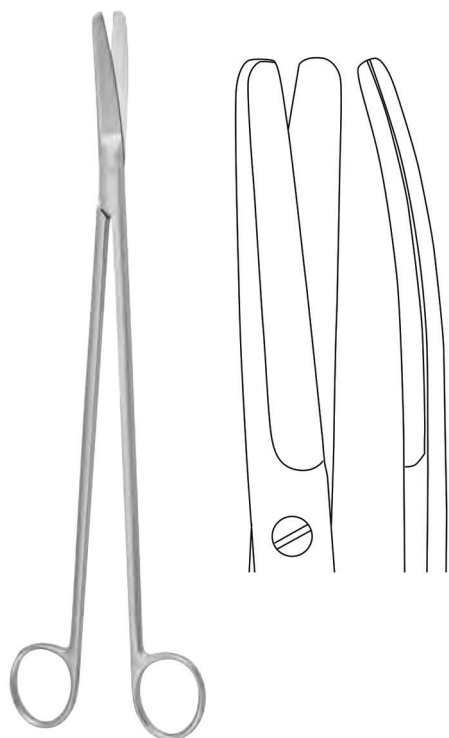

Length	Code
30 cm	BB-0382-30

## Braun-Stadler



Perineum Scissors  
(Episiotomy)

Length	Code
14 cm	BB-0390-14
22 cm	BB-0390-22

## Waldmann

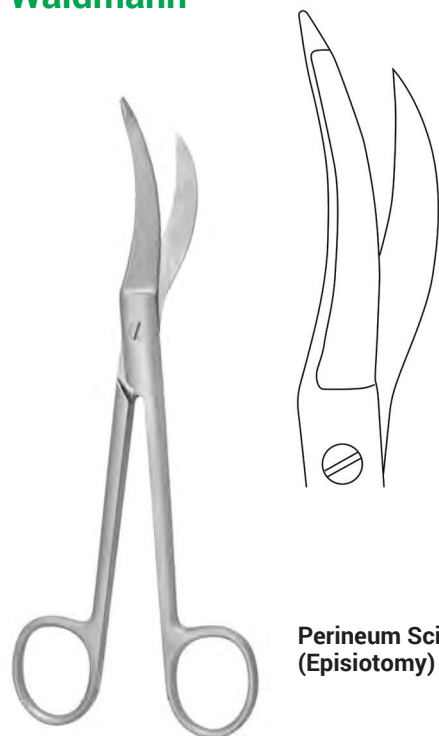

Perineum Scissors  
(Episiotomy)

Length	Code
18 cm	BB-0396-18

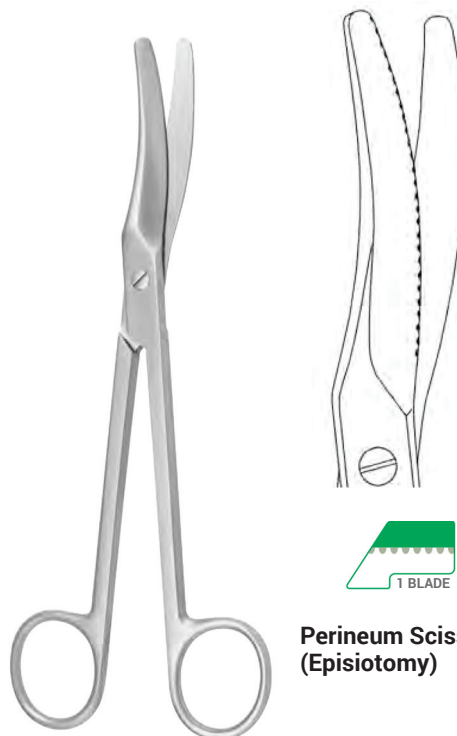

Perineum Scissors  
(Episiotomy)

Length	Code
18 cm	BB-0397-18



# SCISSORS

Surgical Scissors



**Mod. USA**

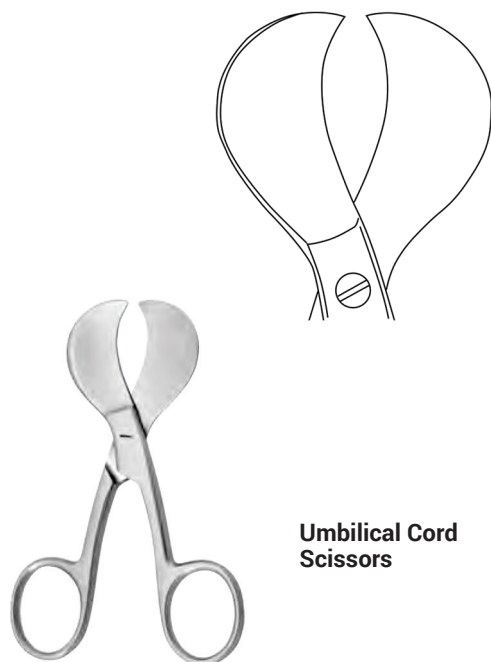

**Umbilical Cord Scissors**

Length	Code
10 cm	BB-0398-10

**Schumacher**

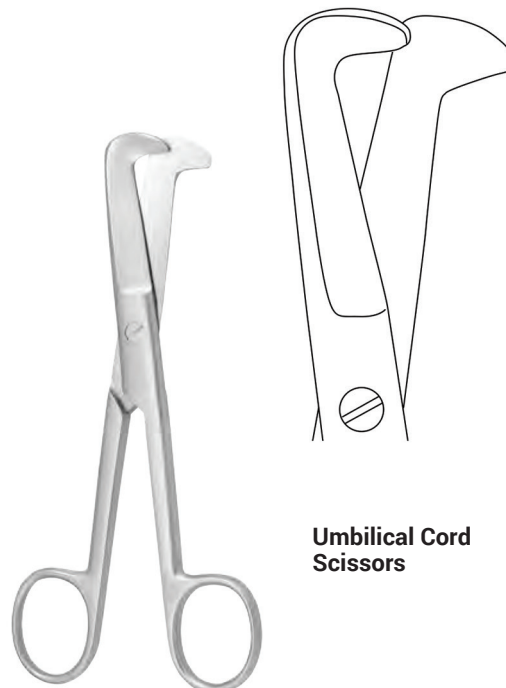

**Umbilical Cord Scissors**

Length	Code
16 cm	BB-0006-16

**Bush**



**Umbilical Cord Scissors**

Length	Code
13 cm	BB-0003-13
16 cm	BB-0003-16

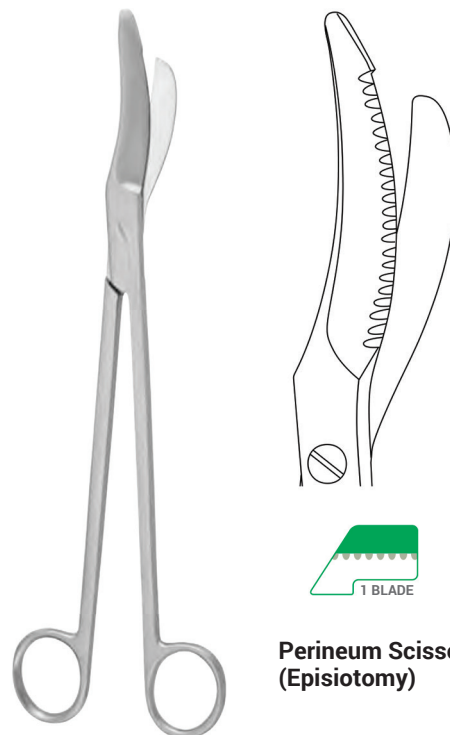

**Perineum Scissors (Episiotomy)**

Length	Code
24 cm	BB-0004-24

Enterotomy Scissors, Surgical Scissors



SCISSORS

Bush



Length	Code
21 cm	BB-0005-21



Length	Code
21 cm	BB-0006-21



Length	Code
21 cm	BB-0007-21

Mayo

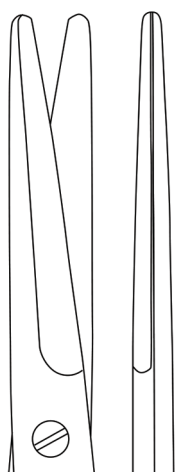

Length	Code
14 cm	BB-0366-14
15 cm	BB-0366-15
17 cm	BB-0366-17
19 cm	BB-0366-19
23 cm	BB-0366-23
30 cm	BB-0366-30



Length	Code
14 cm	BB-0369-14
15 cm	BB-0369-15
17 cm	BB-0369-17
19 cm	BB-0369-19
23 cm	BB-0369-23
30 cm	BB-0369-30



# SCISSORS

## Mayo-Stille

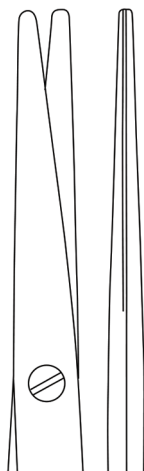

Length	Code
15 cm	BB-0360-15
17 cm	BB-0360-17
19 cm	BB-0360-19
21 cm	BB-0360-21
23 cm	BB-0360-23



Length	Code
15 cm	BB-0361-15
17 cm	BB-0361-17
19 cm	BB-0361-19
21 cm	BB-0361-21
23 cm	BB-0361-23

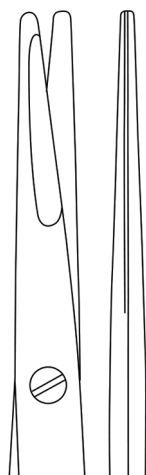

**Chamfered Blades**

Length	Code
14 cm	BB-0362-14
17 cm	BB-0362-17
19 cm	BB-0362-19
21 cm	BB-0362-21



**Chamfered Blades**

Length	Code
14 cm	BB-0363-14
17 cm	BB-0363-17
19 cm	BB-0363-19
21 cm	BB-0363-21



# SCISSORS

## Mayo-Harrington

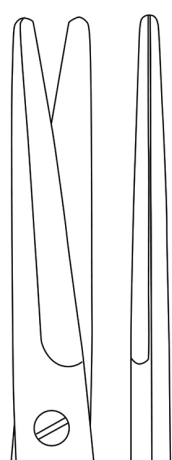
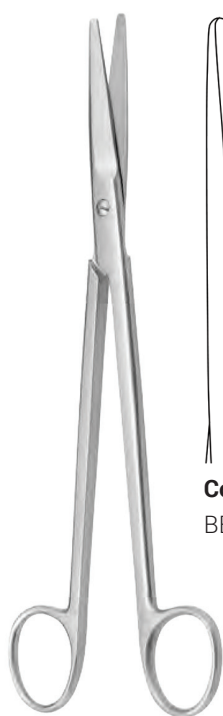

**Code**  
BB-0371-22

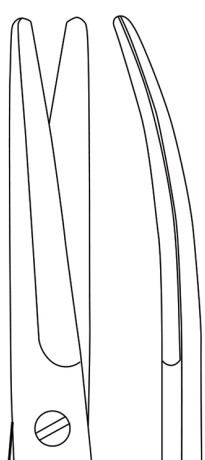

**Code**  
BB-0372-22

**Length**    **Code**  
22 cm        BB-0371-22 - BB-0372-22

## Mayo-Noble

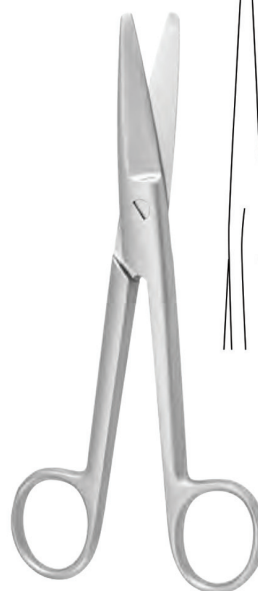

**Length**    **Code**  
17 cm        BB-0972-17

## Resano

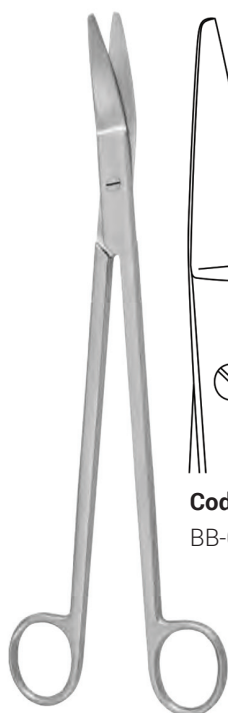

**Code**  
BB-0975-24



**Code**  
BB-0976-24

**Capsula scissors**

**Length**    **Code**  
24 cm        BB-0975-24 - BB-0976-24

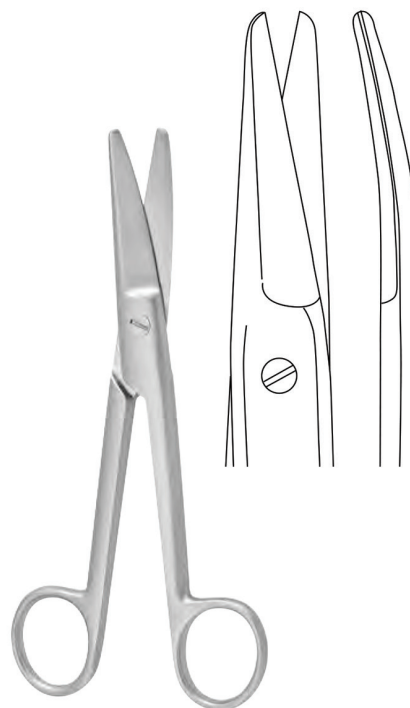

**Length**    **Code**  
17 cm        BB-0974-17



# SCISSORS

## Lloyd-Davies



Length	Code
26 cm	BB-0958-26

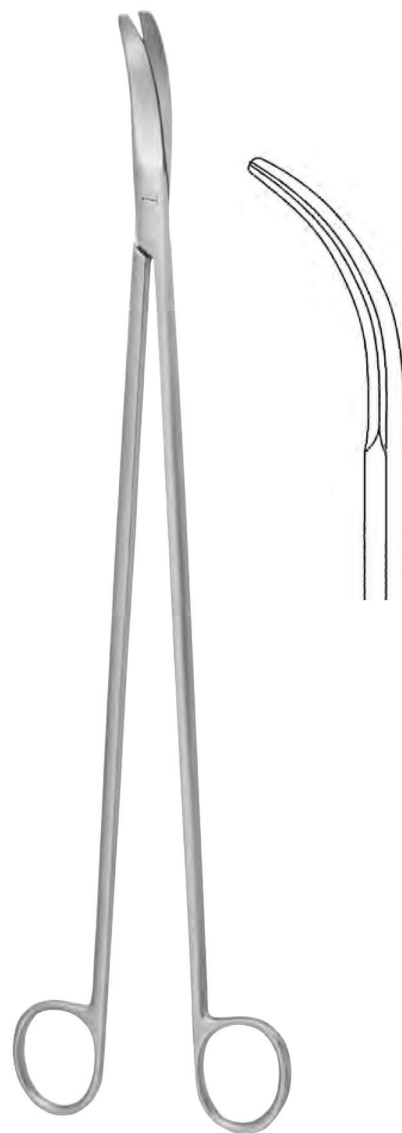

Length	Code
26 cm	BB-0959-26





Stelzner



**Code**  
BB-0952-31



**Code**  
BB-0954-31

Length	Code
31 cm	BB-0952-31 - BB-0954-31

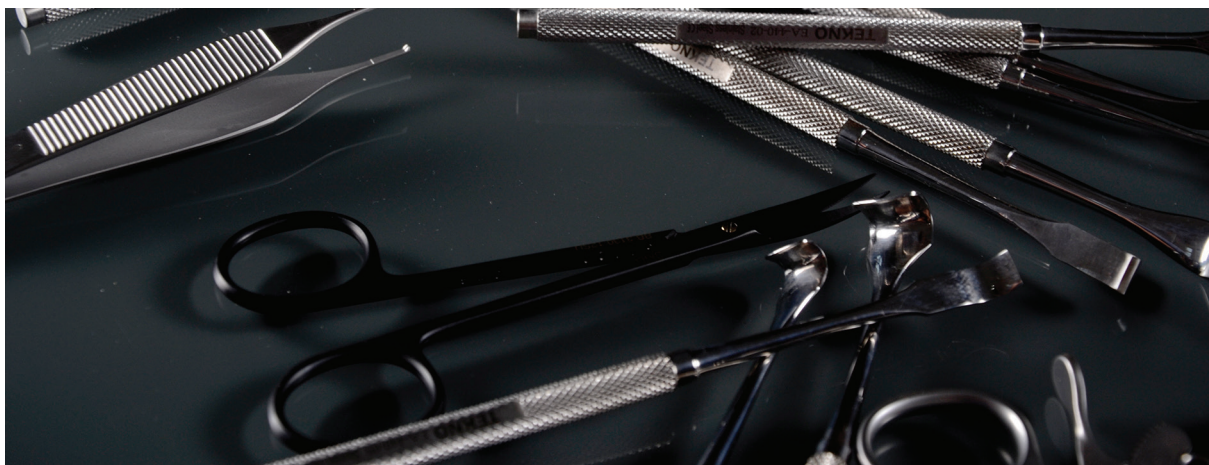



Metzenbaum

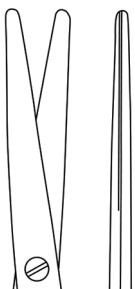

Length	Code
14 cm	BB-0200-14
18 cm	BB-0200-18
20 cm	BB-0200-20
23 cm	BB-0200-23
25 cm	BB-0200-25
28 cm	BB-0200-28
30 cm	BB-0200-30
36 cm	BB-0200-36



Length	Code
14 cm	BB-0201-14
18 cm	BB-0201-18
20 cm	BB-0201-20
23 cm	BB-0201-23
25 cm	BB-0201-25
28 cm	BB-0201-28
30 cm	BB-0201-30
36 cm	BB-0201-36

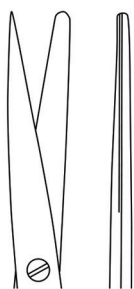

Length	Code
14 cm	BB-0182-14
18 cm	BB-0182-18
20 cm	BB-0182-20

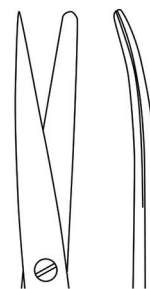

Length	Code
14 cm	BB-0183-14
18 cm	BB-0183-18
20 cm	BB-0183-20



Metzenbaum

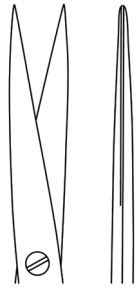

Length	Code
14 cm	BB-0185-14
18 cm	BB-0185-18
20 cm	BB-0185-20
23 cm	BB-0185-23

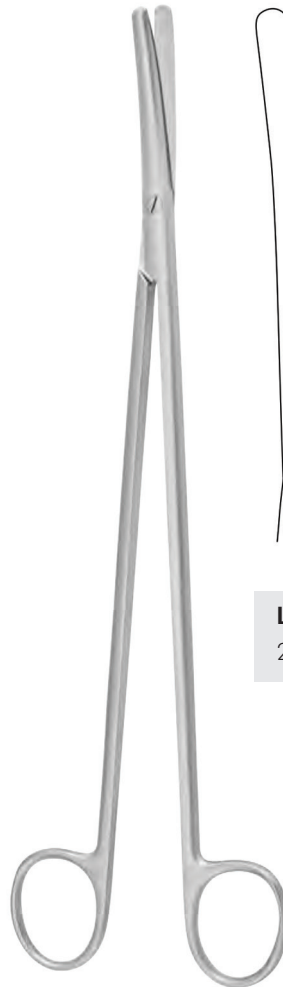

Length	Code
28 cm	BB-0220-28

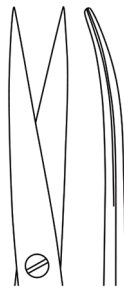

Length	Code
14 cm	BB-0182-14

# SCISSORS

## Metzenbaum-Fino

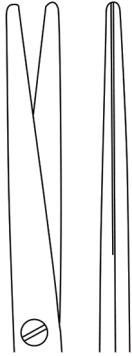

Length	Code
12 cm	BB-0197-12
14 cm	BB-0197-14
18 cm	BB-0197-18
20 cm	BB-0197-20
23 cm	BB-0197-23
25 cm	BB-0197-25

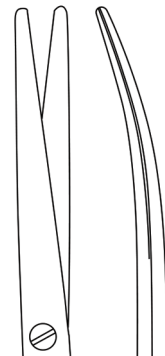

Length	Code
12 cm	BB-0198-12
14 cm	BB-0198-14
18 cm	BB-0198-18
20 cm	BB-0198-20
23 cm	BB-0198-23
25 cm	BB-0198-25
28 cm	BB-0198-28
30 cm	BB-0198-30

## Lillehei-Potts

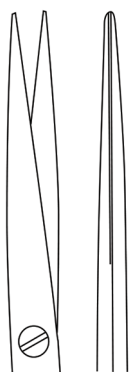
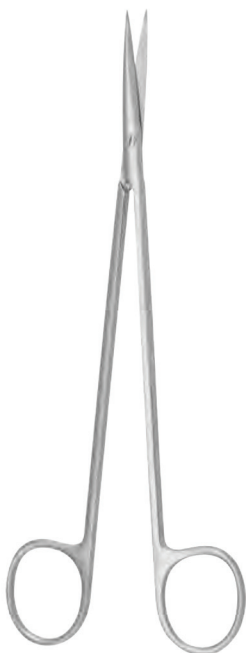

Length	Code
14 cm	BB-0239-14
18 cm	BB-0239-18
20 cm	BB-0239-20
23 cm	BB-0239-23



Length	Code
14 cm	BB-0240-14
18 cm	BB-0240-18
20 cm	BB-0240-20
23 cm	BB-0240-23



Metzenbaum-Fino-S



Length	Code
14 cm	BB-0172-14
18 cm	BB-0172-18
20 cm	BB-0172-20
23 cm	BB-0172-23
25 cm	BB-0172-25

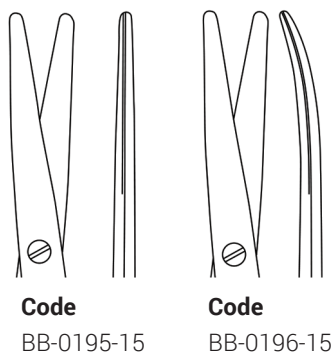

**Code**  
BB-0195-15

**Code**  
BB-0196-15

**Short Blades**

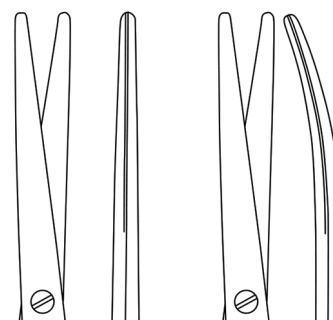

**Code**  
BB-0197-11

**Code**  
BB-0198-11

**Length**  
15 cm

**Code**  
BB-0195-15 - BB-0196-15

**Length**  
11 cm

**Code**  
BB-0197-11 - BB-0198-11

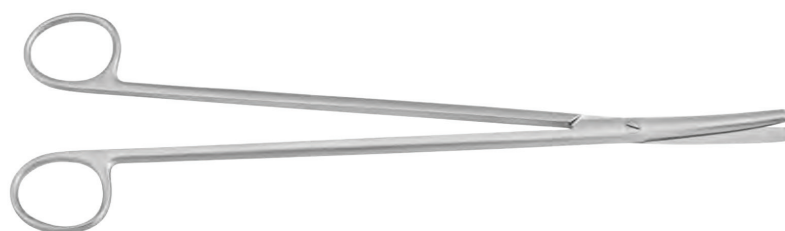



**Lexer**

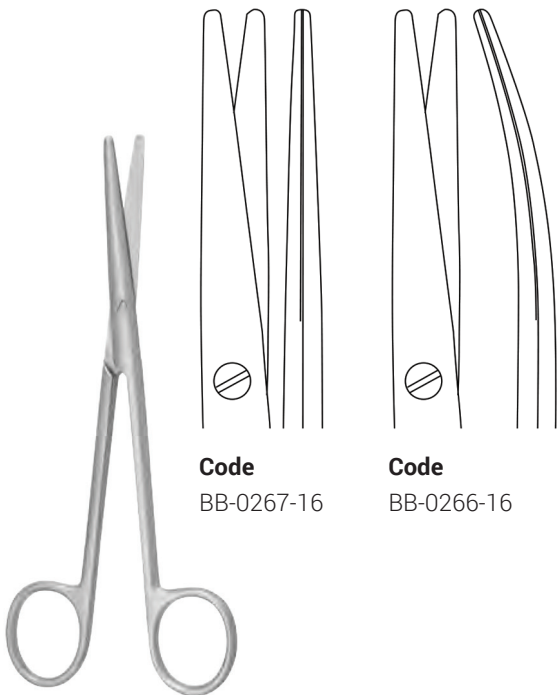

**Code**  
BB-0267-16

**Code**  
BB-0266-16

**Length**    **Code**  
16 cm        BB-0267-16 - BB-0266-16

**Lexer-Fino**



**Code**  
BB-0268-16

**Code**  
BB-0269-16

**Length**    **Code**  
16 cm        BB-0268-16 - BB-0269-16

**Lexer-Baby**

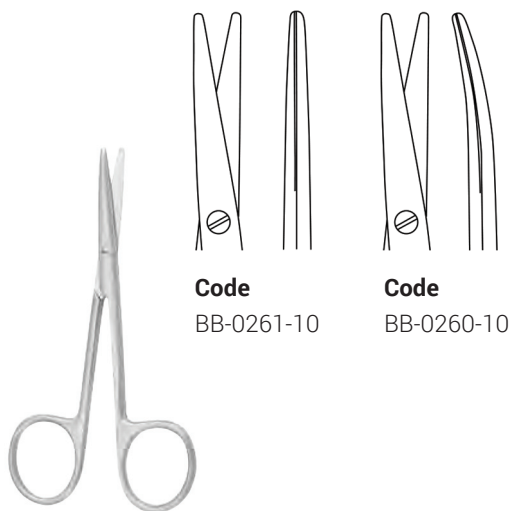

**Code**  
BB-0261-10

**Code**  
BB-0260-10

**Length**    **Code**  
10 cm        BB-0261-10 - BB-0260-10

**Starbismus**

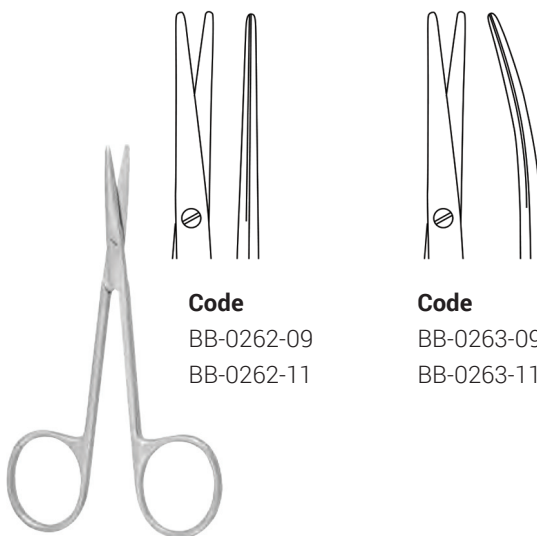

**Code**  
BB-0262-09  
BB-0262-11

**Code**  
BB-0263-09  
BB-0263-11

**Length**    **Code**  
09 cm        BB-0262-09 - BB-0263-09  
11 cm        BB-0262-11 - BB-0263-11



**Thorek**



Length	Code
19 cm	BB-BB-0304--19
25 cm	BB-BB-0304--25

**Gorney**

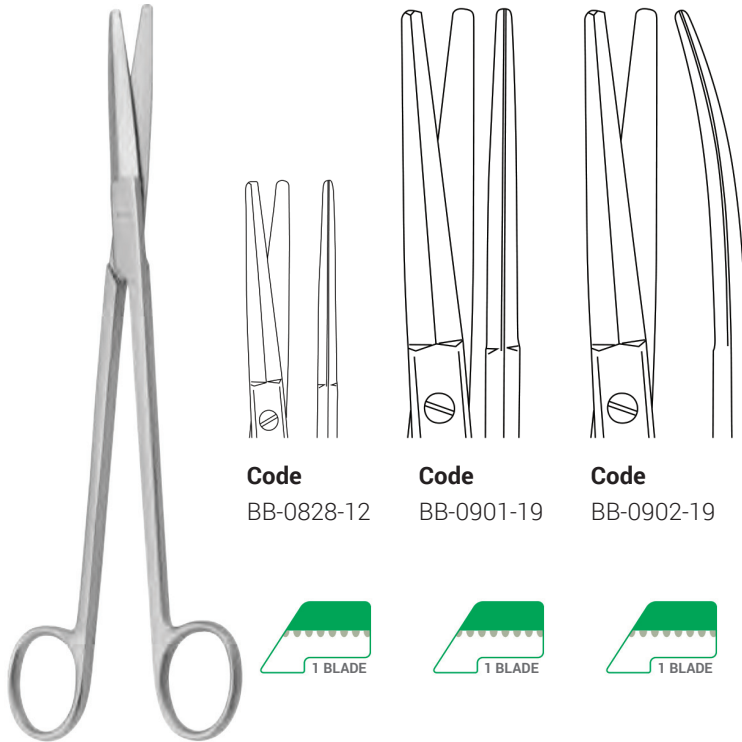

Length	Code
12 cm	BB-0828-12
19 cm	BB-0901-19 - BB-0902-19

**Code**  
BB-0828-12

**Code**  
BB-0901-19

**Code**  
BB-0902-19



**Kilner (Ragnell)**



Length	Code
12 cm	BB-0299-12
14 cm	BB-0299-14



Length	Code
12 cm	BB-0300-12
14 cm	BB-0300-14
18 cm	BB-0300-18
20 cm	BB-0300-20

# SCISSORS

## Dissecting Scissors



### Jameson



**Code**  
BB-0312-13  
BB-0312-15

Length	Code
13 cm	BB-0312-13
15 cm	BB-0312-15

### Reynolds

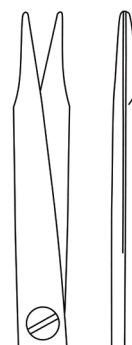

**Code**  
BB-0313-13  
BB-0313-15  
BB-0313-18

**Code**  
BB-0314-13  
BB-0314-15  
BB-0314-18

Length	Code
13 cm	BB-0313-13 - BB-0314-13
15 cm	BB-0313-15 - BB-0314-15
18 cm	BB-0313-18 - BB-0314-18

### Toennis

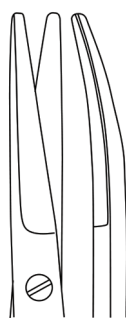
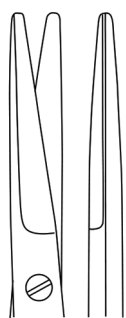
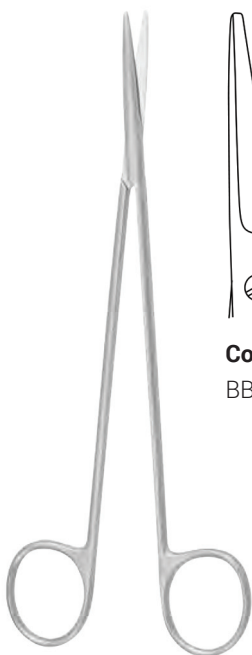

**Code**  
BB-0294-18

**Code**  
BB-0295-18

Length	Code
18 cm	BB-0294-18 - BB-0295-18

### Toennis-Fino



Length	Code
18 cm	BB-0296-18



# SCISSORS

## Toennis-Adson



**Code**  
BB-0297-17



**Code**  
BB-0298-17

**Dissecting Scissors**

**Length**    **Code**  
17 cm      BB-0297-17 - BB-0298-17

## DeBakey



**Code**  
BB-0299-17

**Dissecting Scissors**

**Length**    **Code**  
17 cm      BB-0299-17

## Aufricht

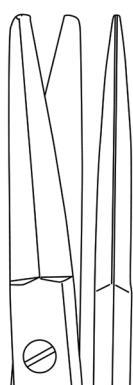

**Code**  
BB-0898-15

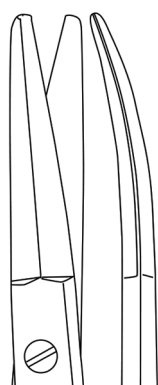

**Code**  
BB-0899-15

**Plastic Surgery Scissors**

**Length**    **Code**  
15 cm      BB-0898-15 - BB-0899-15

## McIndoe

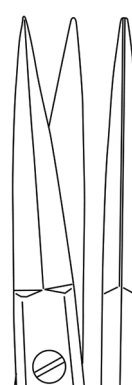
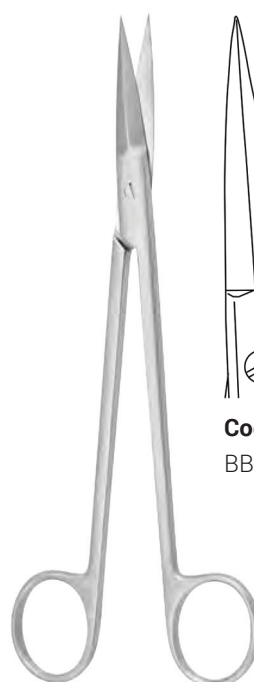

**Code**  
BB-0900-19

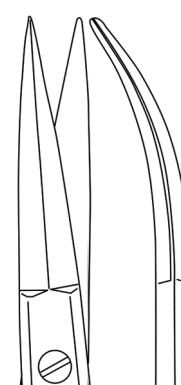

**Code**  
BB-0901-19

**Cartilage Scissors**

**Length**    **Code**  
19 cm      BB-0900-19 - BB-0901-19



**Boettcher**

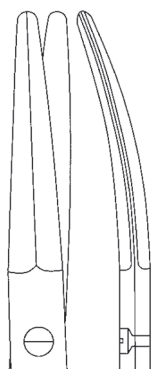

**Tonsil Scissors**

**Length** 18 cm  
**Code** BB-0245-18

**Martin**

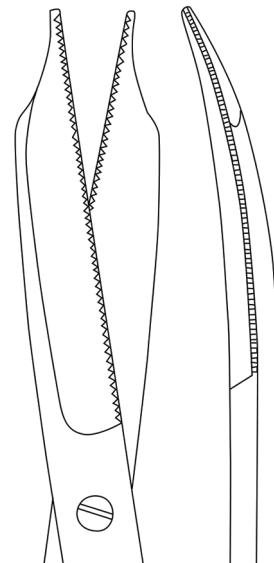

**Cartilage Scissors**

**Length** 20 cm  
**Code** BB-0307-18



**Prince**

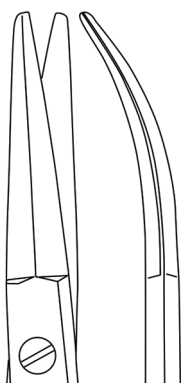

**Tonsil Scissors**

**Length** 17 cm  
**Code** BB-0246-17

**Dean**

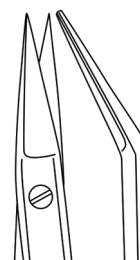

**Code**  
BB-0250-17

**Code**  
BB-0251-17



**Tonsil Scissors**

**Length** 17 cm  
**Code** BB-0250-17 - BB-0251-17



**Good**

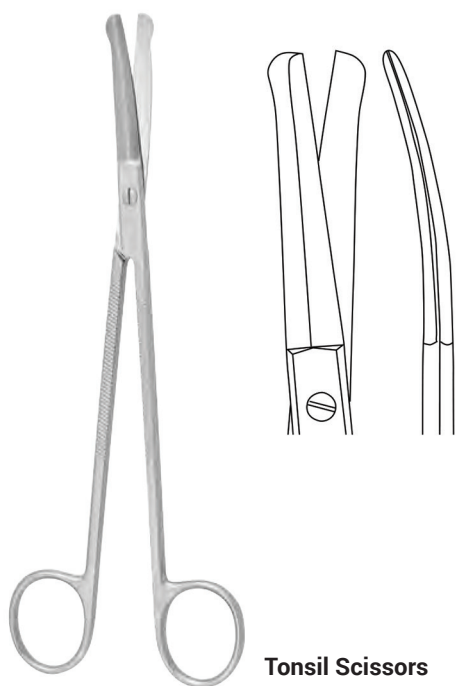

Tonsil Scissors

Length	Code
19 cm	BB-0248-19

**Good-Schwekendieck**

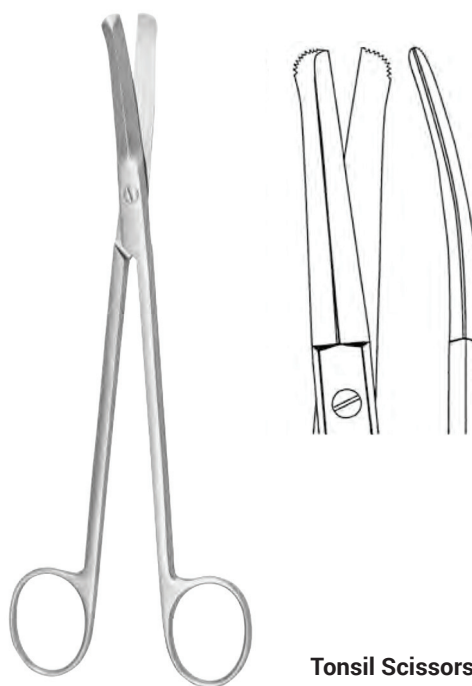

Tonsil Scissors

Length	Code
19 cm	BB-0249-19

**Potts-Smith**

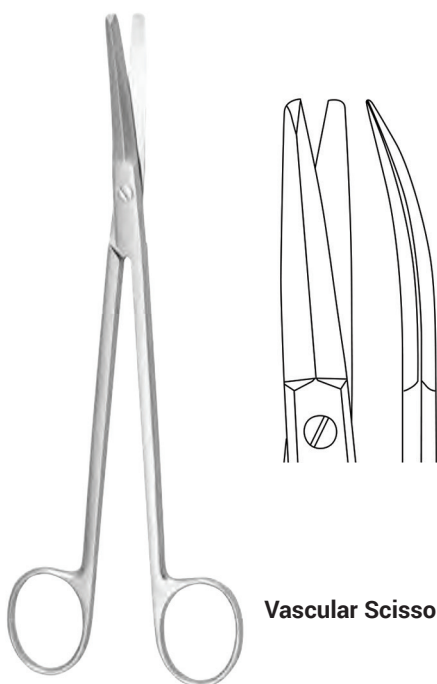

Vascular Scissors

Length	Code
19 cm	BB-0293-19

**Kahn**

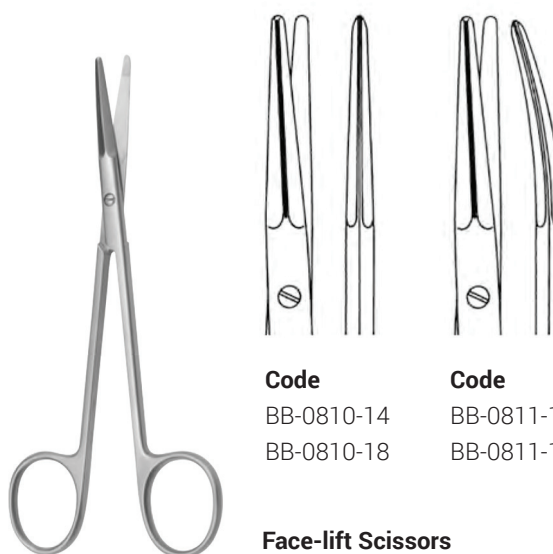

Code	Code
BB-0810-14	BB-0811-14
BB-0810-18	BB-0811-18

Face-lift Scissors

Length	Code
14 cm	BB-0810-14 - BB-0811-14
18 cm	BB-0810-18 - BB-0811-18



**Salyer**



Face-lift Scissors

**Length** 9 cm  
**Code** BB-0864-09



Face-lift Scissors

**Length** 10 cm  
**Code** BB-0865-10

**Kaye**



Face-lift Scissors

**Length** 11 cm  
**Code** BB-0866-11

**Fomon**



Nasal Scissors

**Length** 13 cm  
**Code** BB-0946-13

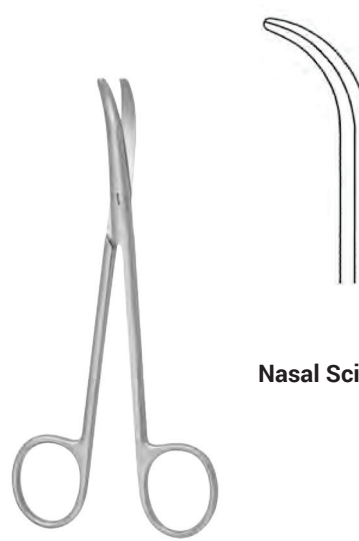

Nasal Scissors

**Length** 13 cm  
**Code** BB-0947-13

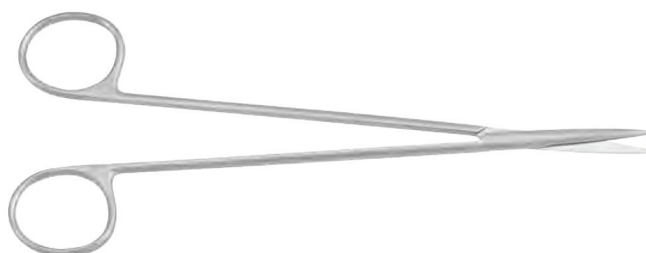



# SCISSORS

**Fomon-Fino**

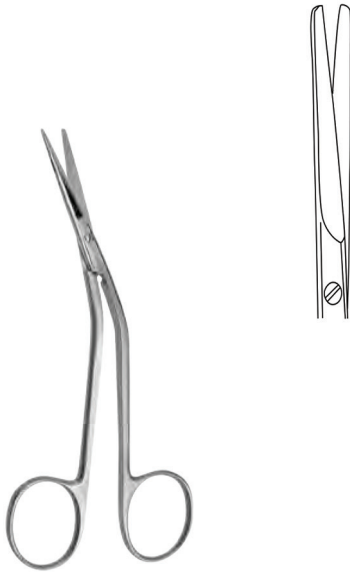

Length	Code
13 cm	BB-0236-13

**Fomon**

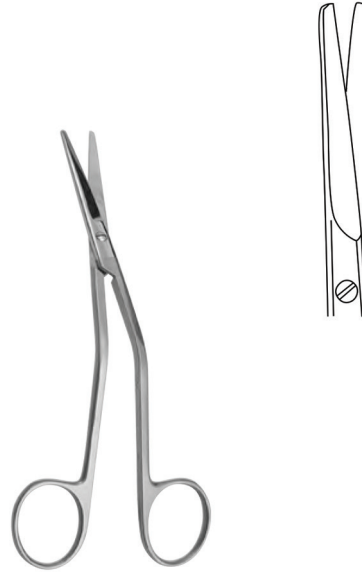

Length	Code
14 cm	BB-0327-14

**Fomon**

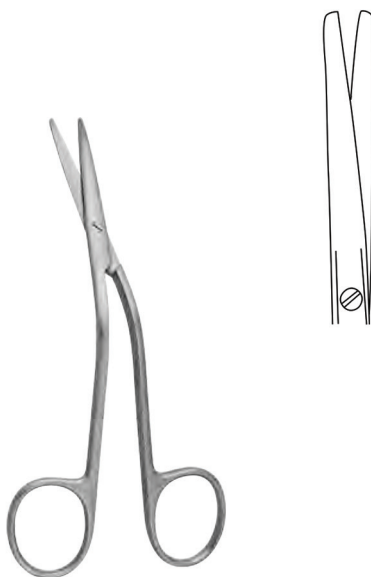

Length	Code
13 cm	BB-0328-13

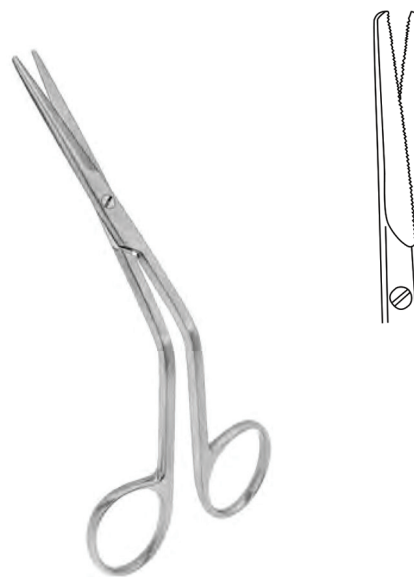

Length	Code
15 cm	BB-0329-15

# SCISSORS

Nasal Scissors 

**Cottle**



Length	Code
16 cm	BB-0328-16

**Heymann**



Length	Code
17cm	BB-0320-17
18 cm	BB-0320-18
20 cm	BB-0320-20

**Heymann**

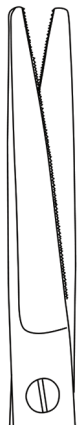
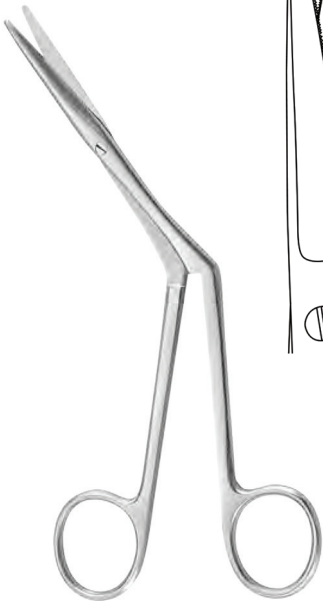

Length	Code
18 cm	BB-0321-18

**Olivecrona**



Length	Code
23 cm	BB-0323-23



# SCISSORS

## Tessier

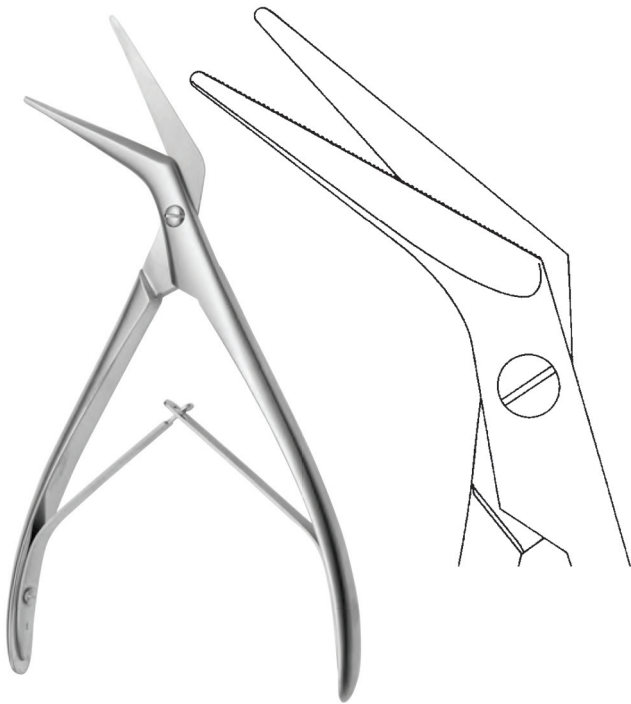

<b>Length</b>	<b>Code</b>
20 cm	BB-0305-20

## Knight



<b>Length</b>	<b>Code</b>
18 cm	BB-0306-18

## Fomon



<b>Length</b>	<b>Code</b>
11 cm	BB-0945-11

## Landolt



**Code**  
BB-0307-11

**Code**  
BB-0307-12

<b>Length</b>	<b>Code</b>
11 cm	BB-0307-11
12 cm	BB-0307-12



**Cottle-Masing**

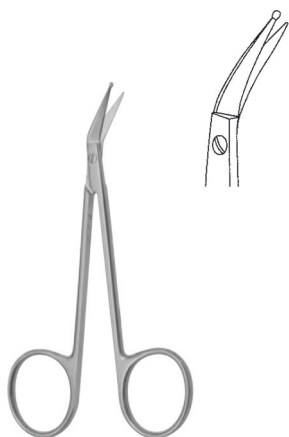

**Length** 10 cm  
**Code** BB-0650-10

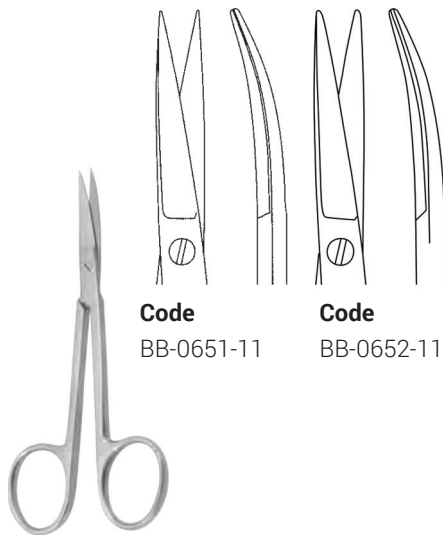

**Length** 11 cm  
**Code** BB-0651-11 - BB-0652-11

**Cottle**

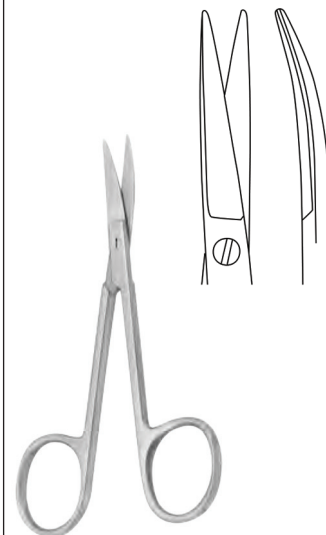

**Length** 12cm  
**Code** BB-0653-12

**Cottle-Knapp**



**Length** 11 cm  
**Code** BB-0654-11 - BB-0655-11

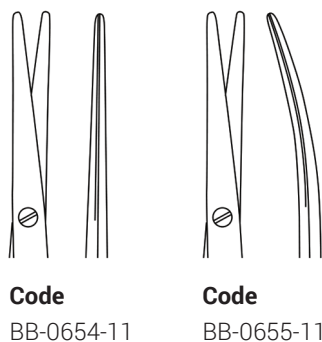

**Code** BB-0654-11  
**Code** BB-0655-11

**Wilmer-Walter**

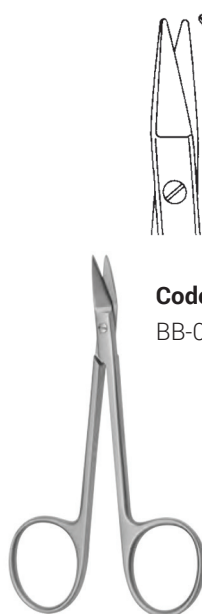

**Length** 10 cm  
**Code** BB-0656-10 - BB-0657-10

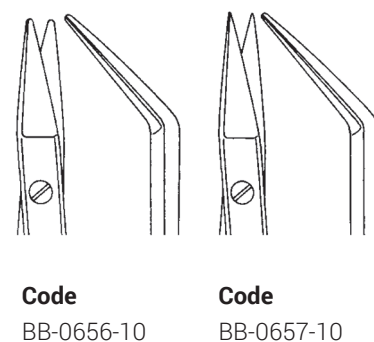

**Code** BB-0656-10  
**Code** BB-0657-10

Delicate Surgical Scissors



SCISSORS

Kelly

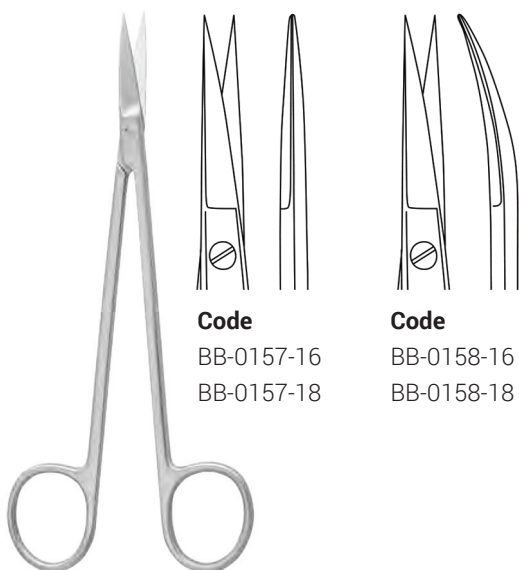

Code

BB-0157-16  
BB-0157-18

Code

BB-0158-16  
BB-0158-18

Length

16 cm  
18 cm

Code

BB-0157-16 - BB-0158-16  
BB-0157-18 - BB-0158-18

Joseph

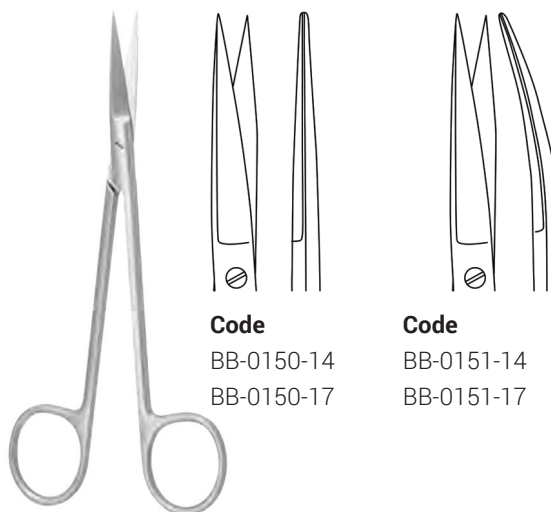

Code

BB-0150-14  
BB-0150-17

Code

BB-0151-14  
BB-0151-17

Length

14 cm  
17 cm

Code

BB-0150-14 - BB-0151-14  
BB-0150-17 - BB-0151-17

Peck-Joseph

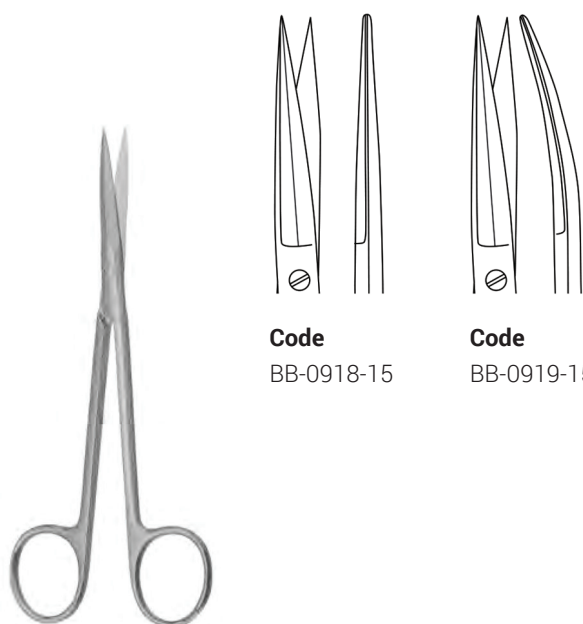

Code

BB-0918-15

Code

BB-0919-15

Length

15 cm

Code

BB-0918-15 - BB-0919-15

Chadwick



Length

11 cm

Code

BB-0539-11

# SCISSORS

## Delicate Surgical Scissors



### Quinby



**Code**  
BB-0525-13



**Code**  
BB-0526-13

**Gum Scissors**

Length	Code
13 cm	BB-0525-13 - BB-0526-13

### Sanvenero



**Code**  
BB-0148-14



**Code**  
BB-0149-14

Length	Code
14 cm	BB-0148-14 - BB-0149-14

### Sanvenero

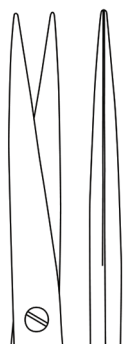
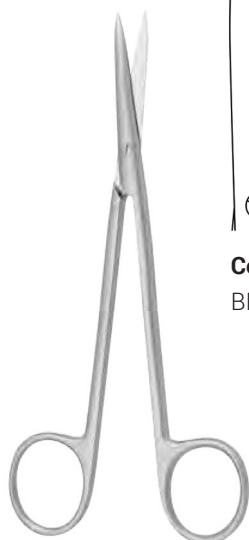

**Code**  
BB-0660-15



**Code**  
BB-0661-15

Length	Code
15 cm	BB-0660-15 - BB-0661-15

### La Grange

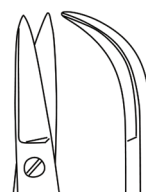

**Gum Scissors**

Length	Code
11 cm	BB-0540-11

Delicate Surgical Scissors



SCISSORS

Goldmann-Fox

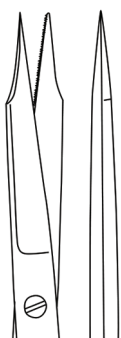

**Code**  
BB-0520-13

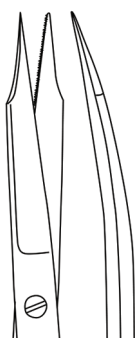

**Code**  
BB-0521-13



1 BLADE



1 BLADE



Gum Scissors

**Length** 13 cm  
**Code** BB-0520-13 - BB-0521-13

Goldmann-Fox-S

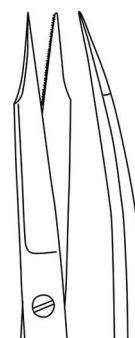

Gum Scissors

**Length** 12 cm  
**Code** BB-0522-12

Goldmann-Fox



**Code**  
BB-0523-11



**Code**  
BB-0524-11



**Length** 11 cm  
**Code** BB-0523-11 - BB-0524-11

Wagner



**Code**  
BB-0750-12



**Code**  
BB-0751-12



Flat Screw Lock

**Length** 12 cm  
**Code** BB-0750-12 - BB-0751-12



Wagner-Standard



Fig. 1

**Code**  
BB-0751-12



Fig. 1

**Code**  
BB-0752-12



Fig. 2

**Code**  
BB-0753-12



Fig. 2

**Code**  
BB-0754-12

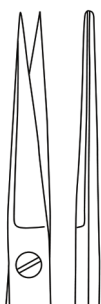

Fig. 3

**Code**  
BB-0755-12



Fig. 3

**Code**  
BB-0756-12

Length	Code
12 cm	BB-0751-12 - BB-0752-12 - BB-0753-12 - BB-0754-12 - BB-0755-12 - BB-0756-12

Kilner



**Code**  
BB-0303-11



**Code**  
BB-0304-11

Length	Code
11 cm	BB-0303-11 - BB-0304-11

Littler



**Code**  
BB-0854-12  
BB-0854-14

Length	Code
12 cm	BB-0854-12
14 cm	BB-0854-14



Stevens Tenotomy

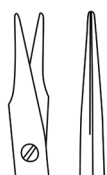

Fig. 1

Code

BB-0167-12  
BB-0167-13  
BB-0167-18



Fig. 1

Code

BB-0168-12  
BB-0168-13  
BB-0168-18

Length

Code

12 cm	BB-0167-12 - BB-0168-12
13 cm	BB-0167-13 - BB-0168-13
18 cm	BB-0167-18 - BB-0168-18

Iris

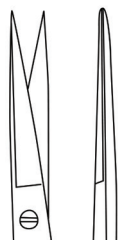

Length

Code

09 cm	BB-0110-09
10 cm	BB-0110-10
11 cm	BB-0110-11



Length

Code

09 cm	BB-0111-09
10 cm	BB-0111-10
11 cm	BB-0111-11



# SCISSORS

## Delicate Surgical Scissors



### Iris



**Code**  
BB-0113-11



**Code**  
BB-0112-11

Length	Code
11 cm	BB-0113-11 - BB-0112-11

### O'Brien



Length	Code
09 cm	BB-1206-09

### Iris Standard

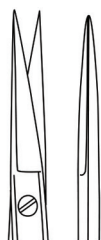

Length	Code
09 cm	BB-0125-09
10 cm	BB-0125-10
11 cm	BB-0125-11
12 cm	BB-0125-12



Length	Code
09 cm	BB-0126-09
10 cm	BB-0126-10
11 cm	BB-0126-11
12 cm	BB-0126-12

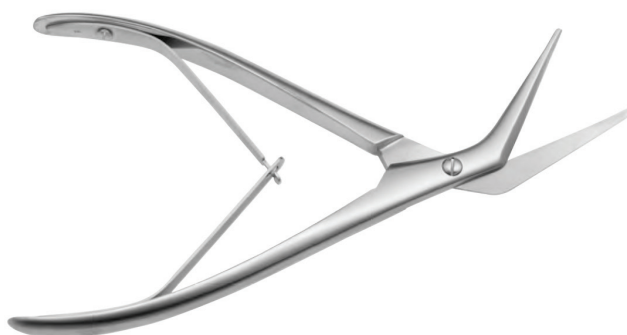

Delicate Surgical Scissors



SCISSORS

Iris-Fino

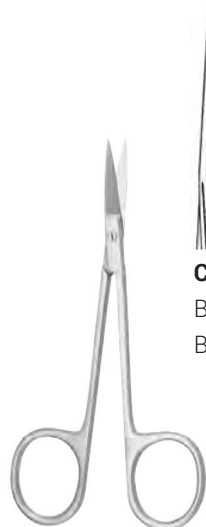

**Code**  
BB-0127-10  
BB-0127-11

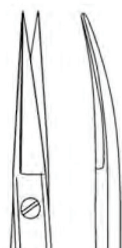

**Code**  
BB-0128-10  
BB-0128-11

Length	Code
10 cm	BB-0127-10 - BB-0128-10
11 cm	BB-0127-11 - BB-0128-11

Iris-Anatomy



**Code**  
BB-0129-11



**Code**  
BB-0130-11

Length	Code
11 cm	BB-0129-11 - BB-0130-11

Bonn



**Code**  
BB-0131-08  
BB-0131-09



**Code**  
BB-0132-08  
BB-0132-09

Length	Code
08 cm	BB-0131-08 - BB-0132-08
09 cm	BB-0131-09 - BB-0132-09

Graefe



Length	Code
10 cm	BB-0133-10

**Ribbon-Stevens Tenotomy**



**Code**  
BB-0164-10



**Code**  
BB-0165-10

Length	Code
10 cm	BB-0164-10 - BB-0165-10

**Ribbon-Iris**

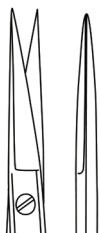

**Code**  
BB-0141-10



**Code**  
BB-0142-10

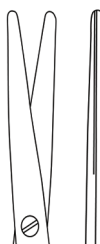

**Code**  
BB-0143-10



**Code**  
BB-0144-10

Length	Code
10 cm	BB-0141-10 - BB-0142-10 - BB-0143-10 - BB-0144-10

**Jabaley**



**Code**  
BB-0145-13



**Code**  
BB-0146-13

Length	Code
13 cm	BB-0145-13 - BB-0146-13

Vascular Scissors



SCISSORS

Satinsky



<b>Length</b>	<b>Code</b>
24 cm	BB-0306-24

Bozemann



<b>Length</b>	<b>Code</b>
23 cm	BB-0307-23

Klinkenbergh-Loth

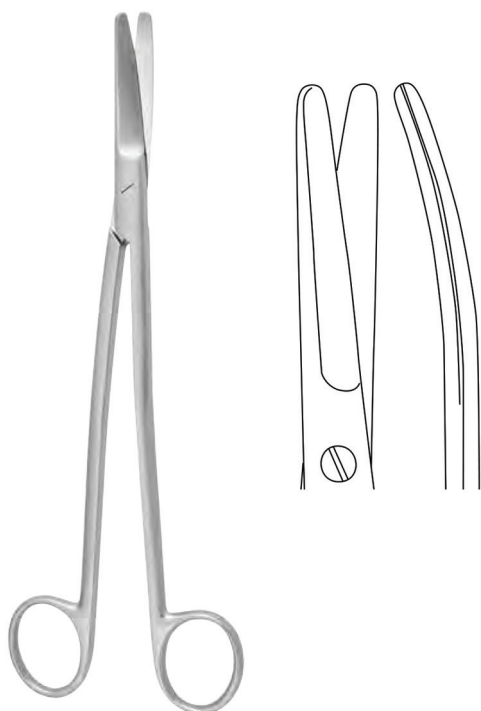

<b>Length</b>	<b>Code</b>
23 cm	BB-0308-23

Strully

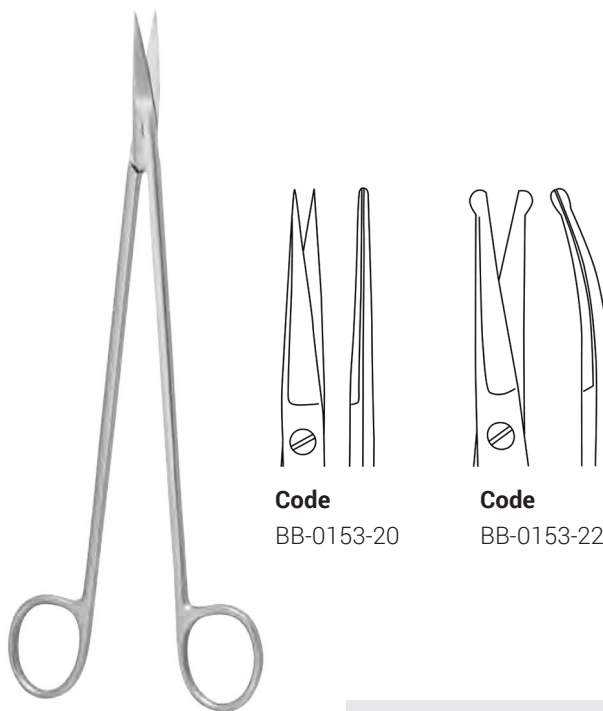

<b>Code</b>
BB-0153-20

<b>Code</b>
BB-0153-22

<b>Length</b>	<b>Code</b>
20 cm	BB-0153-20
22 cm	BB-0153-22



# SCISSORS

## Church

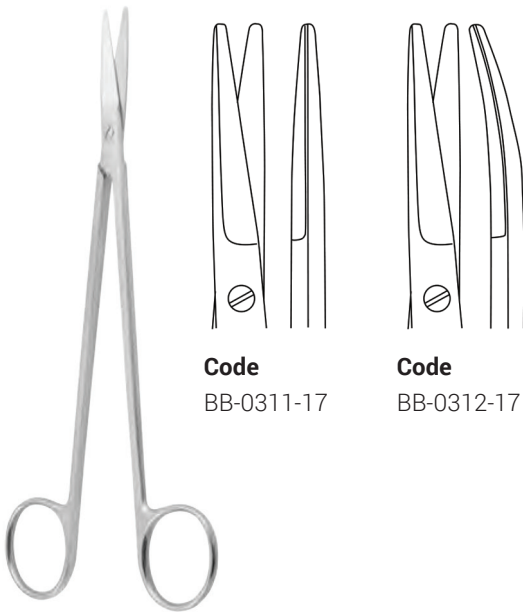

**Code**  
BB-0311-17

**Code**  
BB-0312-17

**Length**    **Code**  
17 cm      BB-0311-17 - BB-0312-17

## Jorgenson

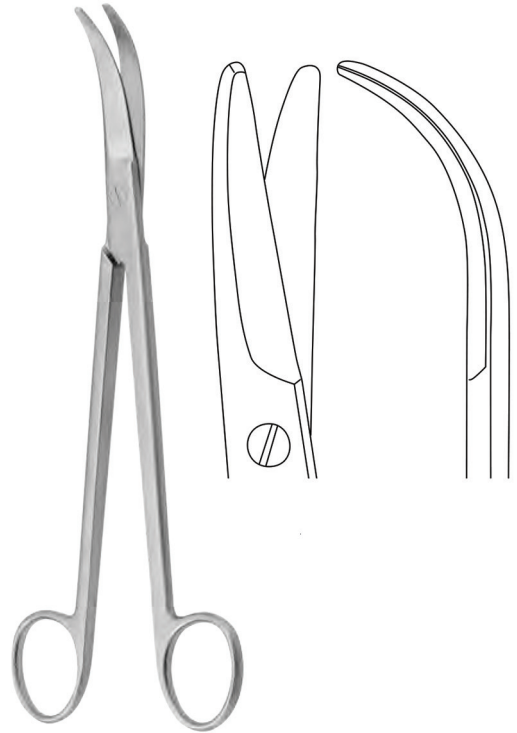

**Length**    **Code**  
23 cm      BB-0313-23

## Dandy

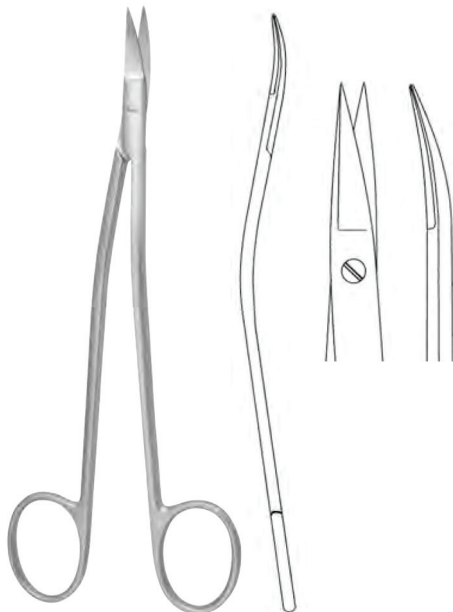

**Length**    **Code**  
17 cm      BB-0297-17

## Classon



**Length**    **Code**  
17 cm      BB-0295-17



# SCISSORS

## Potts-Smith

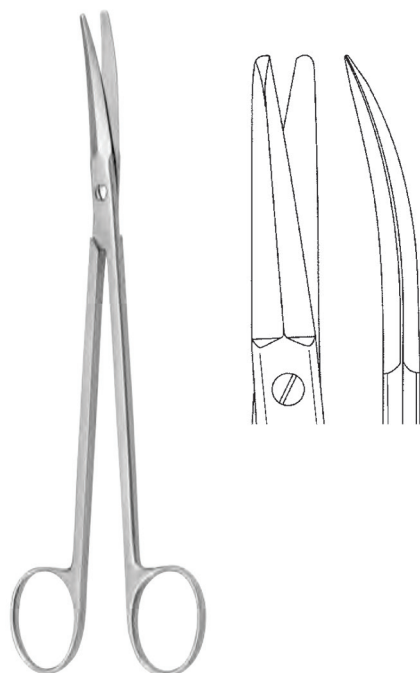

Length	Code
19 cm	BB-0293-19

## Locklin

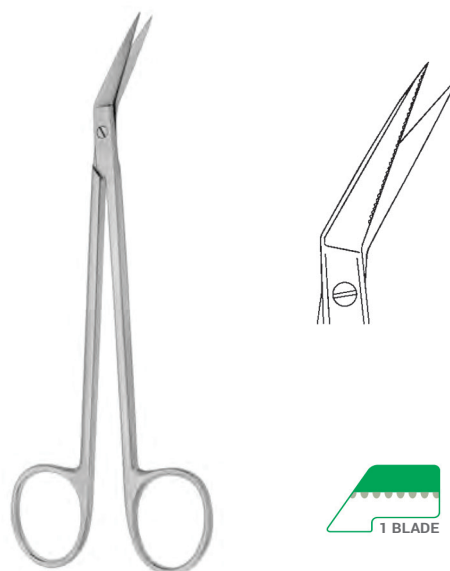

Length	Code
16 cm	BB-0534-16

## Locklin

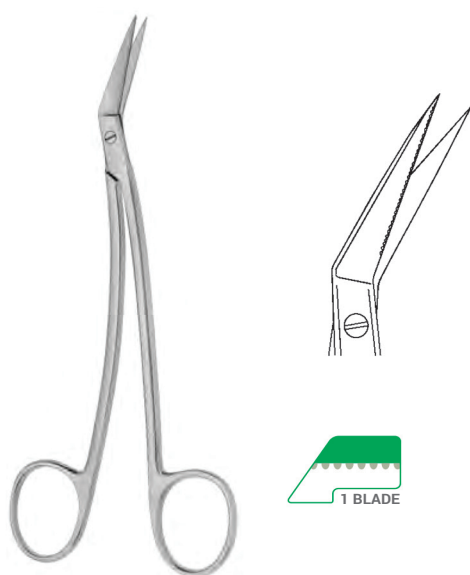

Length	Code
16 cm	BB-0536-16

## Schmieden-Taylor

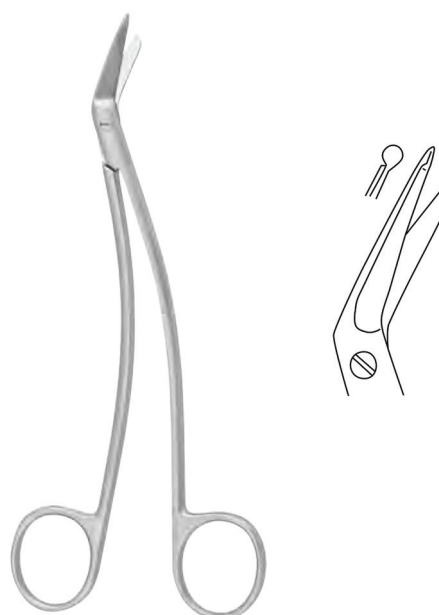

Length	Code
14 cm	BB-0290-14
17 cm	BB-0290-17



# SCISSORS

## DeBakey

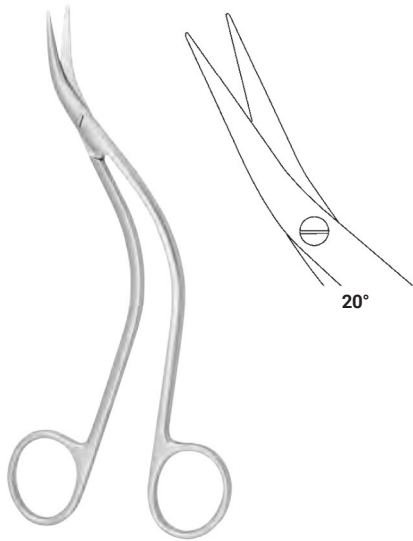

Length	Code
15 cm	BB-0996-15

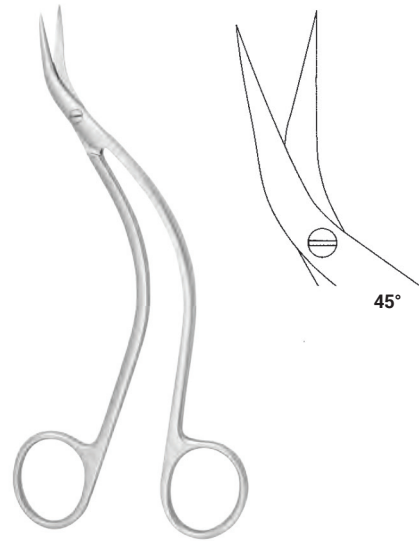

Length	Code
16 cm	BB-0998-16

## DeBakey

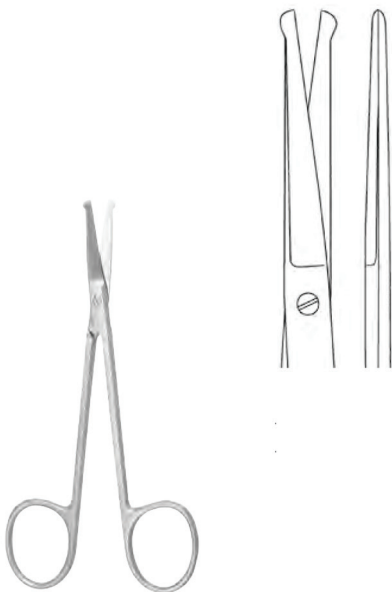

Length	Code
10 cm	BB-0001-10
11 cm	BB-0001-11

## Favaloro

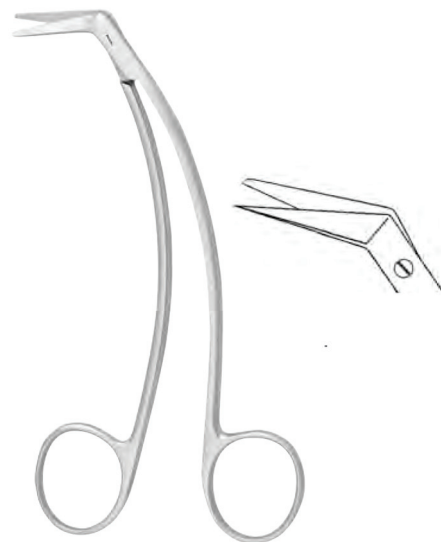

Length	Code
15 cm	BB-0002-15



Favaloro

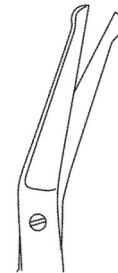

**Length**    **Code**  
11 cm      BB-0003-11

**Length**    **Code**  
11 cm      BB-0004-11

Favaloro



**Length**    **Code**  
14 cm      BB-0004-14

DeBakey

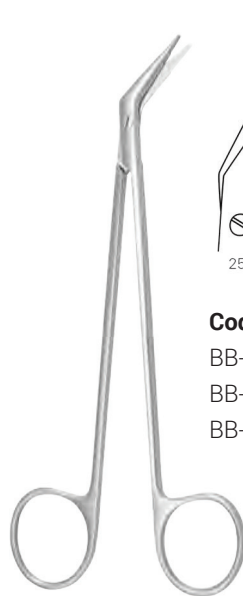

**Code**  
BB-0410-16  
BB-0410-19  
BB-0410-23

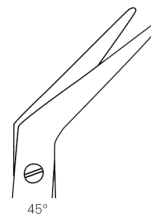

**Code**  
BB-0420-16  
BB-0420-19  
BB-0420-23

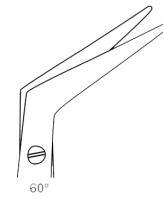

**Code**  
BB-11-0430-16  
BB-11-0430-19  
BB-11-0430-23

**Length**    **Code**  
16 cm      BB-0410-16 - BB-0420-16 - BB-11-0430-16  
19 cm      BB-0410-19 - BB-0420-19 - BB-11-0430-19  
23 cm      BB-0410-23 - BB-0420-23 - BB-11-0430-23

# SCISSORS

## Potts-Smith



**Code**  
BB-0154-19

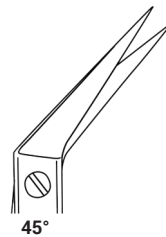

**Code**  
BB-0155-19

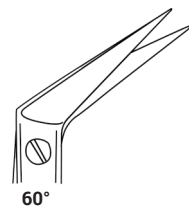

**Code**  
BB-0156-19



**Code**  
BB-0154-19B

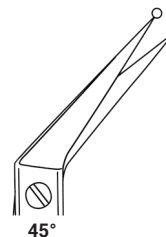

**Code**  
BB-0155-19B

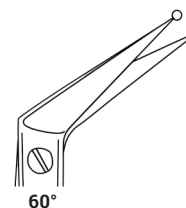

**Code**  
BB-0156-19B

Length	Code
18 cm	BB-0154-19 - BB-0155-19 - BB-0156-19 - BB-0154-19B - BB-0155-19B - BB-0156-19B

## Potts-Smith

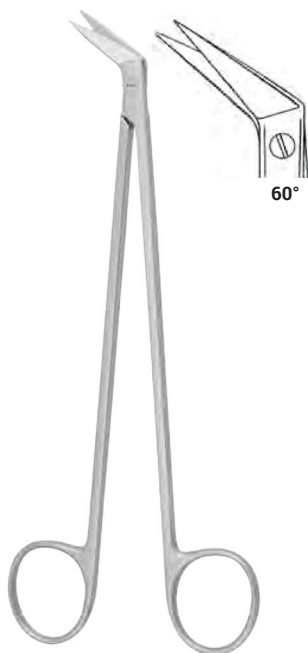

60°

Length	Code
18 cm	BB-0158-18

## Potts-De Martel

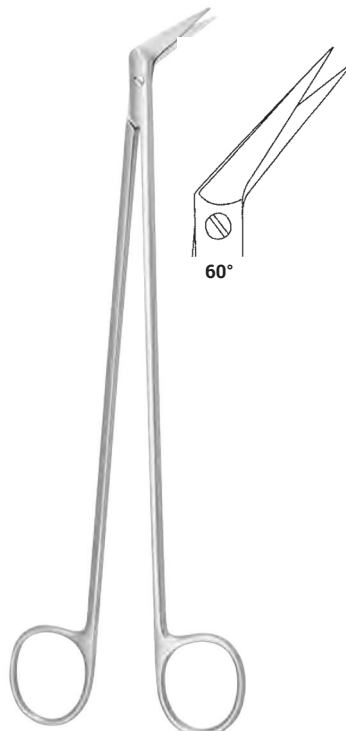

60°

Length	Code
22 cm	BB-0159-22

## Potts-Smith

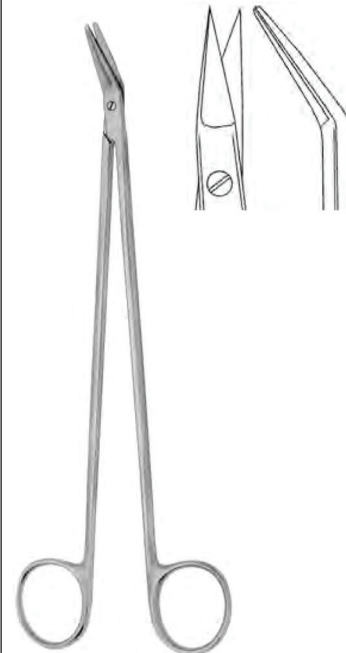

Length	Code
18 cm	BB-0160-18

Vascular Scissors 

SCISSORS

Mills

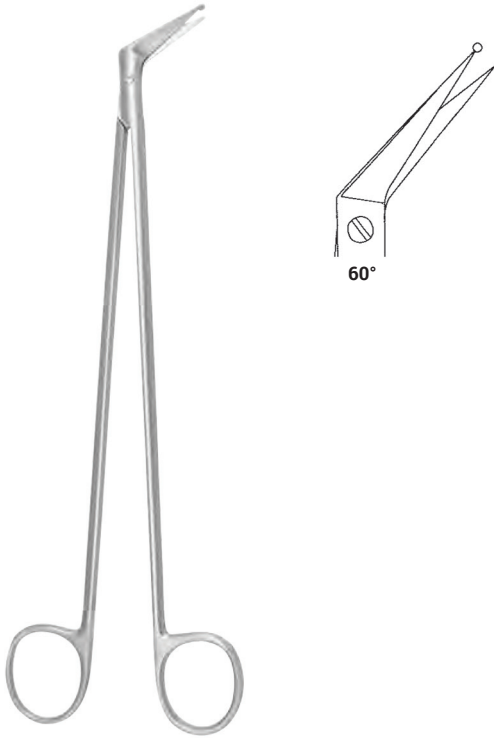

**Length** 22 cm  
**Code** BB-0161-22

Dietrich-Hegemann



**Length** 19 cm  
**Code** BB-0162-19

Dietrich-Hegemann available in petite point paediatric blades

Dietrich-Hegemann

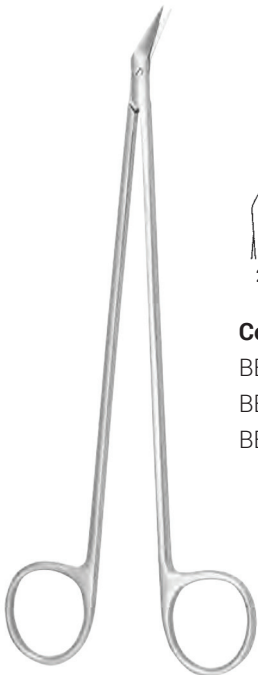

**Code**  
BB-0400-13  
BB-0400-16  
BB-0400-19

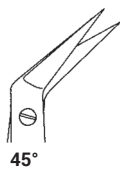

**Code**  
BB-0401-13  
BB-0401-16  
BB-0401-19

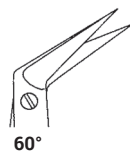

**Code**  
BB-0402-13  
BB-0402-16  
BB-0402-19

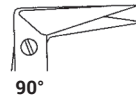

**Code**  
BB-0403-13  
BB-0403-16  
BB-0403-19

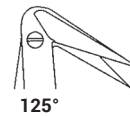

**Code**  
BB-0404-13  
BB-0404-16  
BB-0404-19

Dietrich-Hegemann available in petite point paediatric blades

**Length** 13 cm BB-0400-13 - BB-0401-13 - BB-0402-13 - BB-0403-13 - BB-0404-13  
16 cm BB-0400-16 - BB-0401-16 - BB-0402-16 - BB-0403-16 - BB-0404-16  
19 cm BB-0400-19 - BB-0401-19 - BB-0402-19 - BB-0403-19 - BB-0404-19



# SCISSORS

**Spencer-Fino**



Length	Code
11 cm	BB-0276-11

**Spencer**



Length	Code
09 cm	BB-0278-09
11 cm	BB-0278-11
13 cm	BB-0278-13



Length	Code
11 cm	BB-0281-11

**Shortbrent**



Length	Code
09 cm	BB-0279-09

**Locklin**



Length	Code
15 cm	BB-0532-15

**Northbent**



Length	Code
13 cm	BB-0276-13

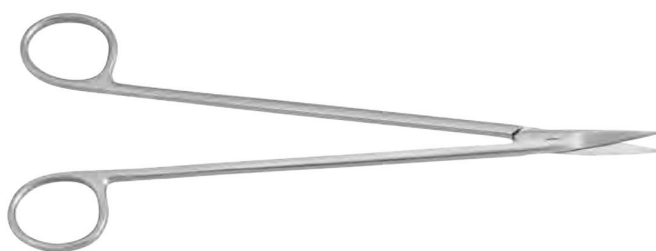

Ligature Scissors



SCISSORS

Littauer



Length	Code
14 cm	BB-0285-14

Littler

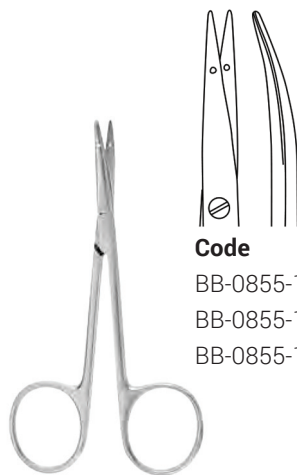

**Code**  
 BB-0855-11  
 BB-0855-14  
 BB-0855-18

Length	Code
11 cm	BB-0855-11
14 cm	BB-0855-14
18 cm	BB-0855-18

Buck

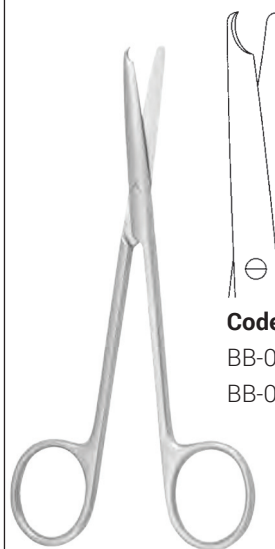

**Code**  
 BB-0282-14  
 BB-0282-18

Length	Code
14 cm	BB-0282-14
18 cm	BB-0282-18

Eiselsberg



Length	Code
12 cm	BB-0286-12

Heath

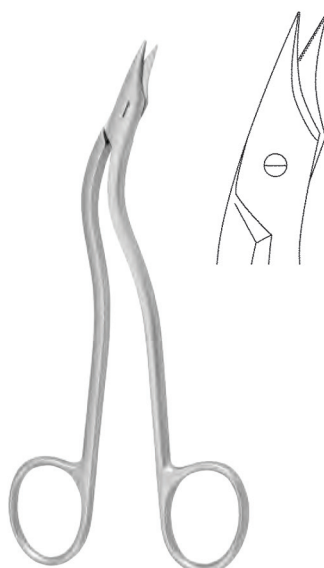

Length	Code
15 cm	BB-0287-15

Schoemaker-Loth



Length	Code
12 cm	BB-0288-12



**Beebee**

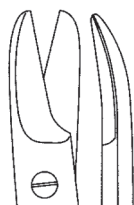

**Code**  
BB-0701-10



**Code**  
BB-0702-10

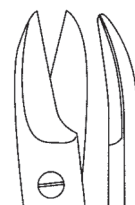

**Code**  
BB-0703-10

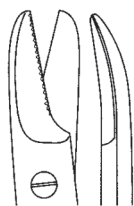

**Code**  
BB-0704-12

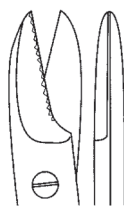

**Code**  
BB-0705-12

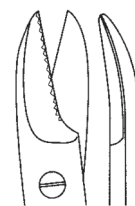

**Code**  
BB-0706-12



Length	Code
10 cm	BB-0701-10 - BB-0702-10 - BB-0703-10
12 cm	BB-0704-12 - BB-0705-12 - BB-0706-12

**Guilford-Wright**



Length	Code
12 cm	BB-0545-12

**Universal**



Length	Code
12 cm	BB-0546-12

**Harvey**

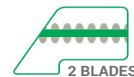
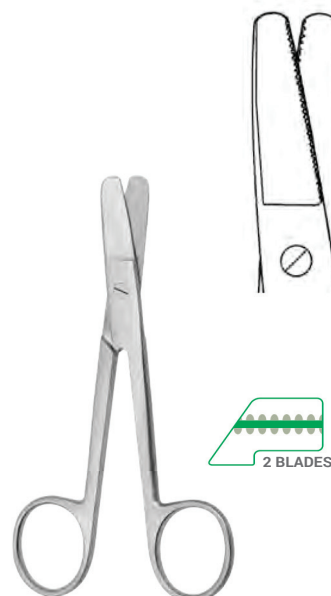

Length	Code
12 cm	BB-0547-12

## Supercut Scissors

- SUPERCUT Scissors have one razor blade which allows an easy and clean cut.
- The micro serration at the opposite blade prevents sliding off the tissue.

Characteristic: Golden Screw



Cutting Geometry

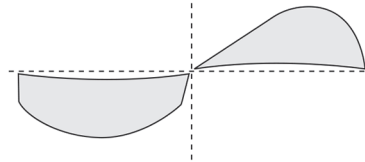



# SCISSORS

## Standard

### Fig. 2

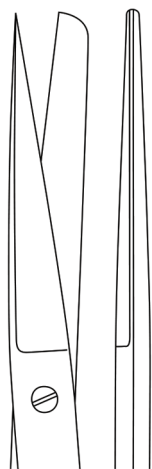

Surgical Scissors

Length	Code
13 cm	BB-3608-13
14 cm	BB-3608-14



### Fig. 2



Surgical Scissors

Length	Code
13 cm	BB-3609-13
14 cm	BB-3609-14



## Sims



Uterine Scissors

Length	Code
20 cm	BB-3500-20 - BB-3509-20
23 cm	BB-3500-23 - BB-3509-23

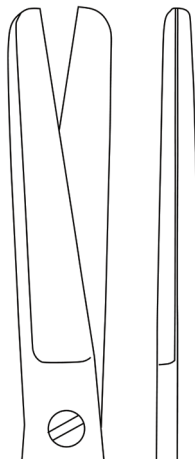

Code
BB-3500-20
BB-3500-23



Code
BB-3509-20
BB-3509-23





# SCISSORS

## Sims-Siebold-S

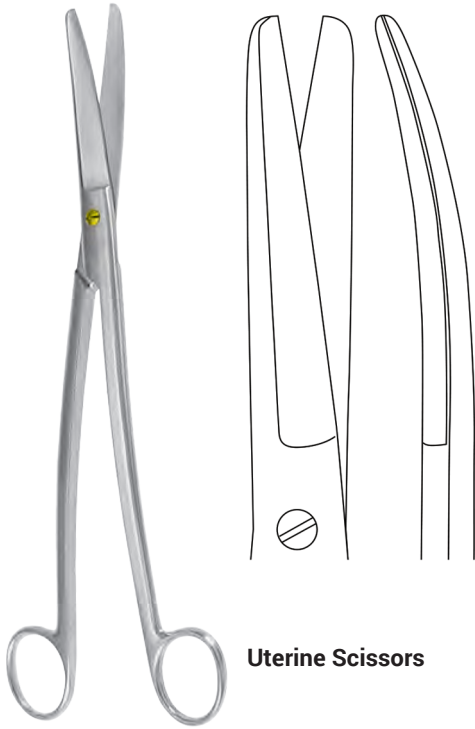

Uterine Scissors

**Length** 24 cm  
**Code** BB-3990-24



## Waldmann

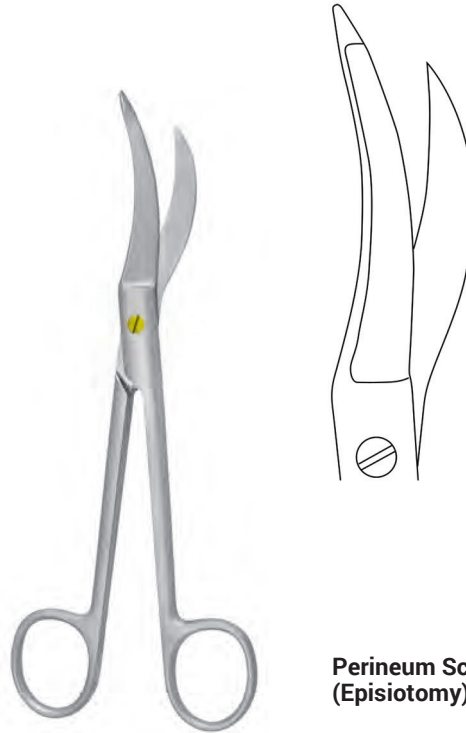

Perineum Scissors (Episiotomy)

**Length** 18 cm  
**Code** BB-3396-18



## Mayo

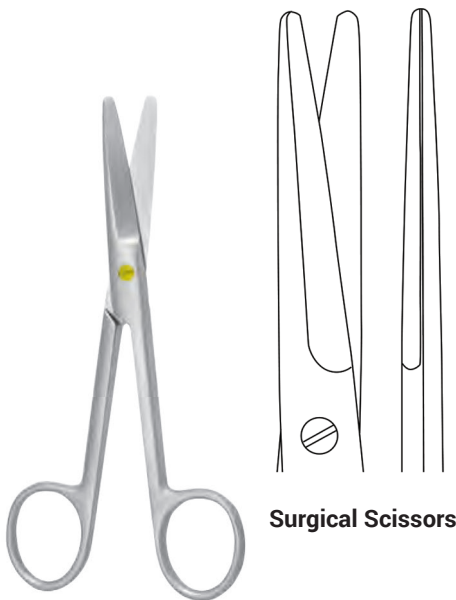

Surgical Scissors

**Length** 14 cm  
15 cm  
17 cm  
23 cm  
**Code** BB-3266-14  
BB-3266-15  
BB-3266-17  
BB-3266-23



Surgical Scissors

**Length** 14 cm  
15 cm  
17 cm  
23 cm  
**Code** BB-3269-14  
BB-3269-15  
BB-3269-17  
BB-3269-23





# SCISSORS

## Mayo-Harrington

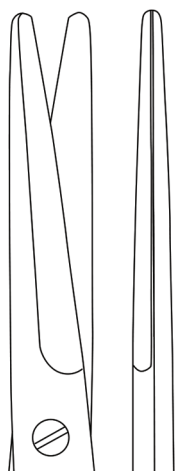

**Code**  
BB-3371-22



**Code**  
BB-3373-22

Surgical Scissors



Surgical Scissors

Length	Code
22 cm	BB-3371-22 - BB-3373-22

## Mayo-Stille

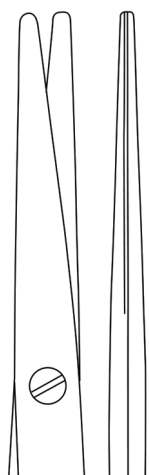

Surgical Scissors



Surgical Scissors

Length	Code
15 cm	BB-3360-15
17 cm	BB-3360-17



Length	Code
15 cm	BB-3361-15
17 cm	BB-3361-17





Metzenbaum

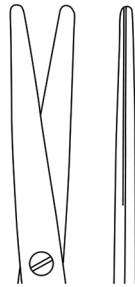

Dissecting Scissors



Length	Code
14 cm	BB-3200-14
18 cm	BB-3200-18
20 cm	BB-3200-20
23 cm	BB-3200-23
25 cm	BB-3200-25
30 cm	BB-3200-30

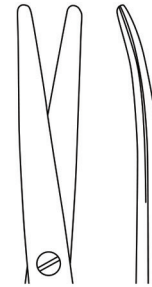

Dissecting Scissors



Length	Code
14 cm	BB-3201-14
18 cm	BB-3201-18
20 cm	BB-3201-20
23 cm	BB-3201-23
25 cm	BB-3201-25
30 cm	BB-3201-30

Metzenbaum-Fino

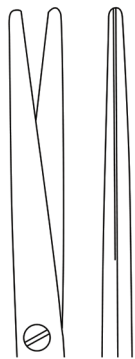

Dissecting Scissors



Length	Code
12 cm	BB-3197-12
14 cm	BB-3197-14
18 cm	BB-3197-18
20 cm	BB-3197-20
23 cm	BB-3197-23

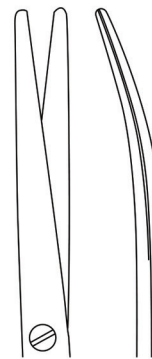

Dissecting Scissors



Length	Code
12 cm	BB-3198-12
14 cm	BB-3198-14
18 cm	BB-3198-18
20 cm	BB-3198-20
23 cm	BB-3198-23

# SCISSORS

## Metzenbaum-Baby

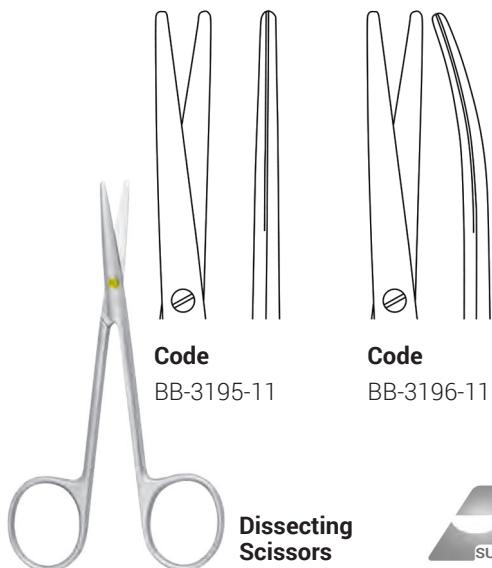

**Code**  
BB-3195-11

**Code**  
BB-3196-11

**Dissecting Scissors**



**Length**    **Code**  
11 cm        BB-3195-11 - BB-3196-11

## Lexer

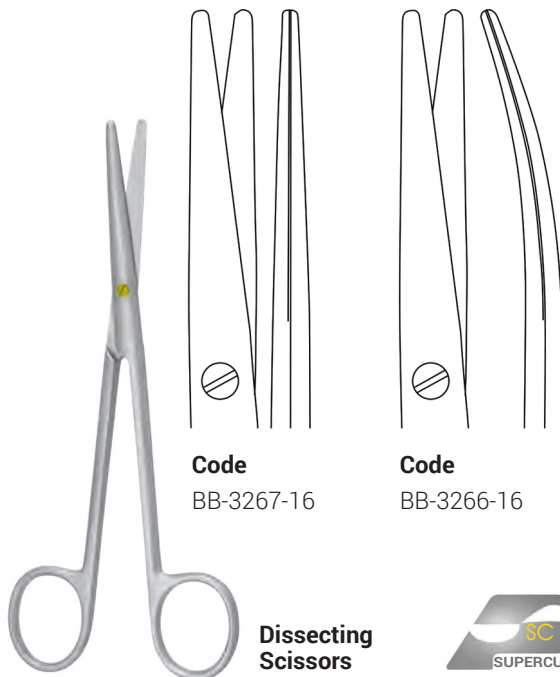

**Code**  
BB-3267-16

**Code**  
BB-3266-16

**Dissecting Scissors**



**Length**    **Code**  
16 cm        BB-3267-16 - BB-3266-16

## Kilner (Ragnell)

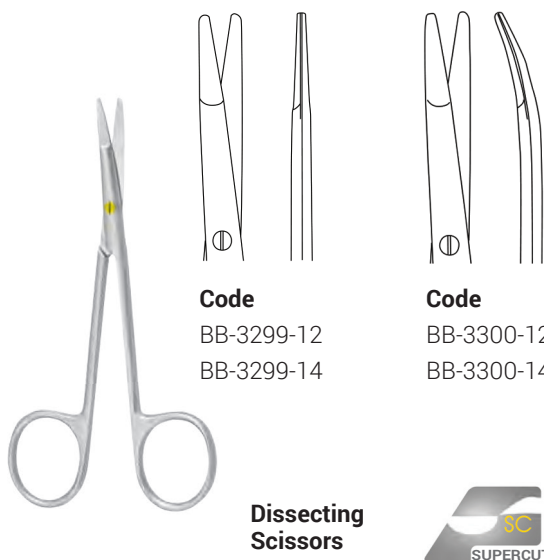

**Code**  
BB-3299-12  
BB-3299-14

**Code**  
BB-3300-12  
BB-3300-14

**Dissecting Scissors**



**Length**    **Code**  
12 cm        BB-3299-12 - BB-3300-12  
14 cm        BB-3299-14 - BB-3300-14

## Jameson

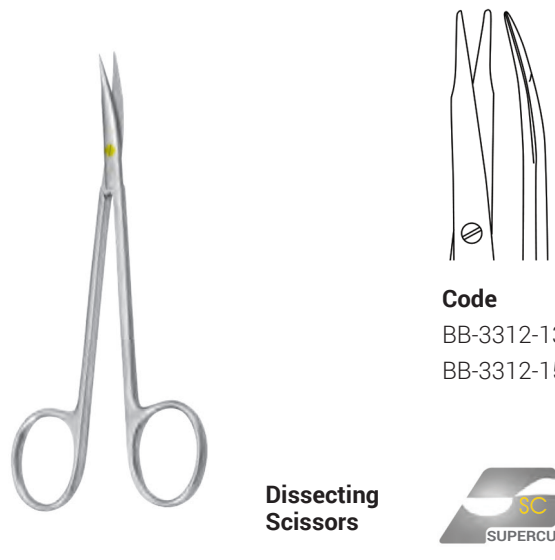

**Code**  
BB-3312-13  
BB-3312-15

**Dissecting Scissors**



**Length**    **Code**  
13 cm        BB-3312-13 - BB-3312-15

Supercut Scissors 

SCISSORS

Reynolds

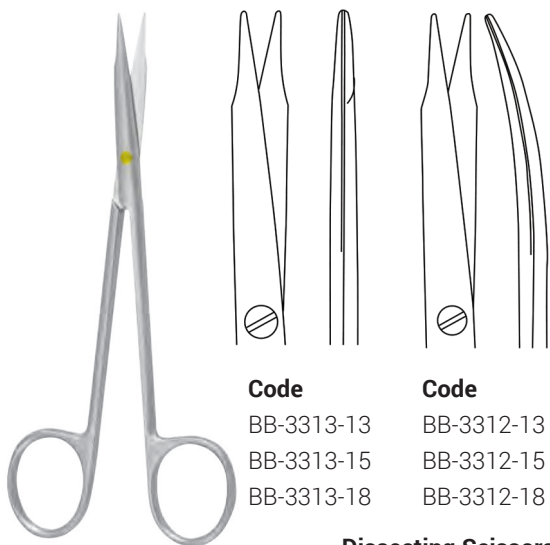

<b>Code</b>	<b>Code</b>
BB-3313-13	BB-3312-13
BB-3313-15	BB-3312-15
BB-3313-18	BB-3312-18

**Dissecting Scissors**

<b>Length</b>	<b>Code</b>
13 cm	BB-3313-13 - BB-3312-13
15 cm	BB-3313-15 - BB-3312-15
18 cm	BB-3313-18 - BB-3312-18



Heymann

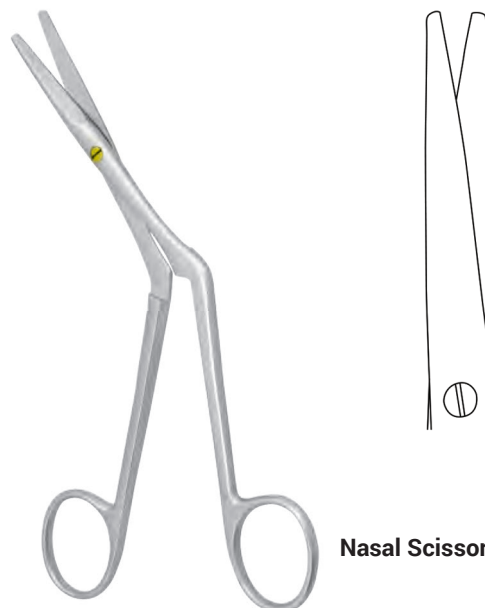

**Nasal Scissors**

<b>Length</b>	<b>Code</b>
18 cm	BB-3320-18



Kelly

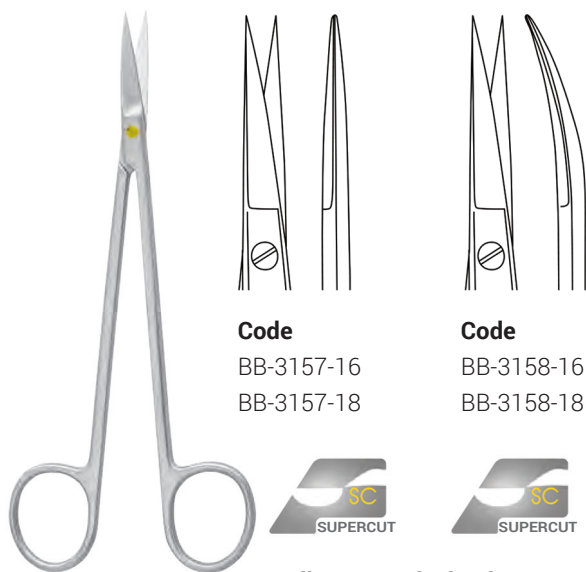

<b>Code</b>	<b>Code</b>
BB-3157-16	BB-3158-16
BB-3157-18	BB-3158-18

**Delicate Surgical Scissors**

<b>Length</b>	<b>Code</b>
16 cm	BB-3157-16 - BB-3158-16
18 cm	BB-3157-18 - BB-3158-18



Stevens Tenotomy

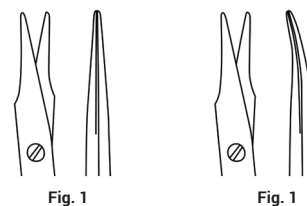

<b>Code</b>	<b>Code</b>
BB-3167-12	BB-3168-12
BB-3167-13	BB-3168-13
BB-3167-18	BB-3168-18

**Delicate Surgical Scissors**

<b>Length</b>	<b>Code</b>
12 cm	BB-3167-12 - BB-3168-12
13 cm	BB-3167-13 - BB-3168-13
18 cm	BB-3167-18 - BB-3168-18



# SCISSORS

## Iris

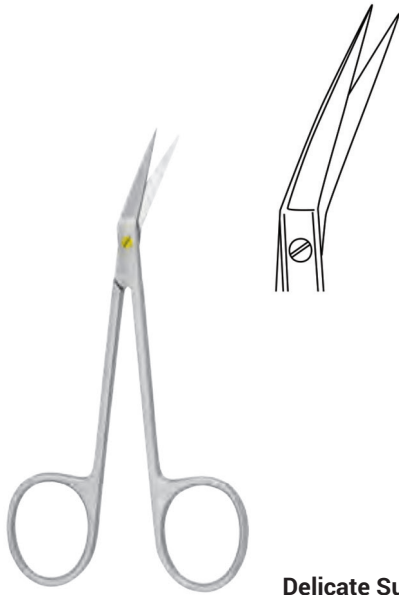

Delicate Surgical Scissors

Length	Code
11 cm	BB-3113-11



Delicate Surgical Scissors

Length	Code
09 cm	BB-3125-09
11 cm	BB-3125-11



## Iris

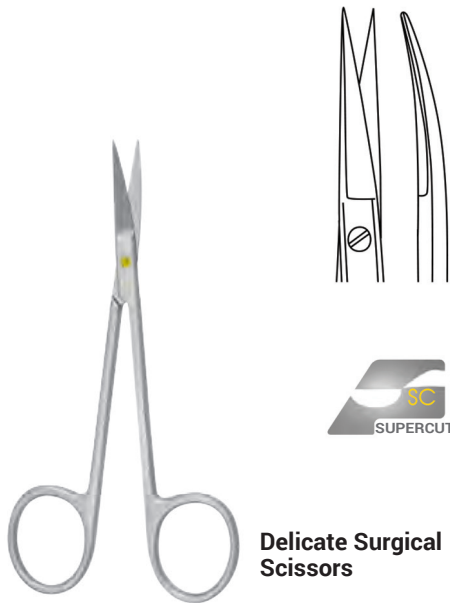

Delicate Surgical Scissors

Length	Code
09 cm	BB-3126-09
11 cm	BB-3126-11



## Jabaley

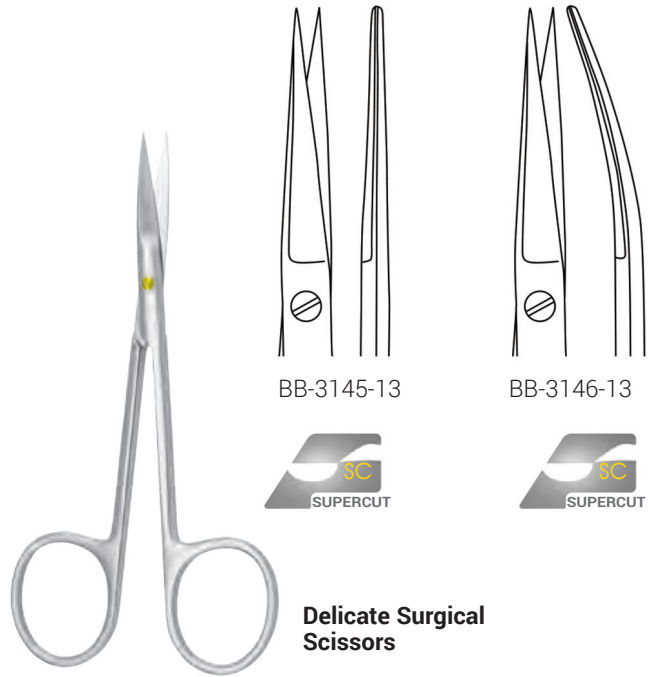

BB-3145-13

BB-3146-13



Delicate Surgical Scissors

Length	Code
13 cm	BB-3145-13 - BB-3146-13

**Potts-Smith**

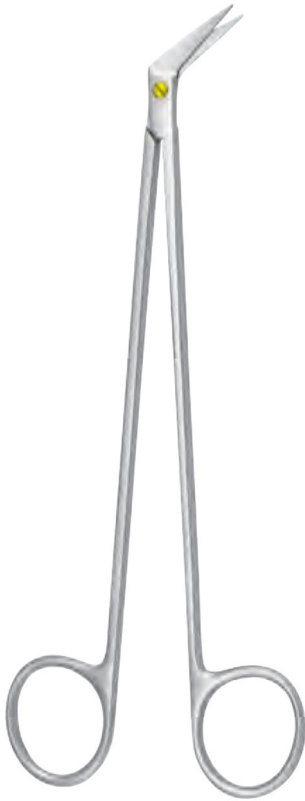

25°

**Code**

BB-0154-19

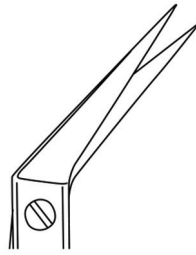

45°

**Code**

BB-0155-19

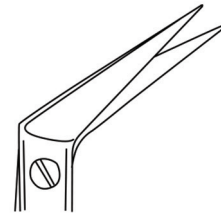

60°

**Code**

BB-0156-19



**Vascular Scissors**

**Length**

19 cm

**Code**

BB-0154-19 - BB-0155-19 - BB-0156-19

**Dietrich-Hegemann**

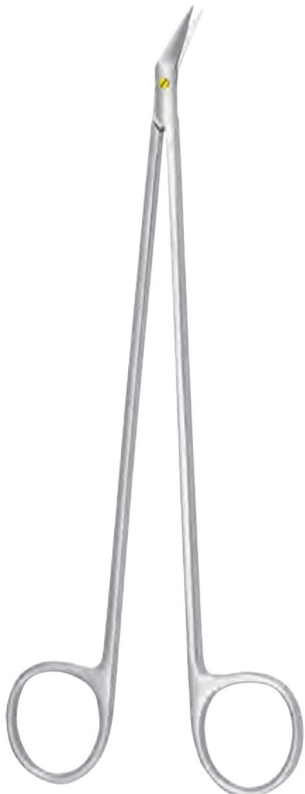

25°

**Code**

BB-3400-19

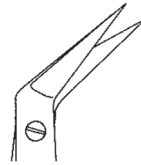

45°

**Code**

BB-3401-19

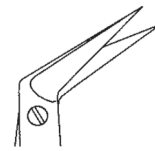

60°

**Code**

BB-3402-19

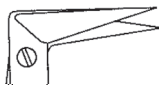

90°

**Code**

BB-3403-19

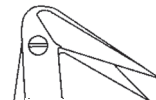

125°

**Code**

BB-3404-19



Dietrich-Hegemann available in petite point paediatric blades

**Vascular Scissors**

**Length**

19 cm

**Code**

BB-3400-19 - BB-3401-19 - BB-3402-19 - BB-3403-19 - BB-3404-19

## Scissors with Tungsten Carbide Edges

- Welded Tungsten Carbide Cutting Edges, therefore no seam tending to corrosion.
- Durable sharp cutting edge.
- Regular and smooth function.

Cutting Geometry

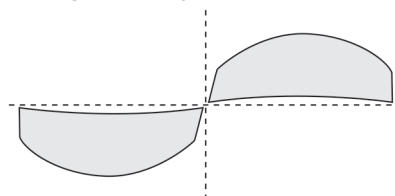

Characteristic: Golden Rings



1 Serrated Blade

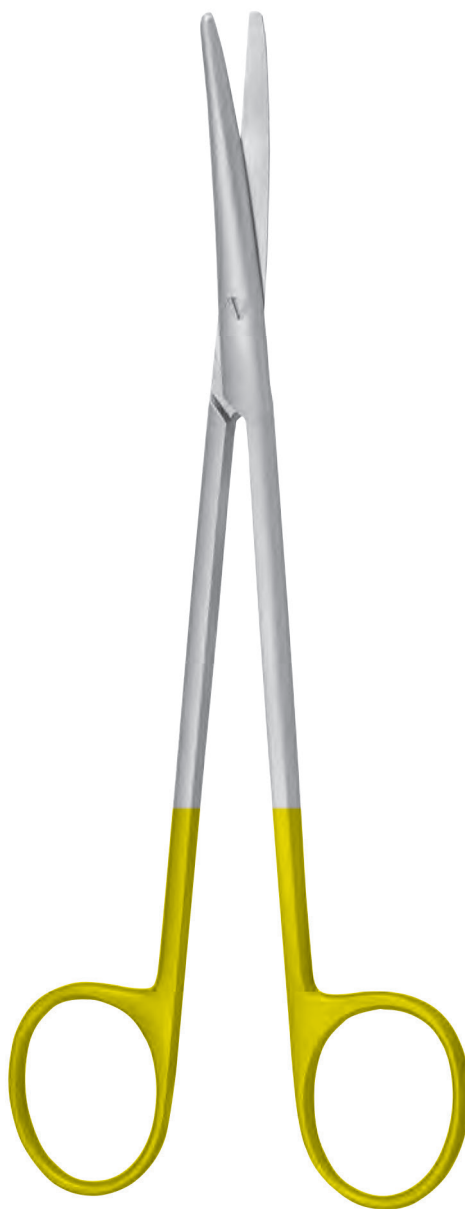



# SCISSORS

**Standard**

**Fig. 1**

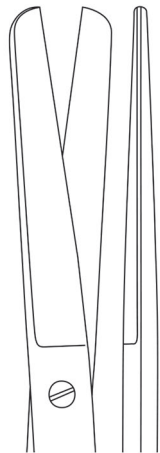

Length	Code
14 cm	BB-2606-14
16 cm	BB-2606-16
18 cm	BB-2606-18

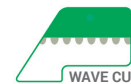

Length	Code
14 cm	BB-2607-14
16 cm	BB-2607-16
18 cm	BB-2607-18

**Standard**

**Fig. 2**

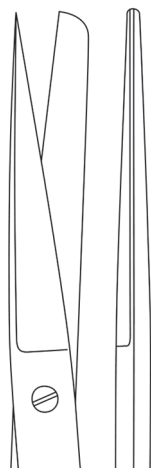
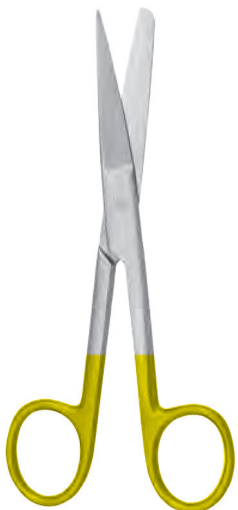

Length	Code
11 cm	BB-2608-11
14 cm	BB-2608-14
16 cm	BB-2608-16
18 cm	BB-2608-18

**Fig. 2**



Length	Code
14 cm	BB-2609-14
16 cm	BB-2609-16
18 cm	BB-2609-18



# SCISSORS

## Standard



## Fig. 3

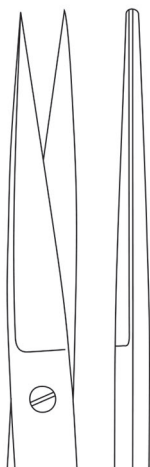

Length	Code
14 cm	BB-2610-14
16 cm	BB-2610-16
18 cm	BB-2610-18



Length	Code
14 cm	BB-2611-14
16 cm	BB-2611-16
18 cm	BB-2611-18

## Mixer

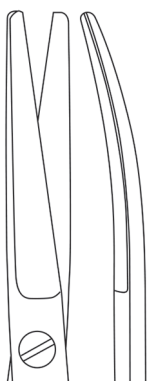

Length	Code
15 cm	BB-2444-15

## Waldmann

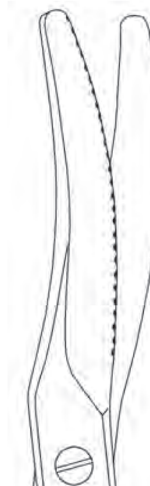

Length	Code
20 cm	BB-2396-20

Perineum Scissors (Episiotomy)

Sims

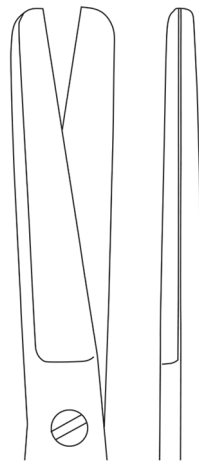

**Code**  
BB-2500-20  
BB-2500-23



**Code**  
BB-2509-20  
BB-2509-23



Length	Code
20 cm	BB-2500-20 - BB-2509-20
23 cm	BB-2500-23 - BB-2509-23

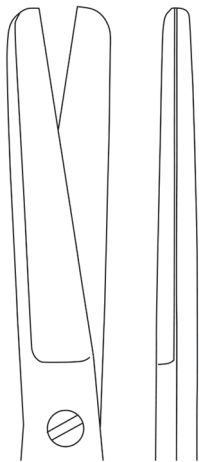

**Code**  
BB-2500-20W  
BB-2500-23W



**Code**  
BB-2509-20W  
BB-2509-23W



Length	Code
20 cm	BB-2500-20W - BB-2509-20W
23 cm	BB-2500-23W - BB-2509-23W

# SCISSORS

## Sims

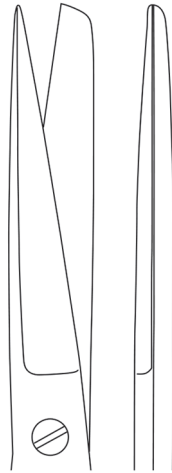

**Code**  
BB-2501-20  
BB-2501-23



**Code**  
BB-2502-20  
BB-2502-23



Length	Code
20 cm	BB-2501-20 - BB-2502-20
23 cm	BB-2501-23 - BB-2502-23



**Code**  
BB-2503-20  
BB-2503-23



**Code**  
BB-2504-20  
BB-2504-23



Length	Code
20 cm	BB-2503-20 - BB-2504-20
23 cm	BB-2503-23 - BB-2504-23



Mayo

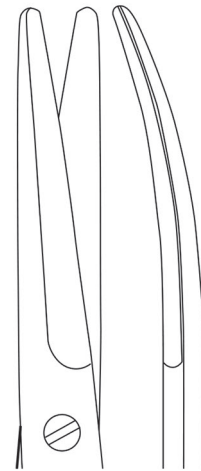
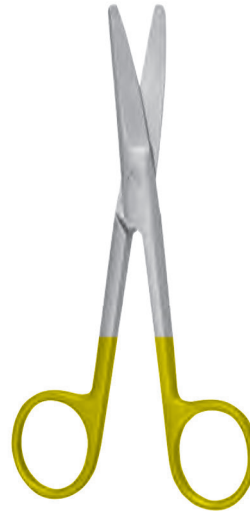
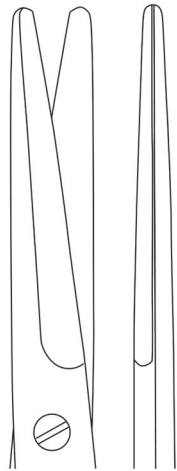

Length	Code
14 cm	BB-2366-14
17 cm	BB-2366-17
23 cm	BB-2366-23
25 cm	BB-2366-25



Length	Code
14 cm	BB-2369-14
17 cm	BB-2369-17
23 cm	BB-2369-23
36 cm	BB-2369-36
40 cm	BB-2369-40



Mayo



Length	Code
17 cm	BB-2369-17W

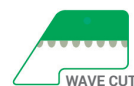

Mayo-Harrington

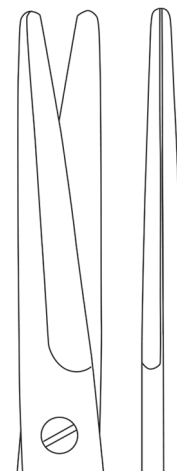

Length	Code
22 cm	BB-2366-22W





Mayo-Harrington

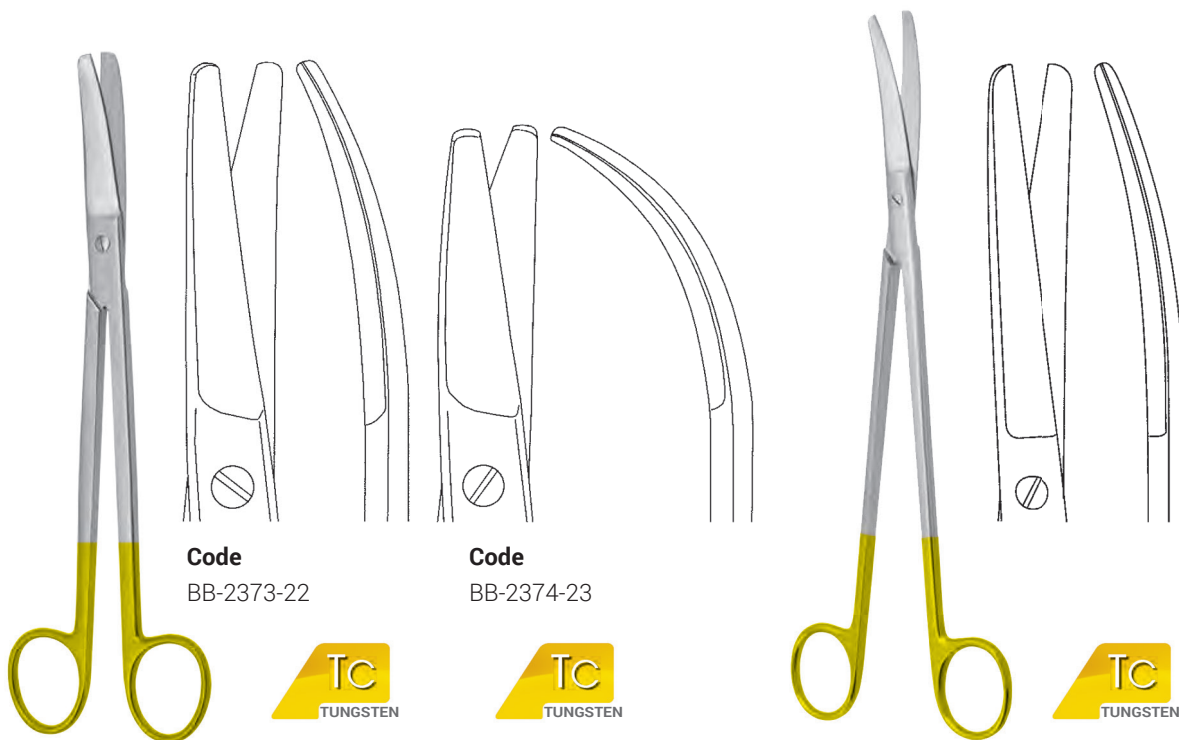

**Code**  
BB-2373-22

**Code**  
BB-2374-23

**Length**    **Code**  
23 cm        BB-2375-23

**Length**    **Code**  
22 cm        BB-2373-22  
23 cm        BB-2374-23

Mayo-Harrington



**Length**    **Code**  
25 cm        BB-2376-25

Wertheim



**Length**    **Code**  
25 cm        BB-2378-25



Mayo-Stille

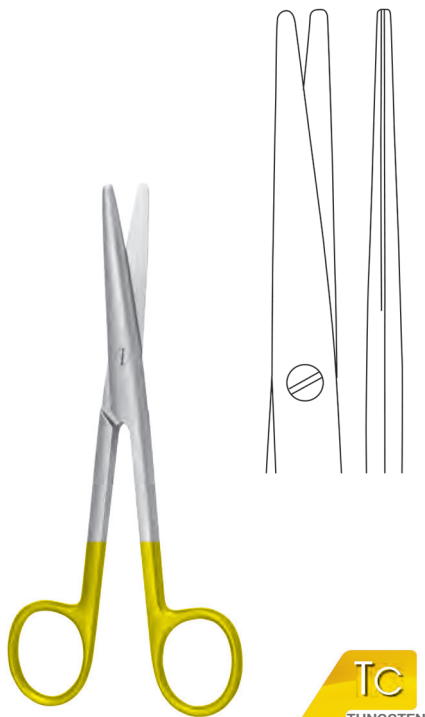

Length	Code
15 cm	BB-2360-15
17 cm	BB-2360-17
21 cm	BB-2360-21

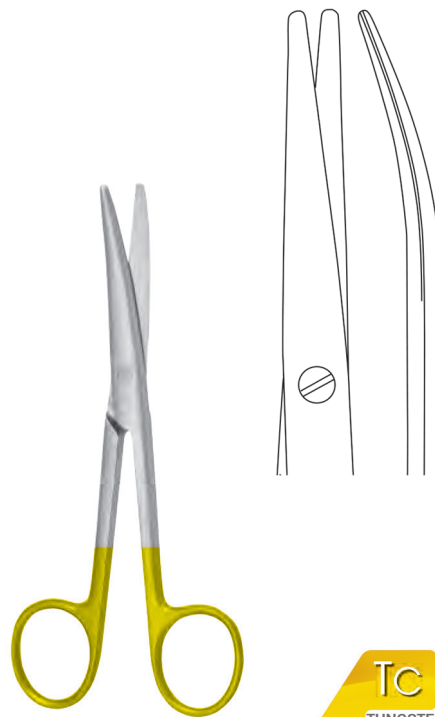

Length	Code
15 cm	BB-2361-15
17 cm	BB-2361-17
21 cm	BB-2361-21

Metzenbaum



Length	Code
11 cm	BB-2200-11
14 cm	BB-2200-14
18 cm	BB-2200-18
20 cm	BB-2200-20
22 cm	BB-2200-22
23 cm	BB-2200-23
25 cm	BB-2200-25
28 cm	BB-2200-28
30 cm	BB-2200-30



Length	Code
11 cm	BB-2201-11
14 cm	BB-2201-14
18 cm	BB-2201-18
20 cm	BB-2201-20
22 cm	BB-2201-22
23 cm	BB-2201-23
25 cm	BB-2201-25
28 cm	BB-2201-28
30 cm	BB-2201-30
36 cm	BB-2201-36
40 cm	BB-2201-40



# SCISSORS

## Metzenbaum

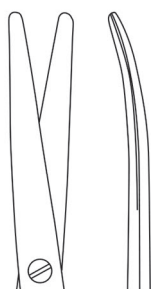
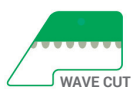
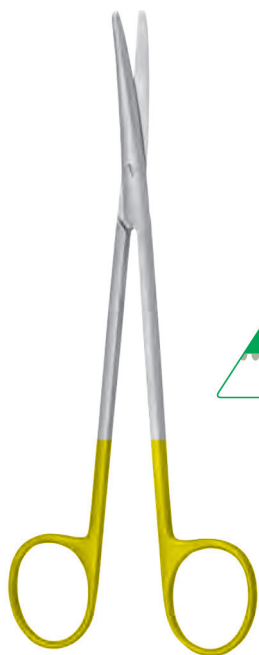

Length	Code
11 cm	BB-2201-11W
14 cm	BB-2201-14W
18 cm	BB-2201-18W
20 cm	BB-2201-20W
23 cm	BB-2201-23W

## Metzenbaum-S

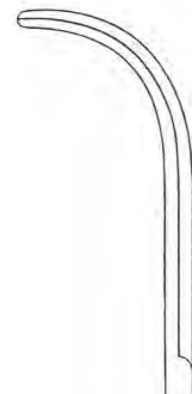

Length	Code
20 cm	BB-2232-20
23 cm	BB-2232-23
25 cm	BB-2232-25
28 cm	BB-2232-28

## Metzenbaum

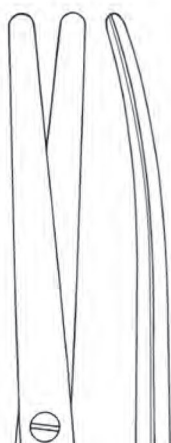

Length	Code
23 cm	BB-2207-23

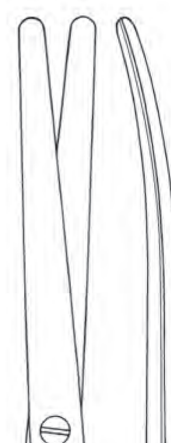
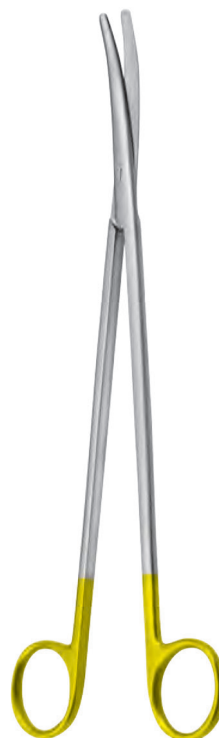

Length	Code
23 cm	BB-2208-23



Metzenbaum-Fino

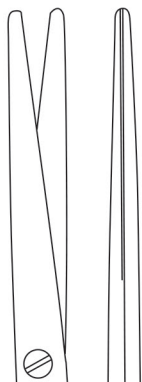
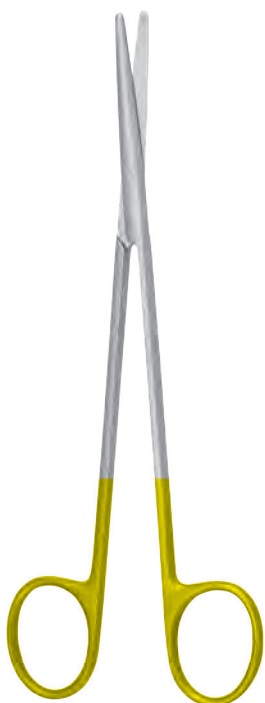

Length	Code
14 cm	BB-2197-14
18 cm	BB-2197-18
20 cm	BB-2197-20
23 cm	BB-2197-23
25 cm	BB-2197-25
28 cm	BB-2197-28

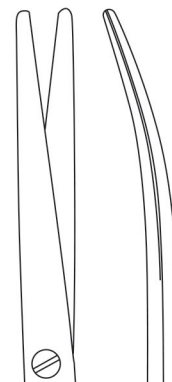

Length	Code
14 cm	BB-2198-14
18 cm	BB-2198-18
20 cm	BB-2198-20
23 cm	BB-2198-23
25 cm	BB-2198-25
28 cm	BB-2198-28

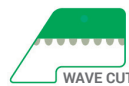

Length	Code
14 cm	BB-2198-14W
18 cm	BB-2198-18W
20 cm	BB-2198-20W
23 cm	BB-2198-23W
25 cm	BB-2198-25W
28 cm	BB-2198-28W



# SCISSORS

## Metzenbaum-Fino

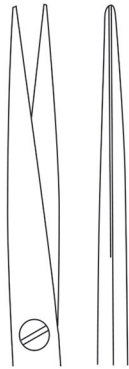

Length	Code
14 cm	BB-2239-14
18 cm	BB-2239-18
20 cm	BB-2239-20
23 cm	BB-2239-23



Length	Code
11 cm	BB-2240-11
14 cm	BB-2240-14
18 cm	BB-2240-18
20 cm	BB-2240-20
23 cm	BB-2240-23

## Metzenbaum-Fino-S

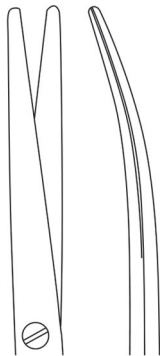
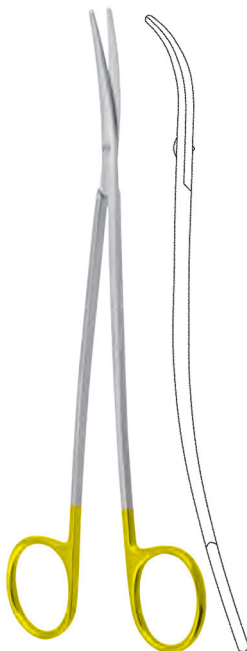

Length	Code
18 cm	BB-2172-18
20 cm	BB-2172-20
23 cm	BB-2172-23

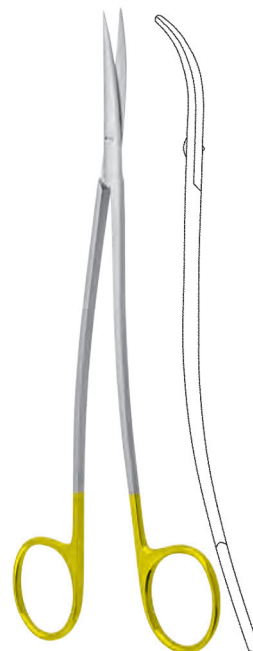

Length	Code
18 cm	BB-2173-18
20 cm	BB-2173-20
23 cm	BB-2173-23

Dissecting Scissors



SCISSORS

Mayo-Lexer

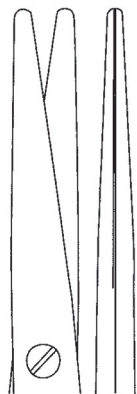

**Code**  
BB-2370-16  
BB-2370-21



**Code**  
BB-2371-16  
BB-2371-21



Length	Code
16 cm	BB-2370-16 - BB-2371-16
21 cm	BB-2370-21 - BB-2371-21

Lexer

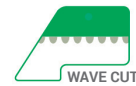
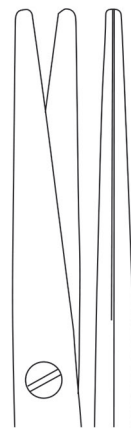
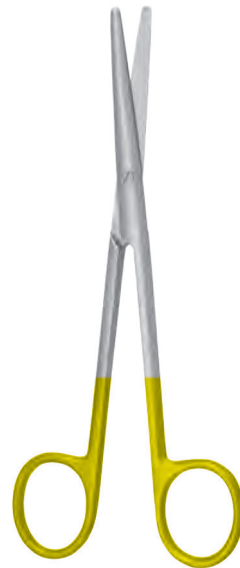

Length	Code
16 cm	BB-2267-16W

Lexer

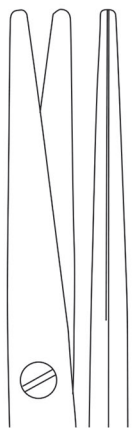
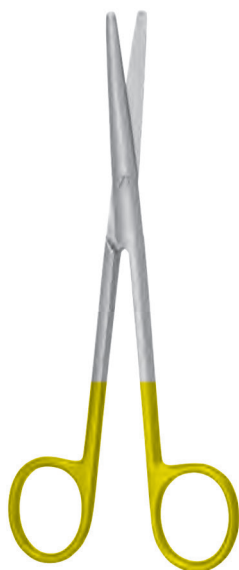

**Code**  
BB-2267-16

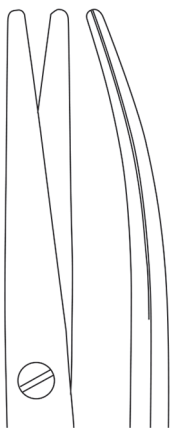

**Code**  
BB-2266-16



Length	Code
16 cm	BB-2267-16 - BB-2266-16

Thorek

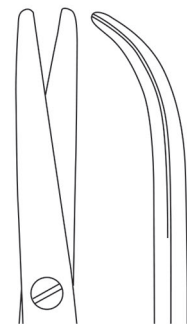

Length	Code
20 cm	BB-2304-20
23 cm	BB-2304-23
28 cm	BB-2304-28

# SCISSORS

## Dissecting Scissors

### Joseph



Length	Code
14 cm	BB-2151-14
17 cm	BB-2151-17

### Kilner

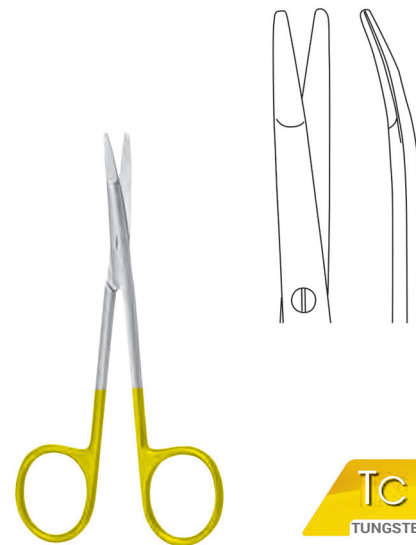

Length	Code
12 cm	BB-2299-12
14 cm	BB-2299-14

### Jameson



Length	Code
13 cm	BB-2312-13
15 cm	BB-0312-15

### Reynolds

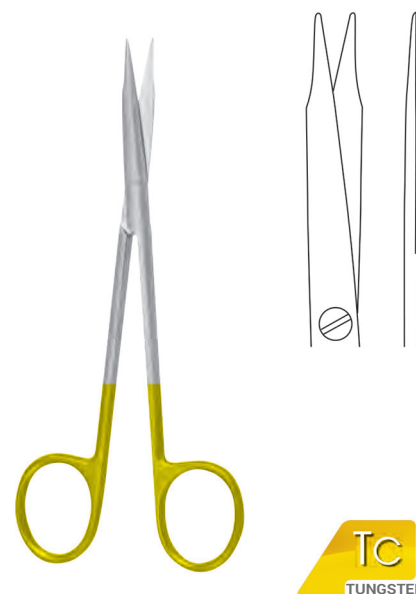

Length	Code
15 cm	BB-2313-15



Reynolds

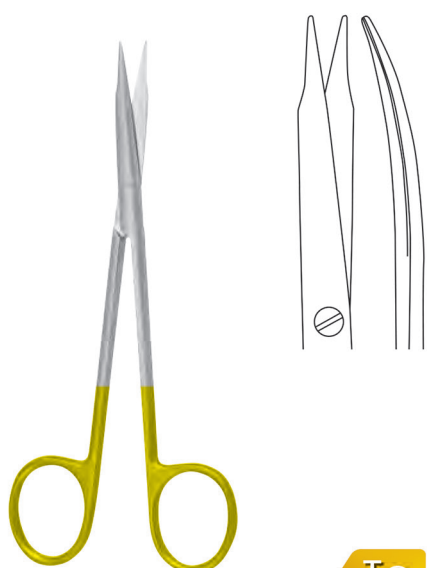

Length	Code
15 cm	BB-2312-15
18 cm	BB-2312-18

Metzenbaum-Lahey

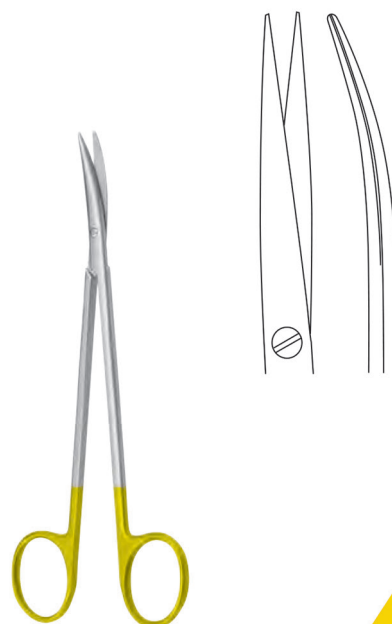

Length	Code
14 cm	BB-2238-14

Metzenbaum-Lahey

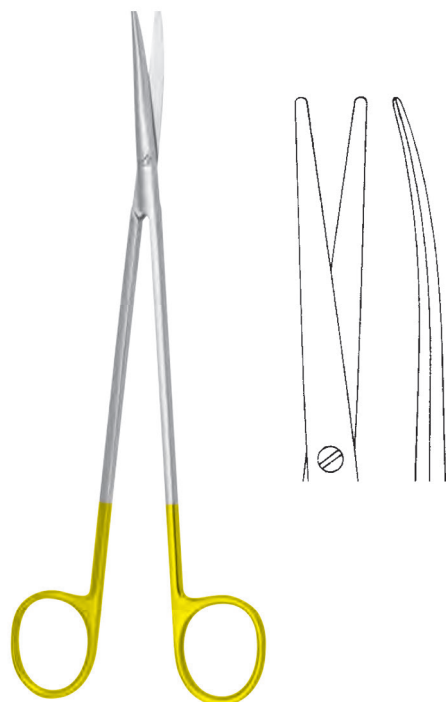

Length	Code
20 cm	BB-2238-20
23 cm	BB-2238-23

Toennis-Adson

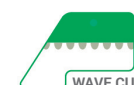

Length	Code
17 cm	BB-2295-17

Length	Code
17 cm	BB-2295-17W

# SCISSORS

Tonsil Scissors, Nasal Scissors



## Dean

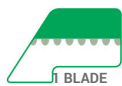
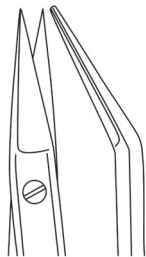
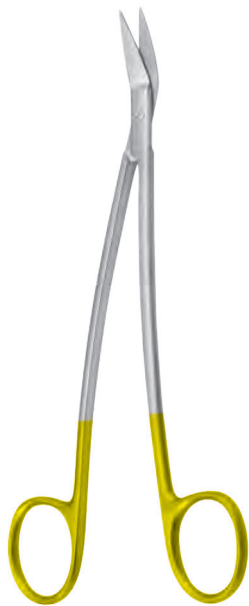

Tonsil Scissors

**Length** 17 cm  
**Code** BB-2250-17

## Fomon



Nasal Scissors

**Length** 13 cm  
**Code** BB-2046-13

## Fomon



Nasal Scissors

**Length** 13 cm  
**Code** BB-2236-13

## Cottle

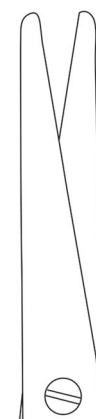

Nasal Scissors

**Length** 16 cm  
**Code** BB-2328-16

Face-lift Scissors



SCISSORS

Gorney

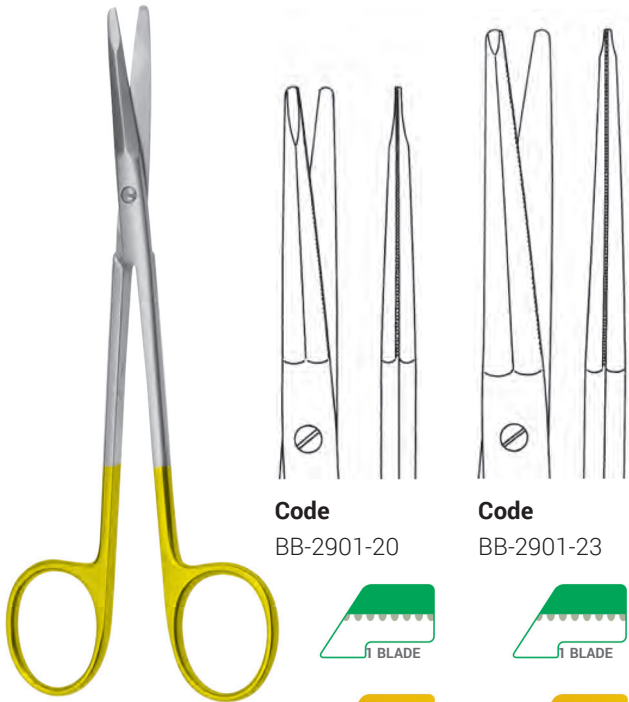

**Code**  
BB-2901-20

**Code**  
BB-2901-23

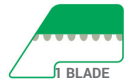

Length	Code
20 cm	BB-2901-20
23 cm	BB-2901-23

Fomon

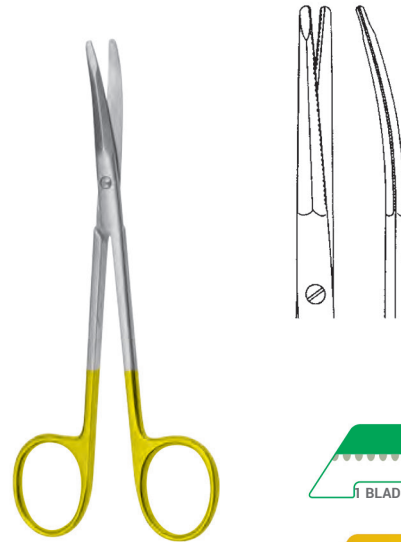

Length	Code
14 cm	BB-2327-14



Kaye

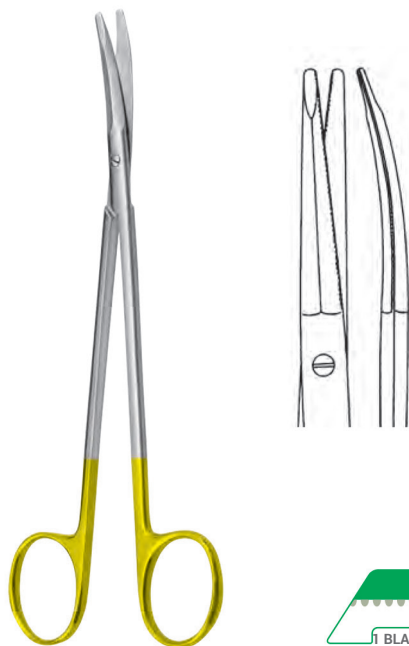

Length	Code
15 cm	BB-2866-15
18 cm	BB-2866-18



Stella

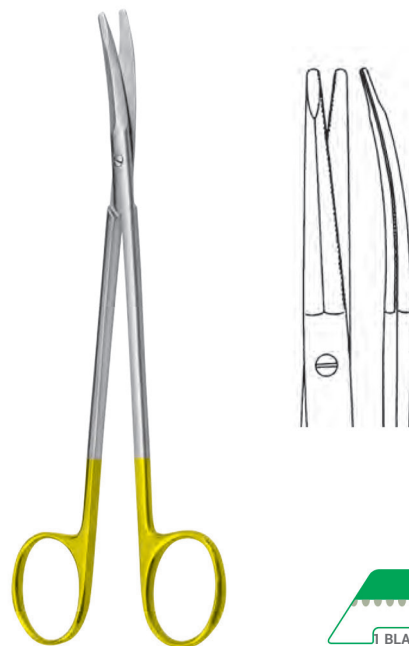

Length	Code
14 cm	BB-2877-14



**Gorney-Freeman**

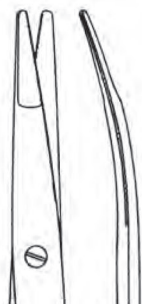

**Length**    **Code**  
18 cm      BB-2878-18

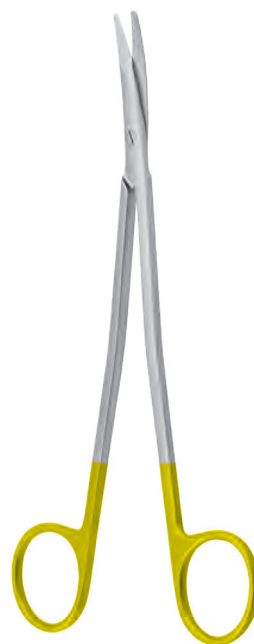

**Length**    **Code**  
23 cm      BB-2879-23

**Freeman-Kaye**

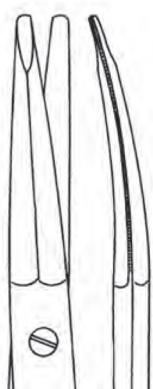

**Length**    **Code**  
18 cm      BB-2880-18

**Freeman-Gorney**



**Length**    **Code**  
23 cm      BB-2881-23

Delicate Surgical Scissors



SCISSORS

Kelly

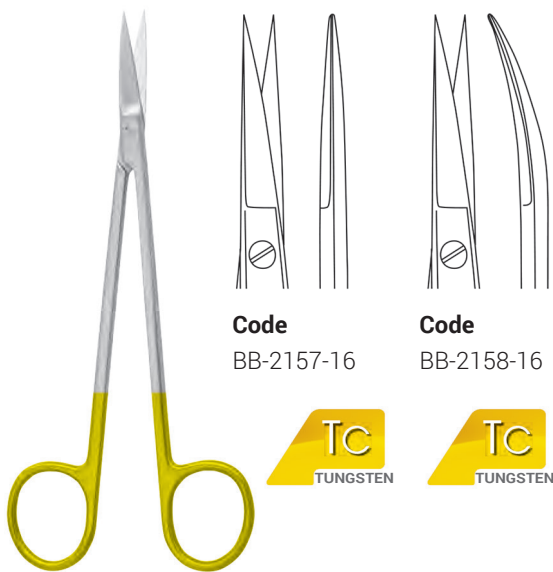

**Code**  
BB-2157-16

**Code**  
BB-2158-16



**Length**    **Code**  
16 cm        BB-2157-16 - BB-2158-16

Joseph

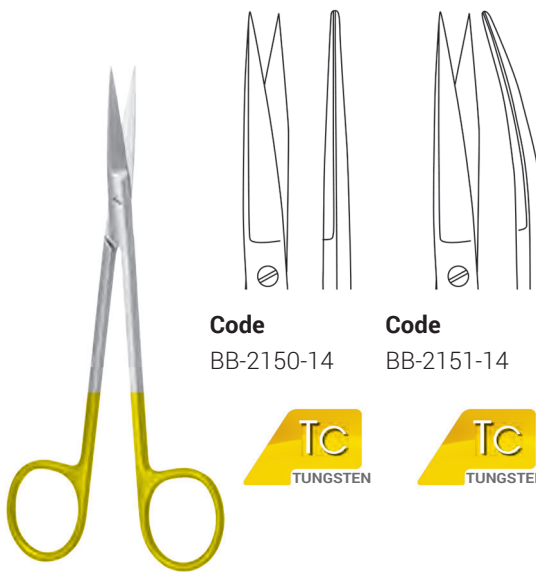

**Code**  
BB-2150-14

**Code**  
BB-2151-14



**Length**    **Code**  
14 cm        BB-2150-14 - BB-2151-14

Goldmann-Fox

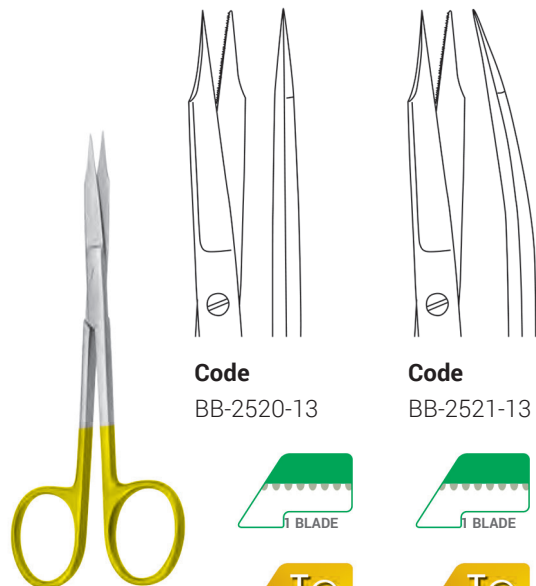

**Code**  
BB-2520-13

**Code**  
BB-2521-13



Gum Scissors

**Length**    **Code**  
13 cm        BB-2520-13 - BB-2521-13

Wagner

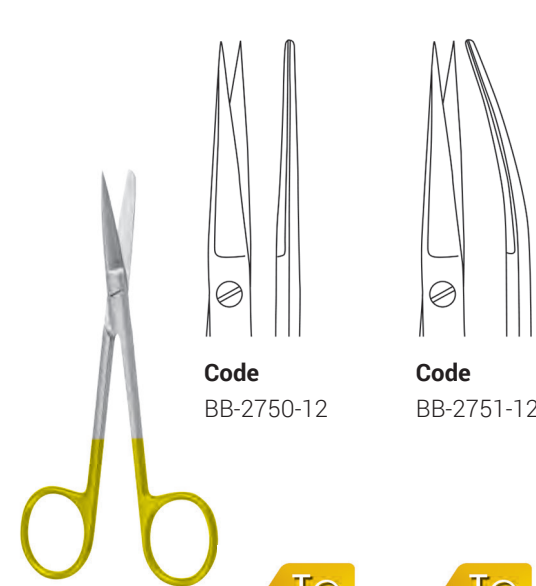

**Code**  
BB-2750-12

**Code**  
BB-2751-12



**Length**    **Code**  
12 cm        BB-2750-12 - BB-2751-12



Iris

<b>Code</b> BB-2110-11	<b>Code</b> BB-2111-11	<b>Code</b> BB-2113-11	<b>Code</b> BB-2111-11W
<b>Length</b> 11 cm	<b>Code</b> BB-2110-11 - BB-2111-11 - BB-2113-11	<b>Length</b> 11 cm	<b>Code</b> BB-2111-11W

Locklin

<b>Length</b> 16 cm	<b>Code</b> BB-2536-16

**Gum Scissors**

Locklin-S

<b>Length</b> 16 cm	<b>Code</b> BB-2537-16

**Gum Scissors**



**DeBakey**

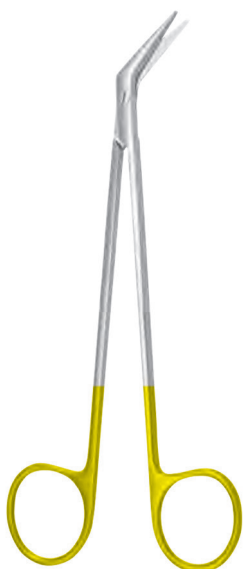

25°

**Code**

BB-2410-16

BB-2410-23

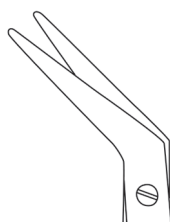

45°

**Code**

BB-2420-16

BB-2420-23

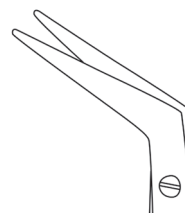

60°

**Code**

BB-2430-16

BB-2430-23



**Length**

**Code**

16 cm BB-2410-16 - BB-2420-16 - BB-2430-16

23 cm BB-2410-23 - BB-2420-23 - BB-2430-23

**Potts-Smith**

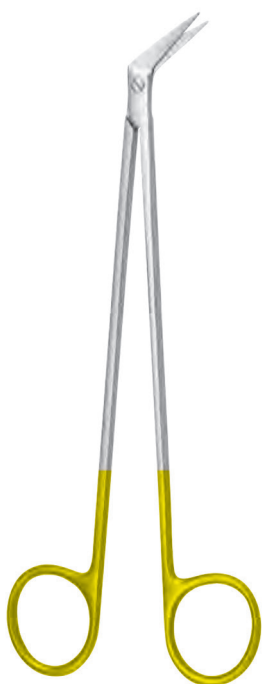

25°

**Code**

BB-2154-19

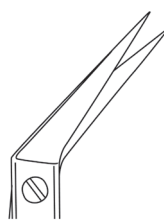

45°

**Code**

BB-2155-19

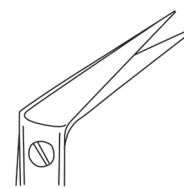

60°

**Code**

BB-2156-19



**Length**

**Code**

19 cm BB-2154-19 - BB-2155-19 - BB-2156-19

**Dietrich-Hegemann**

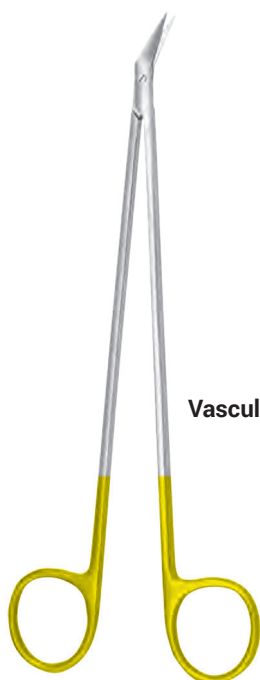

Vascular Scissors



**Code**  
BB-2400-18

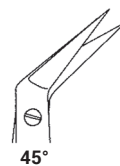

**Code**  
BB-2401-18

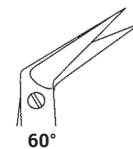

**Code**  
BB-2402-18

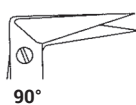

**Code**  
BB-2403-18



**Code**  
BB-2404-18



Dietrich-Hegemann available in petite point paediatric blades

Length	Code
18 cm	BB-2400-18 - BB-2401-18 - BB-2402-18 - BB-2403-18 - BB-2404-18

**Universal**

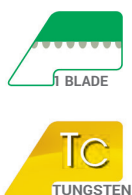
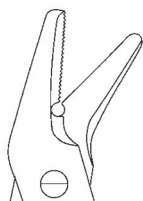

Length	Code
12 cm	BB-2546-12

**Smith**

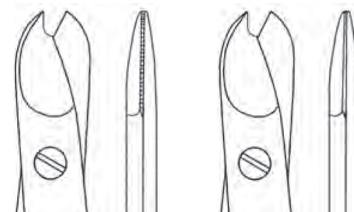
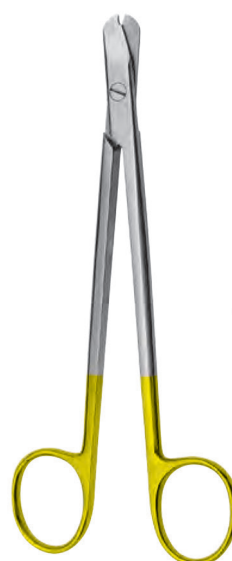

**Code**  
BB-2547-16

**Code**  
BB-2548-16



Length	Code
16 cm	BB-2547-16 - BB2548-16



Mayo

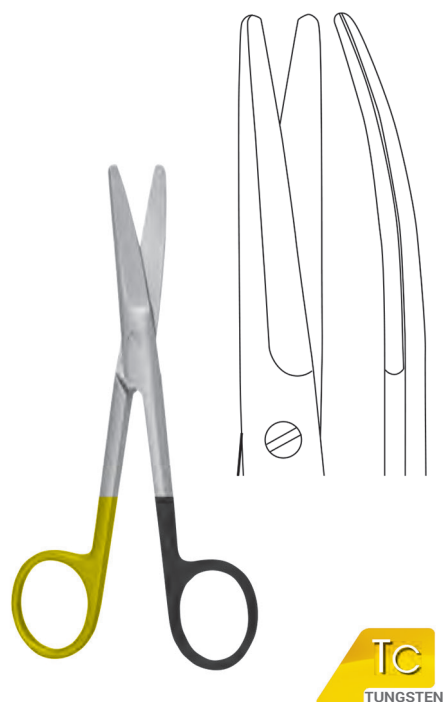

Length	Code
14 cm	BB-5369-14
17 cm	BB-5369-17
23 cm	BB-5369-23

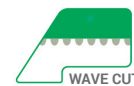
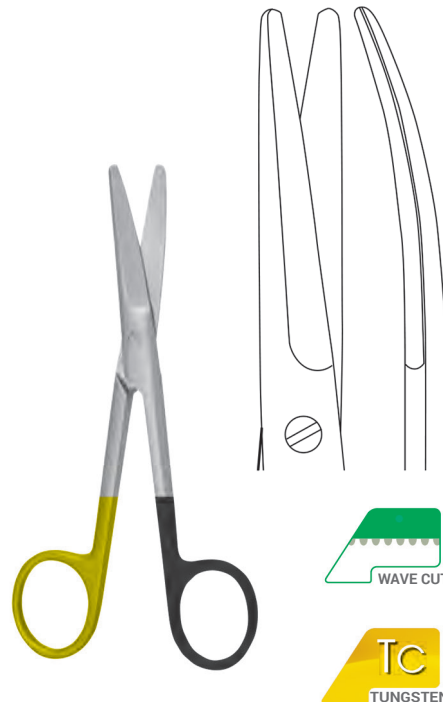

Length	Code
14 cm	BB-5369-14W
17 cm	BB-5369-17W
23 cm	BB-5369-23W

Metzenbaum



Length	Code
14 cm	BB-5201-14W
18 cm	BB-5201-18W
20 cm	BB-5201-20W
23 cm	BB-5201-23W

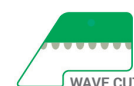

Length	Code
26 cm	BB-5201-26W

## Supercut Titanium-Nitrite Scissors

Scissors with **SUPERCUT TITANIUM-NITRITE** have one razor blade which allows an easy and clean cut through tissue. **TITANIUM NITRITE** coatings:

- The glide quality of the instruments is considerably improved by electrophysical smoothing, resulting in less abrasion and reduced wear.
- The exceptional smoothness means that the scissor blades slide easily, even under maximum stress.
- The smooth surface makes the scissors much easier to clean.
- The coating makes the surface three to five times harder. This multiplies the lifetime of the cutting edges and makes the instruments extremely resistant to scratches and impacts.
- The coating is largely inert, which means that the molecular binding is very chemically resistant. This prevents undesirable reactions when the instruments are immersed in solutions or sterilised.
- Even under intensive use of acid or alkaline solutions, the high level of surface smoothness is retained.
- The inert coating is also stable at high temperatures.

### Characteristics of TIN - coatings:

- 3-5 Times harder than hardened steel.
- Smooth, impervious, ceramic material structure.
- High-grade surface finish, reduced reflection.
- Anti-corrosive, easy to clean surface.
- Far more resistant to solvents and aggressive fluids than uncoated steel.
- Scratch-resistant.
- Temperature-resistant.
- High level of adherence.
- Low friction.



**Characteristic:**  
Black Finish,  
Golden Screw

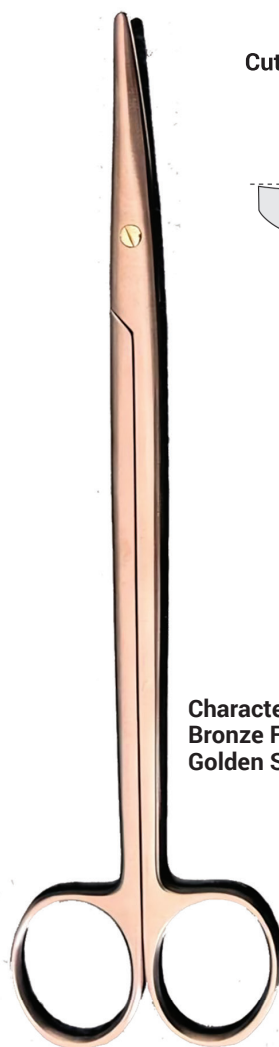

**Characteristic:**  
Bronze Finish,  
Golden Screw

### Cutting Geometry

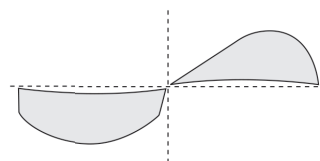

Supercut TITANIUM-NITRIDE Scissors



SCISSORS

Sims

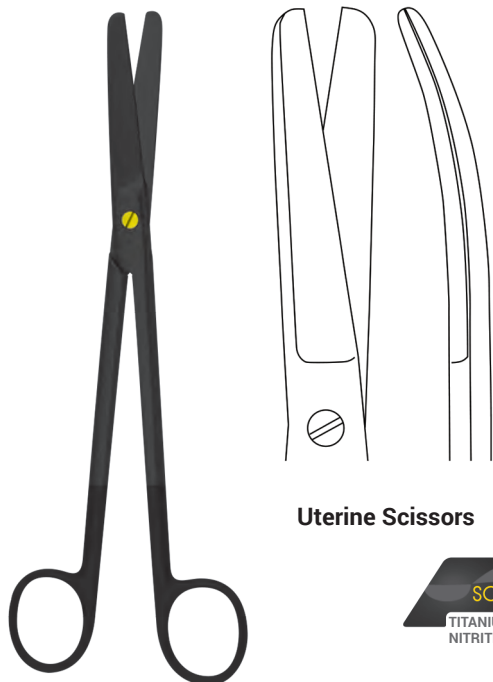

Uterine Scissors



Length	Code
20 cm	BB-5509-20
23 cm	BB-5509-23

Mayo-Harrington

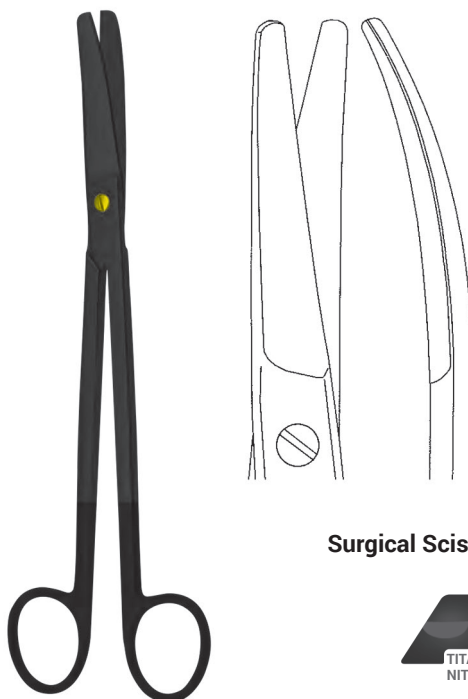

Surgical Scissors



Length	Code
22 cm	BB-5373-22

Mayo

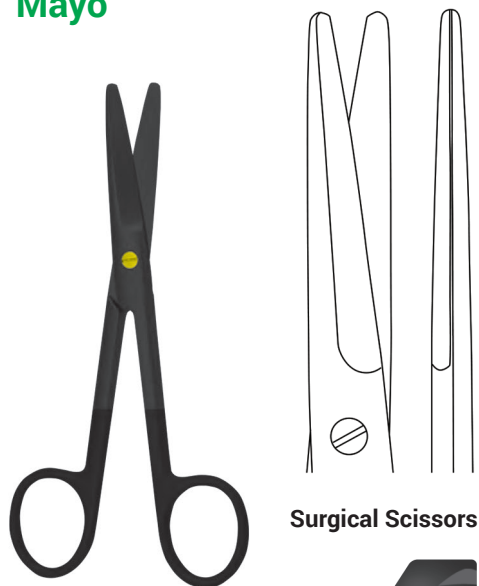

Surgical Scissors



Length	Code
14 cm	BB-5366-14
17 cm	BB-5366-17
23 cm	BB-5366-23

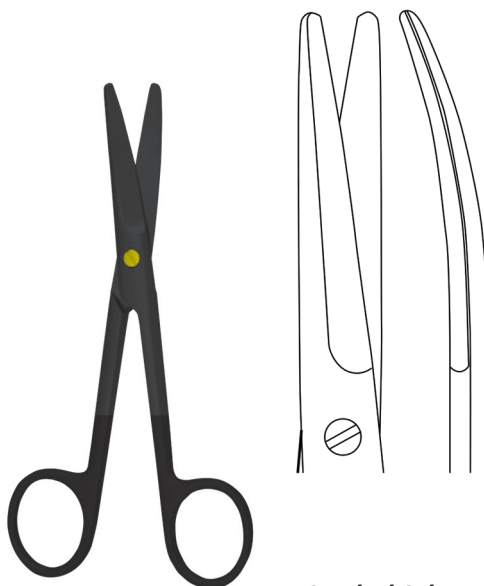

Surgical Scissors



Length	Code
14 cm	BB-5369-14
17 cm	BB-5369-17
23 cm	BB-5369-23



Mayo-Stille

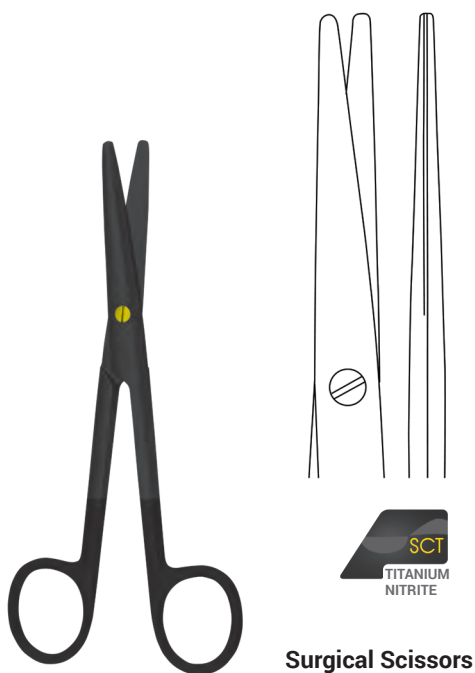

Surgical Scissors

Length	Code
15 cm	BB-5360-15
17 cm	BB-5360-17
21 cm	BB-5360-21

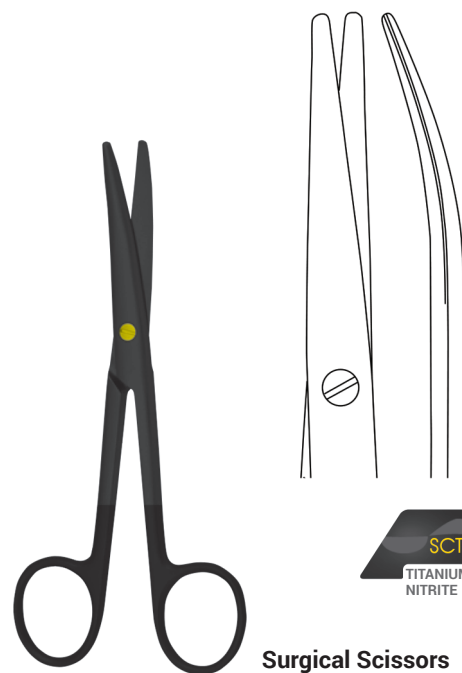

Surgical Scissors

Length	Code
15 cm	BB-5361-15
17 cm	BB-5361-17
21 cm	BB-5361-21

Metzenbaum



Dissecting Scissors

Length	Code
11 cm	BB-5200-11
14 cm	BB-5200-14
18 cm	BB-5200-18
20 cm	BB-5200-20
23 cm	BB-5200-23
25 cm	BB-5200-25
28 cm	BB-5200-28
30 cm	BB-5200-30



Dissecting Scissors

Length	Code
11 cm	BB-5201-11
14 cm	BB-5201-14
18 cm	BB-5201-18
20 cm	BB-5201-20
23 cm	BB-5201-23
25 cm	BB-5201-25
28 cm	BB-5201-28
30 cm	BB-5201-30

Supercut TITANIUM-NITRITE Scissors



SCISSORS

Metzenbaum-Fino



Dissecting Scissors



Length	Code
11 cm	BB-5198-11
14 cm	BB-5198-14
18 cm	BB-5198-18
20 cm	BB-5198-20
23 cm	BB-5198-23
25 cm	BB-5198-25
28 cm	BB-5198-28

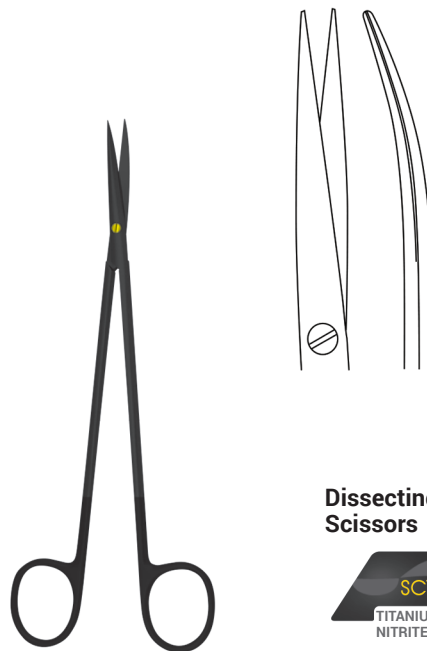

Dissecting Scissors



Length	Code
14 cm	BB-5240-14

Metzenbaum-Fino



Dissecting Scissors



Length	Code
14 cm	BB-5172-14

Lexer

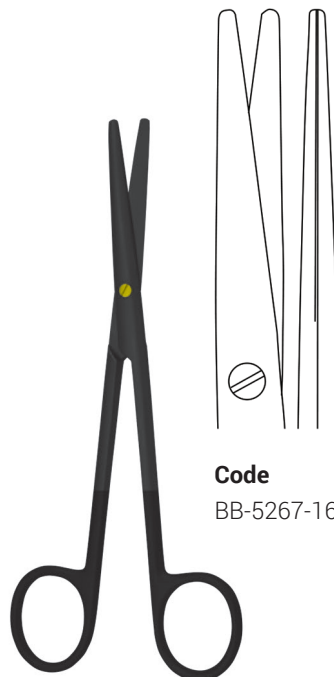

Code  
BB-5267-16



Code  
BB-5266-16

Dissecting Scissors



Length	Code
16 cm	BB-5267-16 - BB-5266-16

SCISSORS

Supercut TITANIUM-NITRITE Scissors



Jameson

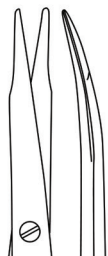

Dissecting Scissors



**Length** 15 cm  
**Code** BB-5312-15

Reynolds



Dissecting Scissors



**Length** 15 cm  
**Code** BB-5314-15

Toennis-Adson



Dissecting Scissors



**Length** 17 cm  
**Code** BB-5297-17

Fomon



Nasal Scissors



**Length** 13 cm  
**Code** BB-5236-13

Supercut TITANIUM-NITRITE Scissors



SCISSORS

Heymann



Nasal Scissors



**Length** 18 cm  
**Code** BB-5320-18

Gregory



**Code**  
BB-BB-5321-18



**Code**  
BB-BB-5322-18

Face-lift Scissors



**Length** 18 cm  
23 cm  
**Code** BB-5321-18 - BB-5322-18  
BB-5321-23 - BB-5322-23

Kelly

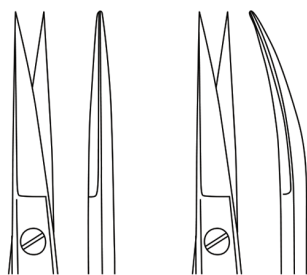

**Code** BB-5157-16  
**Code** BB-5158-16

Delicate Surgical Scissors



**Length** 16 cm  
**Code** BB-5157-16 - BB-5158-16

Joseph

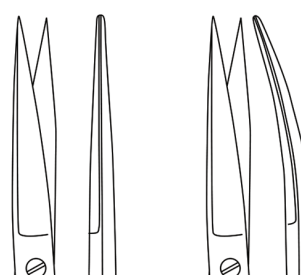

**Code** BB-5150-14  
**Code** BB-5151-14

Delicate Surgical Scissors



**Length** 14 cm  
**Code** BB-5150-14 - BB-5151-14

Supercut TITANIUM-NITRITE Scissors



Stevens Tenotomy

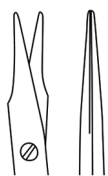
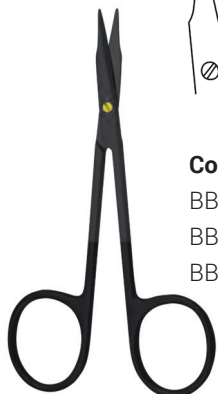

Fig. 1



Fig. 1

**Code**  
BB-5167-12  
BB-5167-13  
BB-5167-18

**Code**  
BB-5168-12  
BB-5168-13  
BB-5168-18



Delicate Surgical Scissors

Length	Code
12 cm	BB-5167-12 - BB-5168-12
13 cm	BB-5167-13 - BB-5168-13
18 cm	BB-5167-18 - BB-5168-18

Iris



**Code**  
BB-5110-11



**Code**  
BB-5111-11



Delicate Surgical Scissors

Length	Code
11 cm	BB-5110-11 - BB-5111-11

Dietrich-Hegemann

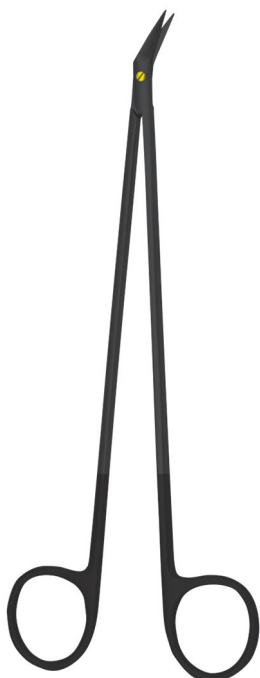

25°

**Code**  
BB-5400-19

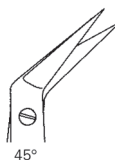

45°

**Code**  
BB-5401-19

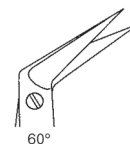

60°

**Code**  
BB-5402-19

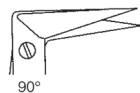

90°

**Code**  
BB-5403-19

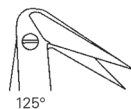

125°

**Code**  
BB-5404-19



Dietrich-Hegemann available in petite point paediatric blades

Vascular Scissors

Length	Code
19 cm	BB-5400-19 - BB-5401-19 - BB-5402-19 - BB-5403-19 - BB-5404-19

Supercut TITANIUM-NITRITE Scissors



# SCISSORS

## Potts-de Martel

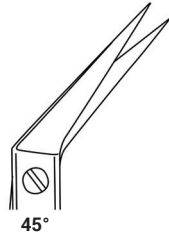

45°

**Length**  
21 cm

**Code**  
BB-5159-21

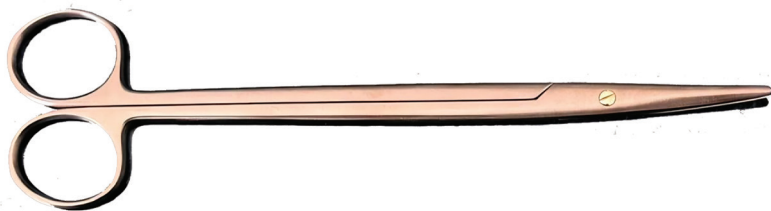
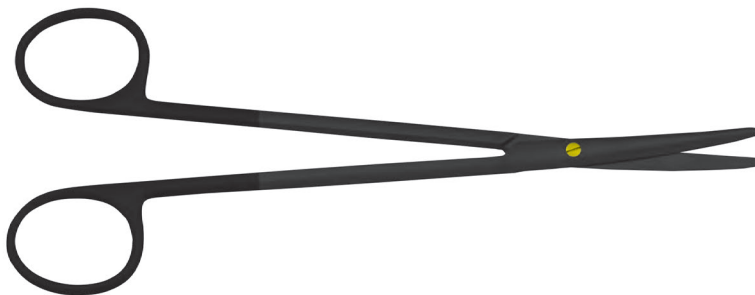
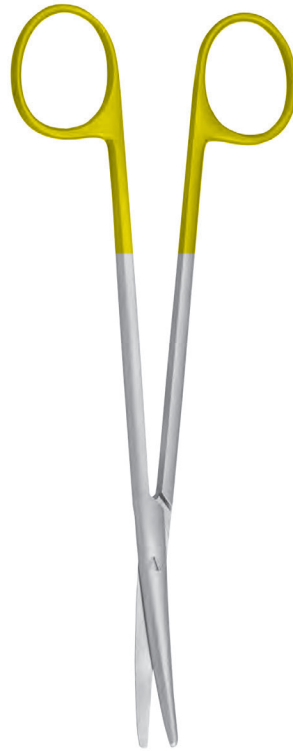

# SCISSORS

## Micro Scissors Round Handle 18 cm



**Description**

- Micro Scissors Round Handle Straight 9 mm Blades
- Micro Scissors Round Handle Curved 9 mm Blades
- Micro Scissors Round Handle Straight 10 mm Blades
- Micro Scissors Round Handle Curved 10 mm Blades

**Code**

- BB-2203-01
- BB-2203-02
- BB-2203-03
- BB-2203-04

## Titanium Micro Scissors Round Handle 18 cm

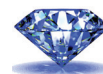

**Description**

- Titanium Micro Scissors  
Round Handle Straight 9 mm Blades
- Titanium Micro Scissors  
Round Handle Curved 9 mm Blades

**Code**

- BB-2205-18T
- BB-2206-18T

**Micro Scissors Flat Handle 18 cm**



**Description**

Micro Scissors Flat Handle Straight 9 mm Blades

**Code**

BB-2207-18

**Titanium Micro Scissors Flat Handle 18 cm**

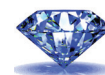

**Description**

Titanium Micro Scissors Flat Handle Straight 9 mm Blades

**Code**

BB-2208-18T

# SCISSORS

## Micro Scissors Flat Handle 18 cm

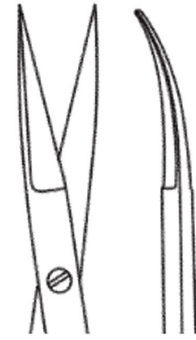

**Description**

Micro Scissors Flat Handle Curved 9 mm Blades

**Code**

BB-2208-18

## Titanium Micro Scissors Flat Handle 18 cm



**Description**

Titanium Micro Scissors Flat Handle Curved 9 mm Blades

**Code**

BB-2209-18T

**Micro Scissors Flat Handle**

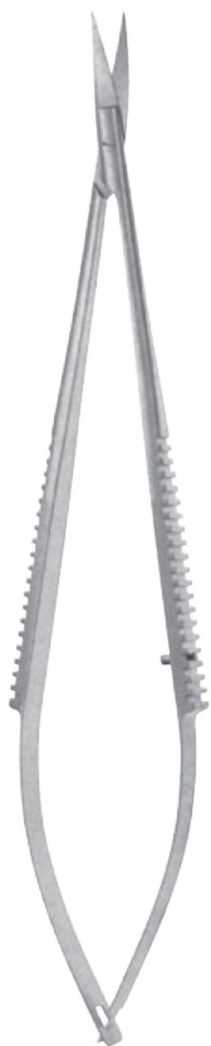

**Description**

- Micro Scissors Flat Handle Straight 9 mm Blades
- Micro Scissors Flat Handle Curved 9 mm Blades
- Micro Scissors Flat Handle Straight 9 mm Blades
- Micro Scissors Flat Handle Curved 9 mm Blades
- Micro Scissors Flat Handle Straight 9 mm Blades
- Micro Scissors Flat Handle Curved 9 mm Blades
- Micro Scissors Flat Handle Straight 9 mm Blades
- Micro Scissors Flat Handle Curved 9 mm Blades

**Length**

- 15 cm
- 15 cm
- 18 cm
- 18 cm
- 21 cm
- 21 cm
- 23 cm
- 23 cm

**Code**

- BB-2209-15
- BB-2210-15
- BB-2209-18
- BB-2210-18
- BB-2209-21
- BB-2210-21
- BB-2209-23
- BB-2210-23



# SCISSORS

## Micro Scissors Round Handle 18 cm



**Description**

- Micro Scissors Round Handle Straight 9 mm Blades
- Micro Scissors Round Handle Curved 9 mm Blades
- Micro Scissors Round Handle Straight 10 mm Blades
- Micro Scissors Round Handle Curved 10 mm Blades

**Code**

- BB-2200-18
- BB-2201-18
- BB-2202-18
- BB-2203-18

## Titanium Micro Scissors Round Handle 18 cm

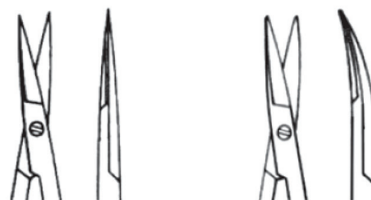

**Description**

- Titanium Micro Scissors Round Handle Straight 9 mm Blades
- Titanium Micro Scissors Round Handle Curved 9 mm Blades

**Code**

- BB-2205-18T
- BB-2206-18T

Titanium Micro Scissors Bayonet Flat Handle 23 cm

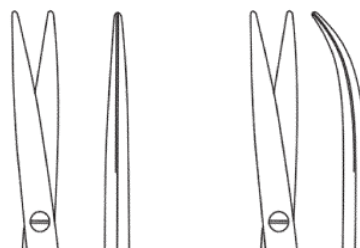
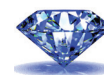

SCISSORS

**Description**

Titanium Micro Scissors Flat Handle Straight 9 mm Blades

**Length**

23 cm

**Code**

BB-2218-23T

Titanium Micro Scissors Flat Handle Curved 9 mm Blades

23 cm

BB-2219-23T

Titanium Micro Scissors Flat Handle Straight 10 mm Blades

23 cm

BB-2220-23T

Titanium Micro Scissors Flat Handle Curved 10 mm Blades

23 cm

BB-2221-23T

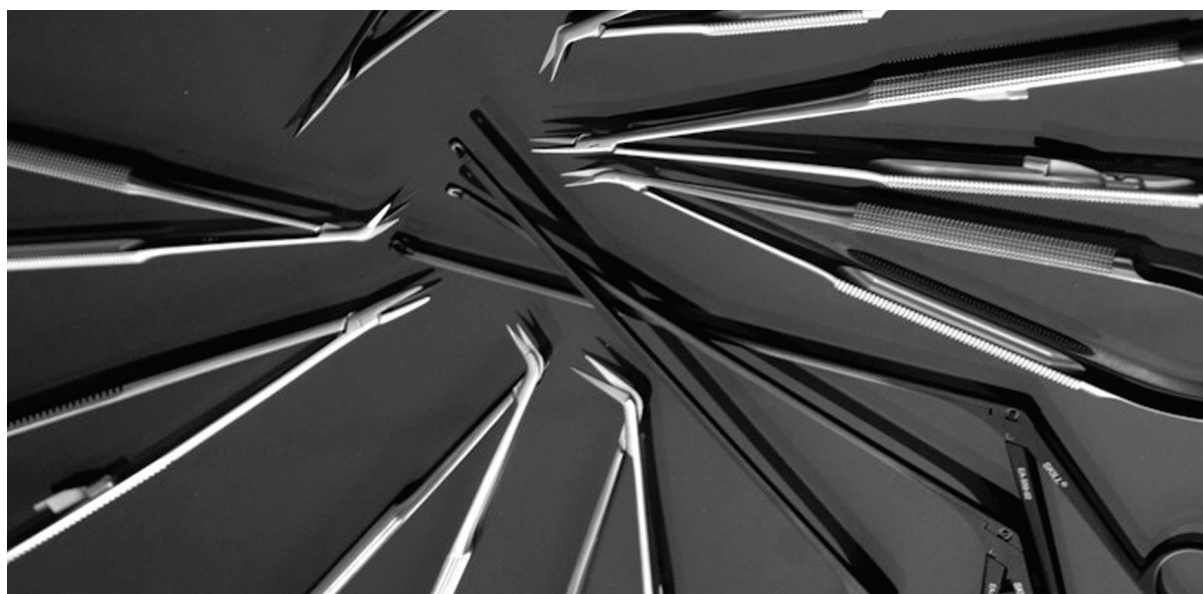

SCISSORS

Micro Vascular Scissors Flat Handle 7 mm Micro Blades 10 cm

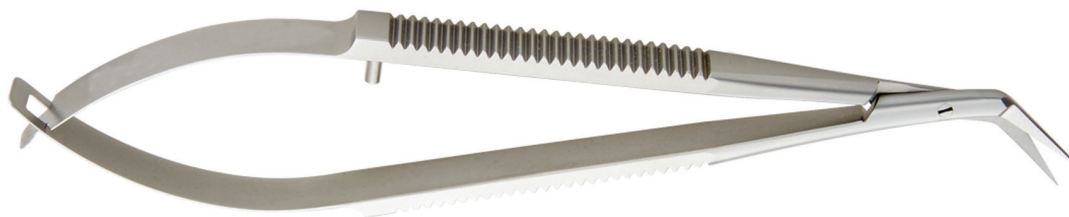

25°



45°



60°



90°



125°



**Description**

Micro Vascular Scissors Flat Handle 25° Angled Blades

Micro Vascular Scissors Flat Handle 45° Angled Blades

Micro Vascular Scissors Flat Handle 60° Angled Blades

Micro Vascular Scissors Flat Handle 90° Angled Blades

Micro Vascular Scissors Flat Handle 125°/12 Angled Blades

**Length**

10 cm

10 cm

10 cm

10 cm

10 cm

**Code**

BB-8903-25

BB-8903-45

BB-8903-60

BB-8903-90

BB-8903-125

Micro Vascular Scissors Flat Handle 7 mm Micro Blades 10 cm

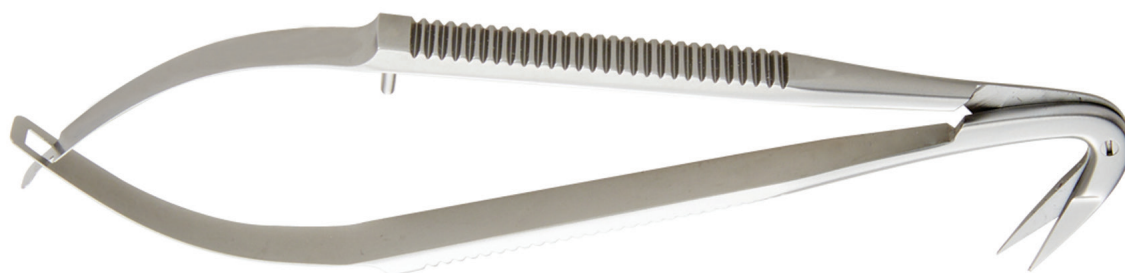

125°

**Description**

Micro Vascular Scissors Flat Handle 125°/12 Angled Blades

**Length**

10 cm

**Code**

BB-8903-125

**Micro Vascular Scissors Flat Handle 10 mm Blades 16 cm**



25°



45°



60°



90°



125°



**Description**

Micro Vascular Scissors Flat Handle 25° Angled Blades

**Length**

16 cm

**Code**

BB-8905-25

Micro Vascular Scissors Flat Handle 45° Angled Blades

16 cm

BB-8905-45

Micro Vascular Scissors Flat Handle 60° Angled Blades

16 cm

BB-8905-60

Micro Vascular Scissors Flat Handle 90° Angled Blades

16 cm

BB-8905-90

Micro Vascular Scissors Flat Handle 125°/12 Angled Blades

16 cm

BB-8905-125

**Micro Vascular Scissors Flat Handle 14 mm Blades 12 cm**

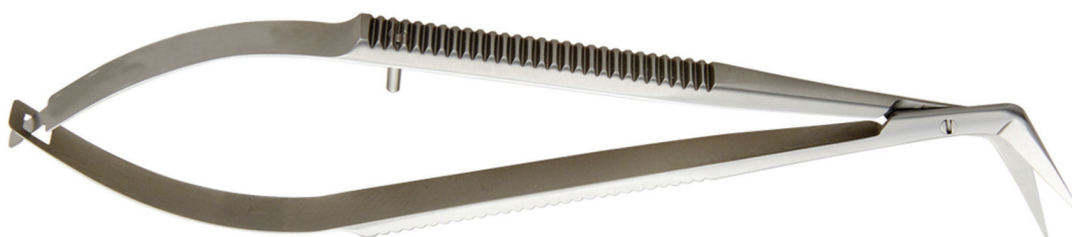

**Description**

Micro Vascular Scissors Flat Handle 25° Angled Blades

**Length**

12 cm

**Code**

BB-8904-25

Micro Vascular Scissors Flat Handle 45° Angled Blades

12 cm

BB-8904-45

Micro Vascular Scissors Flat Handle 60° Angled Blades

12 cm

BB-8904-60

Micro Vascular Scissors Flat Handle 90° Angled Blades

12 cm

BB-8904-90

Micro Vascular Scissors Flat Handle 125°/12 Angled Blades

12 cm

BB-8904-125

# SCISSORS

## Micro Vascular Scissors Flat Handle 18 cm



25°



45°



60°



90°



125°



**Description**

Micro Vascular Scissors Flat Handle 25° Angled Blades

Micro Vascular Scissors Flat Handle 45° Angled Blades

Micro Vascular Scissors Flat Handle 60° Angled Blades

Micro Vascular Scissors Flat Handle 90° Angled Blades

Micro Vascular Scissors Flat Handle 125°/12 Angled Blades

**Length**

18 cm

18 cm

18 cm

18 cm

18 cm

**Code**

BB-8906-25

BB-8906-45

BB-8906-60

BB-8906-90

BB-8906-125



25°



45°



60°



90°



125°



**Description**

Micro Vascular Scissors Flat Handle 25° Angled Blades

Micro Vascular Scissors Flat Handle 45° Angled Blades

Micro Vascular Scissors Flat Handle 60° Angled Blades

Micro Vascular Scissors Flat Handle 90° Angled Blades

Micro Vascular Scissors Flat Handle 125°/12 Angled Blades

**Length**

18 cm

18 cm

18 cm

18 cm

18 cm

**Code**

BB-8907-25

BB-8907-45

BB-8907-60

BB-8907-90

BB-8907-125

Micro Vascular Scissors Flat Handle 21 cm

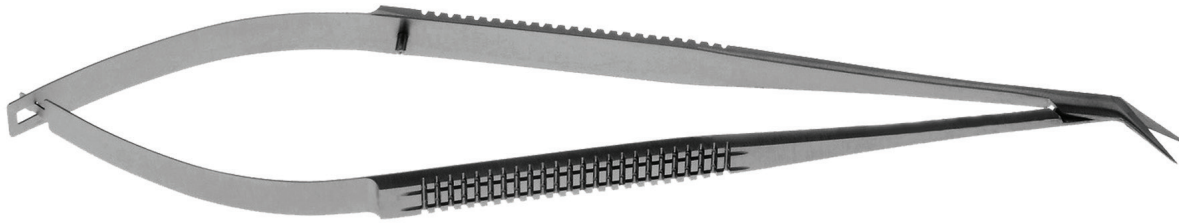

25°      45°      60°      90°      125°

7 mm

**Description**

- Micro Vascular Scissors Flat Handle 25° Angled Blades
- Micro Vascular Scissors Flat Handle 45° Angled Blades
- Micro Vascular Scissors Flat Handle 60° Angled Blades
- Micro Vascular Scissors Flat Handle 90° Angled Blades
- Micro Vascular Scissors Flat Handle 125°/12 Angled Blades

**Length**

- 21 cm
- 21 cm
- 21 cm
- 21 cm
- 21 cm

**Code**

- BB-8900-25
- BB-8900-45
- BB-8900-60
- BB-8900-90
- BB-8900-125



25°      45°      60°      90°      125°

10 mm

**Description**

- Micro Vascular Scissors Flat Handle 25° Angled Blades
- Micro Vascular Scissors Flat Handle 45° Angled Blades
- Micro Vascular Scissors Flat Handle 60° Angled Blades
- Micro Vascular Scissors Flat Handle 90° Angled Blades
- Micro Vascular Scissors Flat Handle 125°/12 Angled Blades

**Length**

- 21 cm
- 21 cm
- 21 cm
- 21 cm
- 21 cm

**Code**

- BB-8901-25
- BB-8901-45
- BB-8901-60
- BB-8901-90
- BB-8901-125

SCISSORS

Micro Vascular Scissors Round Handle 12 cm



25°



45°



60°



90°



125°



7 mm

**Description**

Micro Vascular Scissors Round Handle 25° Angled Blades

**Length**

12 cm

**Code**

BB-8909-25

Micro Vascular Scissors Round Handle 45° Angled Blades

12 cm

BB-8909-45

Micro Vascular Scissors Round Handle 60° Angled Blades

12 cm

BB-8909-60

Micro Vascular Scissors Round Handle 90° Angled Blades

12 cm

BB-8909-90

Micro Vascular Scissors Round Handle 125°/12 Angled Blades

12 cm

BB-8909-125



25°



45°



60°



90°



125°



10 mm

**Description**

Micro Vascular Scissors Round Handle 25° Angled Blades

**Length**

12 cm

**Code**

BB-8910-25

Micro Vascular Scissors Round Handle 45° Angled Blades

12 cm

BB-8910-45

Micro Vascular Scissors Round Handle 60° Angled Blades

12 cm

BB-8910-60

Micro Vascular Scissors Round Handle 90° Angled Blades

12 cm

BB-8910-90

Micro Vascular Scissors Round Handle 125°/12 Angled Blades

12 cm

BB-8910-125

**Micro Vascular Scissors Round Handle 16 cm**

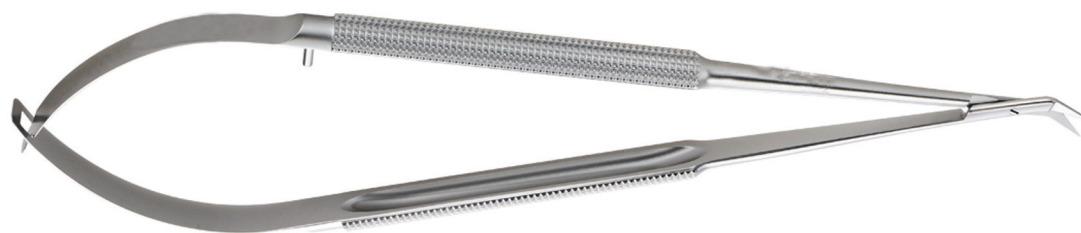

**7 mm**

**Description**

Micro Vascular Scissors Round Handle 25° Angled Blades

**Length**

16 cm

**Code**

BB-8912-25

Micro Vascular Scissors Round Handle 45° Angled Blades

16 cm

BB-8912-45

Micro Vascular Scissors Round Handle 60° Angled Blades

16 cm

BB-8912-60

Micro Vascular Scissors Round Handle 90° Angled Blades

16 cm

BB-8912-90

Micro Vascular Scissors Round Handle 125°/12 Angled Blades

16 cm

BB-8912-125



**10 mm**

**Description**

Micro Vascular Scissors Round Handle 25° Angled Blades

**Length**

16 cm

**Code**

BB-8913-25

Micro Vascular Scissors Round Handle 45° Angled Blades

16 cm

BB-8913-45

Micro Vascular Scissors Round Handle 60° Angled Blades

16 cm

BB-8913-60

Micro Vascular Scissors Round Handle 90° Angled Blades

16 cm

BB-8913-90

Micro Vascular Scissors Round Handle 125°/12 Angled Blades

16 cm

BB-8913-125

SCISSORS

Micro Vascular Scissors Round Handle 18 cm



25°      45°      60°      90°      125°

7 mm

Description	Length	Code
Micro Vascular Scissors Round Handle 25° Angled Blades	18 cm	BB-8915-25
Micro Vascular Scissors Round Handle 45° Angled Blades	18 cm	BB-8915-45
Micro Vascular Scissors Round Handle 60° Angled Blades	18 cm	BB-8915-60
Micro Vascular Scissors Round Handle 90° Angled Blades	18 cm	BB-8915-90
Micro Vascular Scissors Round Handle 125°/12 Angled Blades	18 cm	BB-8915-125



25°      45°      60°      90°      125°

10 mm

Description	Length	Code
Micro Vascular Scissors Round Handle 25° Angled Blades	18 cm	BB-8916-25
Micro Vascular Scissors Round Handle 45° Angled Blades	18 cm	BB-8916-45
Micro Vascular Scissors Round Handle 60° Angled Blades	18 cm	BB-8916-60
Micro Vascular Scissors Round Handle 90° Angled Blades	18 cm	BB-8916-90
Micro Vascular Scissors Round Handle 125°/12 Angled Blades	18 cm	BB-8916-125

**Micro Vascular Scissors Round Handle 21 cm**

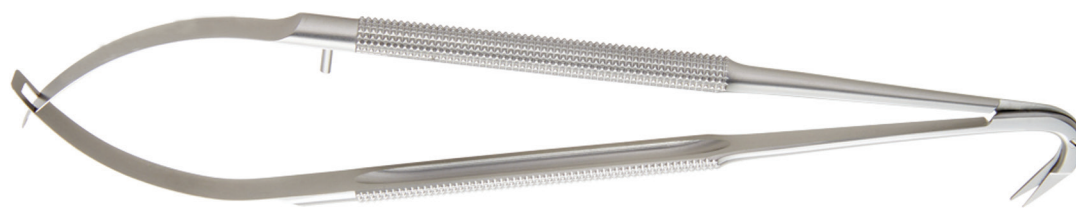

25°      45°      60°      90°      125°

**7 mm**

**Description**

Micro Vascular Scissors Round Handle 25° Angled Blades

**Length**

21 cm

**Code**

BB-8918-25

Micro Vascular Scissors Round Handle 45° Angled Blades

21 cm

BB-8918-45

Micro Vascular Scissors Round Handle 60° Angled Blades

21 cm

BB-8918-60

Micro Vascular Scissors Round Handle 90° Angled Blades

21 cm

BB-8918-90

Micro Vascular Scissors Round Handle 125°/12 Angled Blades

21 cm

BB-8918-125



25°      45°      60°      90°      125°

**10 mm**

**Description**

Micro Vascular Scissors Round Handle 25° Angled Blades

**Length**

21 cm

**Code**

BB-8919-25

Micro Vascular Scissors Round Handle 45° Angled Blades

21 cm

BB-8919-45

Micro Vascular Scissors Round Handle 60° Angled Blades

21 cm

BB-8919-60

Micro Vascular Scissors Round Handle 90° Angled Blades

21 cm

BB-8919-90

Micro Vascular Scissors Round Handle 125°/12 Angled Blades

21 cm

BB-8919-125

**Jacobson Micro Scissors Flat Handle Bayonet**



Description	Length	Code
Jacobson Micro Scissors Flat Handle Bayonet 14 mm Blade Straight	18 cm	BB-9801-18
Jacobson Micro Scissors Flat Handle Bayonet 14 mm Blade Straight	21 cm	BB-9801-21
Jacobson Micro Scissors Flat Handle Bayonet 14 mm Blade Straight	22 cm	BB-9801-22
Jacobson Micro Scissors Flat Handle Bayonet 14 mm Blade Straight	23 cm	BB-9801-23

Description	Length	Code
Jacobson Micro Scissors Flat Handle Bayonet 14 mm Blade Curved	18 cm	BB-9802-18
Jacobson Micro Scissors Flat Handle Bayonet 14 mm Blade Curved	21 cm	BB-9802-21
Jacobson Micro Scissors Flat Handle Bayonet 14 mm Blade Curved	22 cm	BB-9802-22
Jacobson Micro Scissors Flat Handle Bayonet 14 mm Blade Curved	23 cm	BB-9802-23

**Jacobson Micro Scissors Flat Handle Bayonet**



Description	Length	Code
Jacobson Micro Scissors Flat Handle Bayonet 12 mm 45°	18 cm	BB-9803-18
Jacobson Micro Scissors Flat Handle Bayonet 12 mm 45°	21 cm	BB-9803-21
Jacobson Micro Scissors Flat Handle Bayonet 12 mm 45°	22 cm	BB-9803-22
Jacobson Micro Scissors Flat Handle Bayonet 12 mm 45°	23 cm	BB-9803-23



## Jacobson Micro Scissors Flat Handle Bayonet



### Description

Jacobson Micro Scissors Flat Handle Bayonet 12 mm 125°

Jacobson Micro Scissors Flat Handle Bayonet 12 mm 125°

Jacobson Micro Scissors Flat Handle Bayonet 12 mm 125°

Jacobson Micro Scissors Flat Handle Bayonet 12 mm 125°

### Length

18 cm

21 cm

22 cm

23 cm

### Code

BB-9804-18

BB-9804-21

BB-9804-22

BB-9804-23



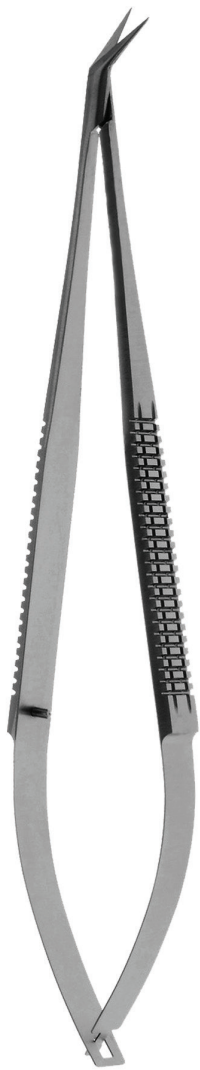
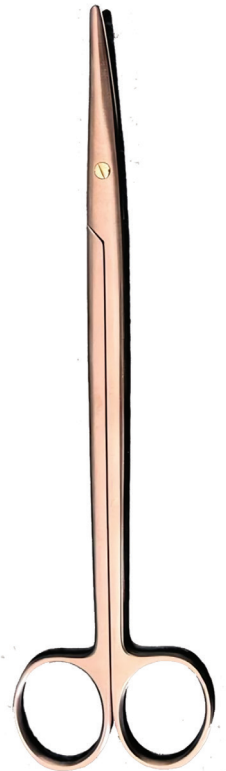

# SKILL<sup>®</sup>

Surgical Instruments

## MICRO FORCEPS

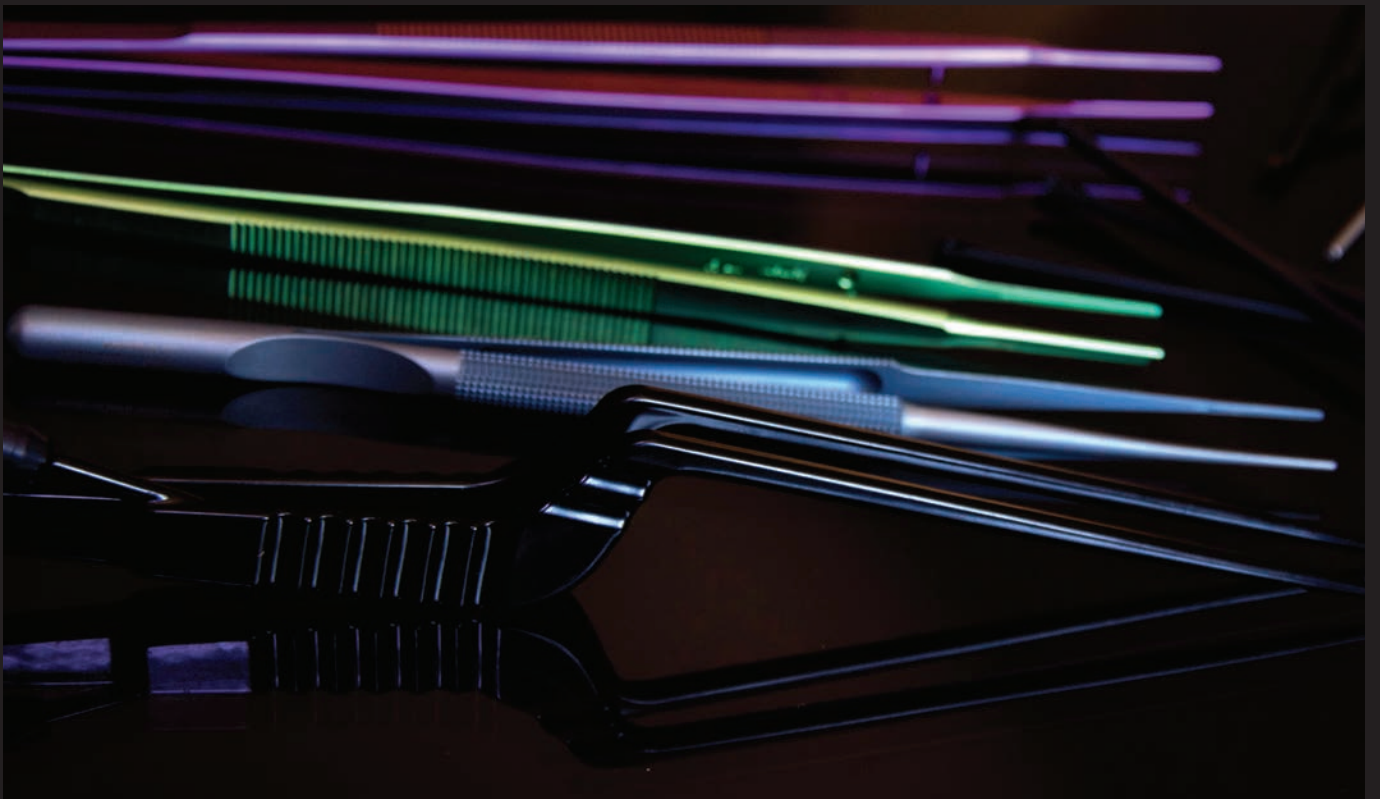



# Index

## Micro Forceps

Titanium Micro Ring Forceps Round Handle Counterbalance	116
Micro Ring Forceps Round Handle Counterbalance	116
Titanium Micro Ring Forceps Round Handle	117
Micro Ring Forceps Round Handle	117
Titanium Micro Forceps Round Handle Counterbalance	118
Micro Forceps Round Handle Counterbalance	118
Titanium Micro Forceps Round Handle	119
Micro Forceps Round Handle	120
Titanium Micro DeBakey Forceps Round Handle Counterbalance	121
Micro DeBakey Forceps Round Handle Counterbalance	121
Titanium Micro DeBakey Forceps Round Handle	122
Micro DeBakey Forceps Round Handle	122
Titanium Gerald DeBakey Forceps Flat Handle	123
Gerald DeBakey Forceps Flat Handle	123
Titanium Gerald Forceps Flat Handle	124
Gerald Forceps Flat Handle	124
Titanium Gerald Ring Forceps Flat Handle	125
Gerald Ring Forceps Flat Handle	125
Resano Forceps Multi Toothed 230 mm	125
Adson Forceps	126-127
Bonneys Forceps Toothed 18 cm	128
Gillies Forceps Toothed 15 cm	129
Titanium Gillies Forceps Toothed 15 cm	129
McIndoe Forceps Plain 15 cm	129
Titanium McIndoe Forceps Plain 15 cm	130
Russian Forceps	130
Treves Forceps Toothed 15 cm	131
DeBakey Vascular Forceps	131-132
Cushing Forceps TC Straight	132

**Titanium Micro Ring Forceps Round Handle Counterbalance**



**Straight  
Gerade  
1 x 0.5 mm**



**Curved  
Gerade  
1 x 0.5 mm**



**Straight  
Gerade  
2 x 1 mm**



**Curved  
Gerade  
2 x 1 mm**



**Description**

Titanium Micro Ring Forceps Round Handle	1 x 0.5 mm
Titanium Micro Ring Forceps Round Handle	2 x 1.0 mm
Titanium Micro Ring Forceps Round Handle	1 x 0.5 mm
Titanium Micro Ring Forceps Round Handle	2 x 1.0 mm
Titanium Micro Ring Forceps Round Handle	1 x 0.5 mm
Titanium Micro Ring Forceps Round Handle	2 x 1.0 mm
Titanium Micro Ring Forceps Round Handle	1 x 0.5 mm
Titanium Micro Ring Forceps Round Handle	2 x 1.0 mm

**Length**

15 cm
15 cm
18 cm
18 cm
21 cm
21 cm
23 cm
23 cm

**Code**

BD-1310-15T
BD-1311-15T
BD-1310-18T
BD-1311-18T
BD-1310-21T
BD-1311-21T
BD-1310-23T
BD-1311-23T

**Micro Ring Forceps Round Handle Counterbalance**



**Straight  
Gerade  
1 x 0.5 mm**



**Curved  
Gerade  
1 x 0.5 mm**



**Straight  
Gerade  
2 x 1 mm**



**Curved  
Gerade  
2 x 1 mm**



**Description**

Micro Ring Forceps Round Handle	1 x 0.5 mm
Micro Ring Forceps Round Handle	2 x 1.0 mm
Micro Ring Forceps Round Handle	1 x 0.5 mm
Micro Ring Forceps Round Handle	2 x 1.0 mm
Micro Ring Forceps Round Handle	1 x 0.5 mm
Micro Ring Forceps Round Handle	2 x 1.0 mm
Micro Ring Forceps Round Handle	1 x 0.5 mm
Micro Ring Forceps Round Handle	2 x 1.0 mm

**Length**

15 cm
15 cm
18 cm
18 cm
21 cm
21 cm
23 cm
23 cm

**Code**

BD-1310-15
BD-1311-15
BD-1310-18
BD-1311-18
BD-1310-21
BD-1311-21
BD-1310-23
BD-1311-23

**Titanium Micro Ring Forceps Round Handle**



**Straight**  
**Gerade**  
1 x 0.5 mm



**Curved**  
**Gerade**  
1 x 0.5 mm



**Straight**  
**Gerade**  
2 x 1 mm



**Curved**  
**Gerade**  
2 x 1 mm



**Description**

Titanium Micro Ring Forceps Round Handle	1 x 0.5 mm
Titanium Micro Ring Forceps Round Handle	2 x 1.0 mm
Titanium Micro Ring Forceps Round Handle	1 x 0.5 mm
Titanium Micro Ring Forceps Round Handle	2 x 1.0 mm
Titanium Micro Ring Forceps Round Handle	1 x 0.5 mm
Titanium Micro Ring Forceps Round Handle	2 x 1.0 mm
Titanium Micro Ring Forceps Round Handle	1 x 0.5 mm
Titanium Micro Ring Forceps Round Handle	2 x 1.0 mm

**Length**

15 cm
15 cm
18 cm
18 cm
21 cm
21 cm
23 cm
23 cm

**Code**

BD-1335-15T
BD-1336-15T
BD-1335-18T
BD-1336-18T
BD-1335-21T
BD-1336-21T
BD-1335-23T
BD-1336-23T

**Micro Ring Forceps Round Handle**



**Straight**  
**Gerade**  
1 x 0.5 mm



**Curved**  
**Gerade**  
1 x 0.5 mm



**Straight**  
**Gerade**  
2 x 1 mm



**Curved**  
**Gerade**  
2 x 1 mm



**Description**

Micro Ring Forceps Round Handle	1 x 0.5 mm
Micro Ring Forceps Round Handle	2 x 1.0 mm
Micro Ring Forceps Round Handle	1 x 0.5 mm
Micro Ring Forceps Round Handle	2 x 1.0 mm
Micro Ring Forceps Round Handle	1 x 0.5 mm
Micro Ring Forceps Round Handle	2 x 1.0 mm
Micro Ring Forceps Round Handle	1 x 0.5 mm
Micro Ring Forceps Round Handle	2 x 1.0 mm

**Length**

15 cm
15 cm
18 cm
18 cm
21 cm
21 cm
23 cm
23 cm

**Code**

BD-1335-15
BD-1336-15
BD-1335-18
BD-1336-18
BD-1335-21
BD-1336-21
BD-1335-23
BD-1336-23

**Titanium Micro Forceps Round Handle Counterbalance**

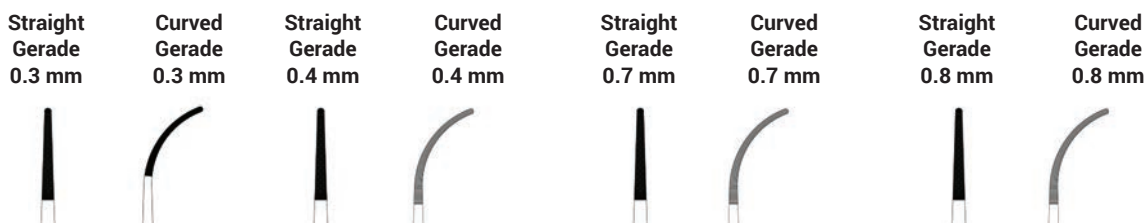

Description	Length	Code
Titanium Micro Forceps Round Handle 0.3 mm Diamond Dust Insert	15 cm	BD-1312-15T
Titanium Micro Forceps Round Handle 0.4 mm Diamond Dust Insert	15 cm	BD-1313-15T
Titanium Micro Forceps Round Handle 0.7 mm Diamond Dust Insert	15 cm	BD-1314-15T
Titanium Micro Forceps Round Handle 0.8 mm Diamond Dust Insert	15 cm	BD-1315-15T
Titanium Micro Forceps Round Handle 0.3 mm Diamond Dust Insert	18 cm	BD-1312-18T
Titanium Micro Forceps Round Handle 0.4 mm Diamond Dust Insert	18 cm	BD-1313-18T
Titanium Micro Forceps Round Handle 0.7 mm Diamond Dust Insert	18 cm	BD-1314-18T
Titanium Micro Forceps Round Handle 0.8 mm Diamond Dust Insert	18 cm	BD-1315-18T
Titanium Micro Forceps Round Handle 0.3 mm Diamond Dust Insert	21 cm	BD-1312-21T
Titanium Micro Forceps Round Handle 0.4 mm Diamond Dust Insert	21 cm	BD-1313-21T
Titanium Micro Forceps Round Handle 0.7 mm Diamond Dust Insert	21 cm	BD-1314-21T
Titanium Micro Forceps Round Handle 0.8 mm Diamond Dust Insert	21 cm	BD-1315-21T

**Micro Forceps Round Handle Counterbalance**

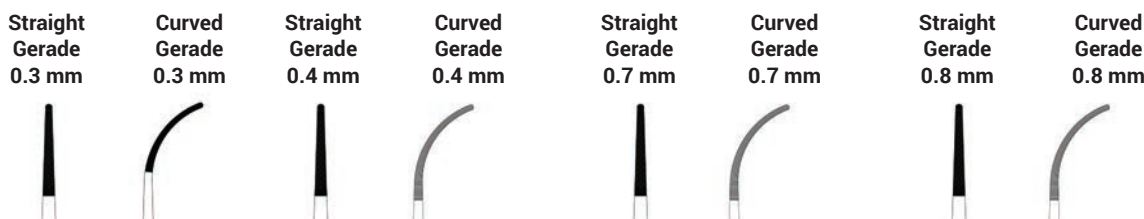

Description	Length	Code
Micro Forceps Round Handle 0.3 mm Diamond Dust Insert	15 cm	BD-1312-15
Micro Forceps Round Handle 0.4 mm Diamond Dust Insert	15 cm	BD-1313-15
Micro Forceps Round Handle 0.7 mm Diamond Dust Insert	15 cm	BD-1314-15
Micro Forceps Round Handle 0.8 mm Diamond Dust Insert	15 cm	BD-1315-15
Micro Forceps Round Handle 0.3 mm Diamond Dust Insert	18 cm	BD-1312-18
Micro Forceps Round Handle 0.4 mm Diamond Dust Insert	18 cm	BD-1313-18
Micro Forceps Round Handle 0.7 mm Diamond Dust Insert	18 cm	BD-1314-18
Micro Forceps Round Handle 0.8 mm Diamond Dust Insert	18 cm	BD-1315-18
Micro Forceps Round Handle 0.3 mm Diamond Dust Insert	21 cm	BD-1312-21
Micro Forceps Round Handle 0.4 mm Diamond Dust Insert	21 cm	BD-1313-21
Micro Forceps Round Handle 0.7 mm Diamond Dust Insert	21 cm	BD-1314-21
Micro Forceps Round Handle 0.8 mm Diamond Dust Insert	21 cm	BD-1315-21

## Titanium Micro Forceps Round Handle



**Straight  
Gerade  
0.3 mm**



**Curved  
Gerade  
0.3 mm**



**Straight  
Gerade  
0.4 mm**



**Curved  
Gerade  
0.4 mm**



**Straight  
Gerade  
0.7 mm**



**Curved  
Gerade  
0.7 mm**



**Straight  
Gerade  
0.8 mm**



**Curved  
Gerade  
0.8 mm**



### Description

Titanium Micro Forceps Round Handle	0.3 mm Diamond Dust Insert	15 cm	BD-1338-15T
Titanium Micro Forceps Round Handle	0.4 mm Diamond Dust Insert	15 cm	BD-1339-15T
Titanium Micro Forceps Round Handle	0.7 mm Diamond Dust Insert	15 cm	BD-1340-15T
Titanium Micro Forceps Round Handle	0.8 mm Diamond Dust Insert	15 cm	BD-1341-15T
Titanium Micro Forceps Round Handle	0.3 mm Diamond Dust Insert	18 cm	BD-1338-18T
Titanium Micro Forceps Round Handle	0.4 mm Diamond Dust Insert	18 cm	BD-1339-18T
Titanium Micro Forceps Round Handle	0.7 mm Diamond Dust Insert	18 cm	BD-1340-18T
Titanium Micro Forceps Round Handle	0.8 mm Diamond Dust Insert	18 cm	BD-1341-18T
Titanium Micro Forceps Round Handle	0.3 mm Diamond Dust Insert	21 cm	BD-1338-21T
Titanium Micro Forceps Round Handle	0.4 mm Diamond Dust Insert	21 cm	BD-1339-21T
Titanium Micro Forceps Round Handle	0.7 mm Diamond Dust Insert	21 cm	BD-1340-21T
Titanium Micro Forceps Round Handle	0.8 mm Diamond Dust Insert	21 cm	BD-1341-21T

### Length

### Code



# MICRO FORCEPS

# MICRO FORCEPS

## Micro Forceps Round Handle



**Straight Gerade**  
0.3 mm

**Curved Gerade**  
0.3 mm

**Straight Gerade**  
0.4 mm

**Curved Gerade**  
0.4 mm

**Straight Gerade**  
0.7 mm

**Curved Gerade**  
0.7 mm

**Straight Gerade**  
0.8 mm

**Curved Gerade**  
0.8 mm



**Description**

**Length**

**Code**

Micro Forceps Round Handle	0.3 mm Diamond Dust Insert	15 cm	BD-1338-15
Micro Forceps Round Handle	0.4 mm Diamond Dust Insert	15 cm	BD-1339-15
Micro Forceps Round Handle	0.7 mm Diamond Dust Insert	15 cm	BD-1340-15
Micro Forceps Round Handle	0.8 mm Diamond Dust Insert	15 cm	BD-1341-15
Micro Forceps Round Handle	0.3 mm Diamond Dust Insert	18 cm	BD-1338-18
Micro Forceps Round Handle	0.4 mm Diamond Dust Insert	18 cm	BD-1339-18
Micro Forceps Round Handle	0.7 mm Diamond Dust Insert	18 cm	BD-1340-18
Micro Forceps Round Handle	0.8 mm Diamond Dust Insert	18 cm	BD-1341-18
Micro Forceps Round Handle	0.3 mm Diamond Dust Insert	21 cm	BD-1338-21
Micro Forceps Round Handle	0.4 mm Diamond Dust Insert	21 cm	BD-1339-21
Micro Forceps Round Handle	0.7 mm Diamond Dust Insert	21 cm	BD-1340-21
Micro Forceps Round Handle	0.8 mm Diamond Dust Insert	21 cm	BD-1341-21



### Titanium Micro DeBakey Forceps Round Handle Counterbalance



Straight Gerade  
1.0 mm



Curved Gerade  
1.0 mm



Straight Gerade  
1.3 mm



Curved Gerade  
1.3 mm



Straight Gerade  
1.5 mm



Curved Gerade  
1.5 mm



Description	Length	Code
Titanium Micro DeBakey Forceps Round Handle 1 mm	15 cm	BD-1350-15T
Titanium Micro DeBakey Forceps Round Handle 1.3 mm	15 cm	BD-1351-15T
Titanium Micro DeBakey Forceps Round Handle 1.5 mm	15 cm	BD-1352-15T
Titanium Micro DeBakey Forceps Round Handle 1 mm	18 cm	BD-1350-18T
Titanium Micro DeBakey Forceps Round Handle 1.3 mm	18 cm	BD-1351-18T
Titanium Micro DeBakey Forceps Round Handle 1.5 mm	18 cm	BD-1352-18T
Titanium Micro DeBakey Forceps Round Handle 1 mm	21 cm	BD-1350-21T
Titanium Micro DeBakey Forceps Round Handle 1.3 mm	21 cm	BD-1351-21T
Titanium Micro DeBakey Forceps Round Handle 1.5 mm	21 cm	BD-1352-21T
Titanium Micro DeBakey Forceps Round Handle 1 mm	23 cm	BD-1350-23T
Titanium Micro DeBakey Forceps Round Handle 1.3 mm	23 cm	BD-1351-23T
Titanium Micro DeBakey Forceps Round Handle 1.5 mm	23 cm	BD-1352-23T

### Micro DeBakey Forceps Round Handle Counterbalance



Straight Gerade  
1.0 mm



Curved Gerade  
1.0 mm



Straight Gerade  
1.3 mm



Curved Gerade  
1.3 mm



Straight Gerade  
1.5 mm



Curved Gerade  
1.5 mm



Description	Length	Code
Micro DeBakey Forceps Round Handle 1 mm	15 cm	BD-1350-15
Micro DeBakey Forceps Round Handle 1.3 mm	15 cm	BD-1351-15
Micro DeBakey Forceps Round Handle 1.5 mm	15 cm	BD-1352-15
Micro DeBakey Forceps Round Handle 1 mm	18 cm	BD-1350-18
Micro DeBakey Forceps Round Handle 1.3 mm	18 cm	BD-1351-18
Micro DeBakey Forceps Round Handle 1.5 mm	18 cm	BD-1352-18
Micro DeBakey Forceps Round Handle 1 mm	21 cm	BD-1350-21
Micro DeBakey Forceps Round Handle 1.3 mm	21 cm	BD-1351-21
Micro DeBakey Forceps Round Handle 1.5 mm	21 cm	BD-1352-21
Micro DeBakey Forceps Round Handle 1 mm	23 cm	BD-1350-23
Micro DeBakey Forceps Round Handle 1.3 mm	23 cm	BD-1351-23
Micro DeBakey Forceps Round Handle 1.5 mm	23 cm	BD-1352-23

# MICRO FORCEPS

## Titanium Micro DeBakey Forceps Round Handle



**Straight Gerade**  
1.0 mm



**Curved Gerade**  
1.0 mm



**Straight Gerade**  
1.3 mm



**Curved Gerade**  
1.3 mm



**Straight Gerade**  
1.5 mm



**Curved Gerade**  
1.5 mm



Description		Length	Code
Titanium Micro DeBakey Forceps Round Handle	1 mm	15 cm	BD-1353-15T
Titanium Micro DeBakey Forceps Round Handle	1.3 mm	15 cm	BD-1354-15T
Titanium Micro DeBakey Forceps Round Handle	1.5 mm	15 cm	BD-1355-15T
Titanium Micro DeBakey Forceps Round Handle	1 mm	18 cm	BD-1353-18T
Titanium Micro DeBakey Forceps Round Handle	1.3 mm	18 cm	BD-1354-18T
Titanium Micro DeBakey Forceps Round Handle	1.5 mm	18 cm	BD-1355-18T
Titanium Micro DeBakey Forceps Round Handle	1 mm	21 cm	BD-1353-21T
Titanium Micro DeBakey Forceps Round Handle	1.3 mm	21 cm	BD-1354-21T
Titanium Micro DeBakey Forceps Round Handle	1.5 mm	21 cm	BD-1355-21T
Titanium Micro DeBakey Forceps Round Handle	1 mm	23 cm	BD-1353-23T
Titanium Micro DeBakey Forceps Round Handle	1.3 mm	23 cm	BD-1354-23T
Titanium Micro DeBakey Forceps Round Handle	1.5 mm	23 cm	BD-1355-23T

## Micro DeBakey Forceps Round Handle



**Straight Gerade**  
1.0 mm



**Curved Gerade**  
1.0 mm



**Straight Gerade**  
1.3 mm



**Curved Gerade**  
1.3 mm



**Straight Gerade**  
1.5 mm



**Curved Gerade**  
1.5 mm



Description		Length	Code
Micro DeBakey Forceps Round Handle	1 mm	15 cm	BD-1353-15
Micro DeBakey Forceps Round Handle	1.3 mm	15 cm	BD-1354-15
Micro DeBakey Forceps Round Handle	1.5 mm	15 cm	BD-1355-15
Micro DeBakey Forceps Round Handle	1 mm	18 cm	BD-1353-18
Micro DeBakey Forceps Round Handle	1.3 mm	18 cm	BD-1354-18
Micro DeBakey Forceps Round Handle	1.5 mm	18 cm	BD-1355-18
Micro DeBakey Forceps Round Handle	1 mm	21 cm	BD-1353-21
Micro DeBakey Forceps Round Handle	1.3 mm	21 cm	BD-1354-21
Micro DeBakey Forceps Round Handle	1.5 mm	21 cm	BD-1355-21
Micro DeBakey Forceps Round Handle	1 mm	23 cm	BD-1353-23
Micro DeBakey Forceps Round Handle	1.3 mm	23 cm	BD-1354-23
Micro DeBakey Forceps Round Handle	1.5 mm	23 cm	BD-1355-23

### Titanium Gerald DeBakey Forceps Flat Handle



**Description**

Titanium Gerald DeBakey Forceps Flat Handle	1 mm Jaw
Titanium Gerald DeBakey Forceps Flat Handle	1 mm Jaw
Titanium Gerald DeBakey Forceps Flat Handle	1 mm Jaw

**Length**

18 cm
21 cm
23 cm

**Code**

BD-009-18T
BD-009-21T
BD-009-23T

### Gerald DeBakey Forceps Flat Handle



**Description**

Gerald DeBakey Forceps Flat Handle	1 mm Jaw
Gerald DeBakey Forceps Flat Handle	1 mm Jaw
Gerald DeBakey Forceps Flat Handle	1 mm Jaw

**Length**

18 cm
21 cm
23 cm

**Code**

BD-009-18
BD-009-21
BD-009-23

### Titanium Gerald Forceps Flat Handle



**Description**

Titanium Gerald Forceps	1 mm Jaw Flat Handle
Titanium Gerald Forceps	1 mm Jaw Flat Handle
Titanium Gerald Forceps	1 mm Jaw Flat Handle

**Length**

18 cm
21 cm
23 cm

**Code**

BD-007-18T
BD-007-21T
BD-007-23T

**Gerald Forceps Flat Handle**

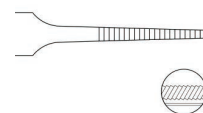

**Description**

Gerald Forceps 1 mm Jaw Flat Handle  
 Gerald Forceps 1 mm Jaw Flat Handle  
 Gerald Forceps 1 mm Jaw Flat Handle

**Length**

18 cm  
 21 cm  
 23 cm

**Code**

BD-007-18  
 BD-007-21  
 BD-007-23

**Titanium Gerald Ring Forceps Flat Handle**

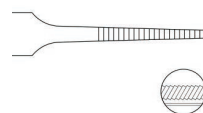

**Description**

Titanium Gerald Ring Forceps 1 x 0.5 mm Flat Handle  
 Titanium Gerald Ring Forceps 1 x 0.5 mm Flat Handle

**Length**

18 cm  
 21 cm

**Code**

BD-010-18T  
 BD-010-21T



### Gerald Ring Forceps Flat Handle



Straight  
1 x 0.5 mm



Curved  
1 x 0.5 mm



**Description**

Gerald Ring Forceps 1 x 0.5 mm Flat Handle  
Gerald Ring Forceps 1 x 0.5 mm Flat Handle

**Length**

18 cm  
21 cm

**Code**

BD-010-18  
BD-010-21

### Gerald Forceps Straight TC



**Description**

Gerald Forceps Straight TC  
Gerald Forceps Straight TC

**Length**

18 cm  
23 cm

**Code**

BD-070-18  
BD-070-23

### Resano Forceps Multi Toothed



**Description**

Resano Forceps Multi Toothed  
Resano Forceps Multi Toothed  
Resano Forceps Multi Toothed  
Resano Forceps Multi Toothed

**Length**

18 cm  
20 cm  
23 cm  
30 cm

**Code**

BD-190-18  
BD-190-20  
BD-190-23  
BD-190-30

**Adson Brown Forceps**



**Description**

Adson Brown Forceps 7 x 7 toothed  
 Adson Brown Forceps 7 x 7 toothed

**Length**

12 cm  
 15 cm

**Code**

BD-191-12  
 BD-191-15

**Micro Adson Forceps Plain**

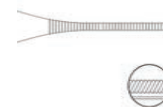

**Description**

Micro Adson Forceps Plain  
 Micro Adson Forceps Plain

**Length**

12 cm  
 15 cm

**Code**

BD-044-12  
 BD-044-15

**Micro Adson Forceps Toothed**

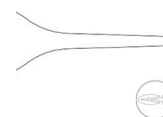

**Description**

Micro Adson Forceps Toothed  
 Micro Adson Forceps Toothed

**Length**

12 cm  
 15 cm

**Code**

BD-043-12  
 BD-043-15

**Micro Adson Forceps Toothed with Hole**

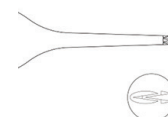

**Description**

Micro Adson Forceps Toothed with Hole  
 Micro Adson Forceps Toothed with Hole

**Length**

12 cm  
 15 cm

**Code**

BD-045-12  
 BD-045-15

**Adson Forceps Plain**

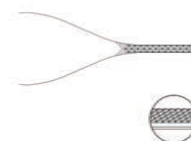

**Description**

Adson Forceps Plain  
 Adson Forceps Plain

**Length**

12 cm  
 15 cm

**Code**

BD-042-12  
 BD-042-15

**Adson Forceps Toothed**



**Description**

Adson Forceps Toothed  
 Adson Forceps Toothed

**Length**

12 cm  
 15 cm

**Code**

BD-041-12  
 BD-041-15

**Titanium Adson Forceps Plain**

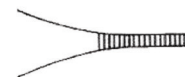

**Description**

Titanium Adson Forceps Plain  
 Titanium Adson Forceps Plain

**Length**

12 cm  
 15 cm

**Code**

BD-042-12T  
 BD-042-15T

**Titanium Adson Forceps Toothed**



**Description**

Titanium Adson Forceps Toothed  
 Titanium Adson Forceps Toothed

**Length**

12 cm  
 15 cm

**Code**

BD-043-12T  
 BD-043-15T

**Bonneys Forceps Toothed 18 cm**

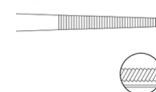

**Description**

Bonneys Forceps Toothed

**Length**

18 cm

**Code**

BD-175-18

**Gillies Forceps Toothed 15 cm**



**Description**

Gillies Forceps Toothed

**Length**

15 cm

**Code**

BD-152-15

**Titanium Gillies Forceps Toothed 15 cm**



1 x 2

**Description**

Titanium Gillies Forceps Toothed

**Length**

15 cm

**Code**

BD-152-15T

**McIndoe Forceps Plain 15 cm**



**Description**

McIndoe Forceps Plain

**Length**

15 cm

**Code**

BD-050-15

# MICRO FORCEPS

## Titanium McIndoe Forceps Plain 15 cm

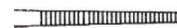

Description	Length	Code
Titanium McIndoe Forceps Plain	15 cm	BD-050-15T

## Russian Forceps



Description	Length	Code
Russian Forceps	15 cm	BD-084-15
Russian Forceps	20 cm	BD-084-20
Russian Forceps	25 cm	BD-084-25
Russian Forceps	30 cm	BD-084-30



### Treves Forceps Toothed 15 cm



1 x 2



**Description**

Treves Forceps Toothed

**Length**

15 cm

**Code**

BD-180-15

### DeBakey Vascular Forceps



Angled DeBakey Forceps



1.5 mm



2 mm



2.4 mm



2.8 mm

**Description**

DeBakey Vascular Forceps	1.5 mm Tip
DeBakey Vascular Forceps	1.5 mm Tip
DeBakey Vascular Forceps	1.5 mm Tip
DeBakey Vascular Forceps	1.5 mm Tip
DeBakey Vascular Forceps	2 mm Tip
DeBakey Vascular Forceps	2 mm Tip
DeBakey Vascular Forceps	2 mm Tip
DeBakey Vascular Forceps	2 mm Tip
DeBakey Vascular Forceps	2.4 mm Tip
DeBakey Vascular Forceps	2.4 mm Tip
DeBakey Vascular Forceps	2.4 mm Tip
DeBakey Vascular Forceps	2.4 mm Tip
DeBakey Vascular Forceps	2.8 mm Tip
DeBakey Vascular Forceps	2.8 mm Tip
DeBakey Vascular Forceps	2.8 mm Tip
DeBakey Vascular Forceps	2.8 mm Tip

**Length**

16 cm
20 cm
24 cm
30 cm
16 cm
20 cm
24 cm
30 cm
16 cm
20 cm
24 cm
30 cm
16 cm
20 cm
24 cm
30 cm

**Code**

BD-210-16
BD-210-20
BD-210-24
BD-210-30
BD-208-16
BD-208-20
BD-208-24
BD-208-30
BD-206-16
BD-206-20
BD-206-24
BD-206-30
BD-204-16
BD-204-20
BD-204-24
BD-204-30

**Titanium DeBakey Vascular Forceps**



**Angled DeBakey Forceps**



**1.5 mm**



**2 mm**



**2.4 mm**



**2.8 mm**

**Description**

Titanium DeBakey Vascular Forceps 1.5 mm Tip  
 Titanium DeBakey Vascular Forceps 1.5 mm Tip  
 Titanium DeBakey Vascular Forceps 1.5 mm Tip  
 Titanium DeBakey Vascular Forceps 1.5 mm Tip  
 Titanium DeBakey Vascular Forceps 2 mm Tip  
 Titanium DeBakey Vascular Forceps 2 mm Tip  
 Titanium DeBakey Vascular Forceps 2 mm Tip  
 Titanium DeBakey Vascular Forceps 2 mm Tip  
 Titanium DeBakey Vascular Forceps 2.4 mm Tip  
 Titanium DeBakey Vascular Forceps 2.4 mm Tip  
 Titanium DeBakey Vascular Forceps 2.4 mm Tip  
 Titanium DeBakey Vascular Forceps 2.4 mm Tip  
 Titanium DeBakey Vascular Forceps 2.8 mm Tip  
 Titanium DeBakey Vascular Forceps 2.8 mm Tip  
 Titanium DeBakey Vascular Forceps 2.8 mm Tip  
 Titanium DeBakey Vascular Forceps 2.8 mm Tip

1.5 mm Tip  
 1.5 mm Tip  
 1.5 mm Tip  
 1.5 mm Tip  
 2 mm Tip  
 2 mm Tip  
 2 mm Tip  
 2 mm Tip  
 2.4 mm Tip  
 2.4 mm Tip  
 2.4 mm Tip  
 2.4 mm Tip  
 2.8 mm Tip  
 2.8 mm Tip  
 2.8 mm Tip  
 2.8 mm Tip

**Length**

16 cm  
 20 cm  
 24 cm  
 30 cm  
 16 cm  
 20 cm  
 24 cm  
 30 cm  
 16 cm  
 20 cm  
 24 cm  
 30 cm  
 16 cm  
 20 cm  
 24 cm  
 30 cm

**Code**

BD-210-16T  
 BD-210-20T  
 BD-210-24T  
 BD-210-30T  
 BD-208-16T  
 BD-208-20T  
 BD-208-24T  
 BD-208-30T  
 BD-206-16T  
 BD-206-20T  
 BD-206-24T  
 BD-206-30T  
 BD-204-16T  
 BD-204-20T  
 BD-204-24T  
 BD-204-30T

**Cushing Forceps TC Straight**



**Description**

Cushing Forceps TC Straight

**Length**

18 cm

**Code**

BD-1818-18

# SKILL<sup>®</sup>

Surgical Instruments

## MICRO NEEDLE HOLDERS

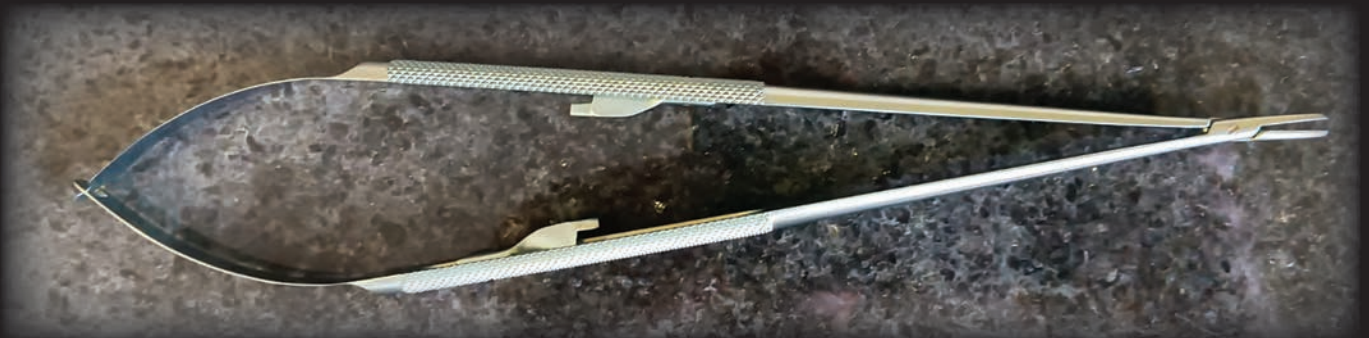

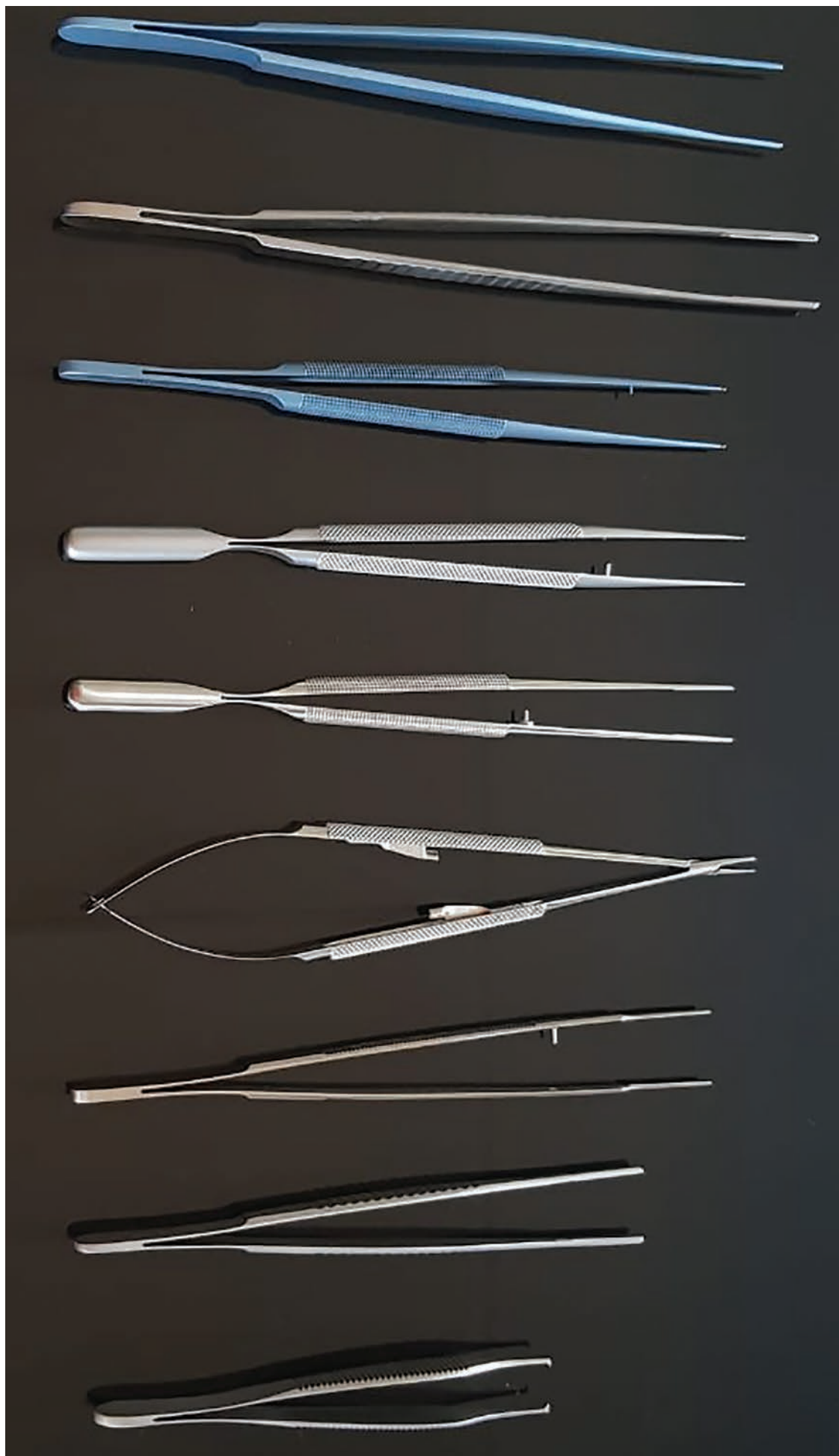

# Index

## Micro Needle Holder

Titanium Jacobson Micro Needle Holder Round Handle 0.8 mm Jaw	137
Titanium Jacobson Micro Needle Holder Round Handle 1 mm Jaw	138
Titanium Jacobson Micro Needle Holder Round Handle 1.2 mm Jaw   1.5 mm Jaw	139
Titanium Micro Needle Holder Flat Handle 0.8 mm Jaw	140
Titanium Micro Needle Holder Flat Handle 1 mm Jaw	141
Titanium Micro Needle Holder Flat Handle 1.2 mm Jaw	142
Titanium Micro Needle Holder Flat Handle 1.5 mm Jaw	143
Titanium Micro Needle Holder Diamond Dust Flat Handle 2 mm Jaw	144
Jacobson Micro Needle Holder Diamond Dust Round Handle 0.8 mm Jaw	145
Jacobson Micro Needle Holder Diamond Dust Round Handle 1 mm Jaw	146
Jacobson Micro Needle Holder Diamond Dust Round Handle 1.2 mm Jaw	147
Jacobson Micro Needle Holder Diamond Dust Round Handle 1.5 mm Jaw	148
Micro Needle Holder Diamond Dust Flat Handle 1 mm Jaw   1.2 mm Jaw	149
Micro Needle Holder Diamond Dust Flat Handle 1.5 mm Jaw   2 mm Jaw	150
Yasargil Micro Needle Holder Diamond Dust Flat Handle 0.8 mm Jaw   1.2 mm Jaw	151
Castroviejo Micro Needle Holder Flat Handle TC 0.8 mm Jaw	152
Castroviejo Micro Needle Holders Flat Handle TC 1 mm Jaw	153
Castroviejo Micro Needle Holder Flat Handle TC 1.2 mm Jaw	154
Castroviejo Micro Needle Holders Flat Handle TC 1.5 mm Jaw	155
Jacobson Micro Needle Holder Round Handle TC 1 mm Jaw	156
Jacobson Micro Needle Holder Round Handle TC 1.2 mm Jaw	157
Heavy Jacobson Round Handle Needle Holder TC 2 mm Jaw	158
Heavy Jacobson Round Handle Needle Holder Diamond Dusted 2 mm Jaw	159
Heavy Jacobson Round Handle Needle Holder Diamond Dusted 2.5 mm Jaw	159
Titanium Heavy Jacobson Round Handle Needle Holder Diamond Dusted 2 mm Jaw	160
Titanium Heavy Jacobson Round Handle Needle Holder Diamond Dusted 2.5 mm Jaw	160
Ryder-Vascular Needle Holder TC	161
Halsey Needle Holder TC	161
Micro-Vascular Needle Holder TC	162
DeBakey Needle Holder TC	163
Micro Ryder-Vascular Needle Holder TC	164
Mayo Hegar Needle Holder TC	165
Crile-Wood Needle Holder TC	166
Neivert Needle Holder TC	166
Baumgartner Wire Forceps	167
Wire Forceps TC Rounded	167
Wire Forceps TC Square Jaw	168
Wire Forceps Serrated Jaw	169
Wire Cutter TC	169-170

# MICRO NEEDLE HOLDER

**SKILL Micro Needle Holders are set for grasping needles without rotation. Enhanced Needle Grip Surface by placing a needle at the very tip and then slightly pushing or pulling it or by holding the closed tip up against the light.**



## Diamond Dust Inserts



**0.8 mm Diamond Dusted Jaw  
Suture 8-0 and smaller**

**1 mm Diamond Dusted Jaw  
Suture 5-0 and smaller**

**1.2 mm Diamond Dusted Jaw  
Suture 5-0 and smaller**

**1.5 mm Diamond Dusted Jaw  
Suture 5-0 and smaller**

**2 mm Diamond Dusted Jaw  
Suture 2-0 and smaller**

## Tungsten Carbide Inserts



**0.8 mm w Inserts Jaw  
Suture 8-0 and smaller**

**1 mm TC Inserts Jaw  
Suture 5-0 and smaller**

**1.2 mm TC Inserts Jaw  
Suture 5-0 and smaller**

**1.5 mm TC Inserts Jaw  
Suture 5-0 and smaller**

**2 mm TC Inserts Jaw  
Suture 4-0 and smaller**

**2.5 mm TC Inserts Jaw  
Suture 4-0 and smaller**

**Titanium Jacobson Micro Needle Holder Round Handle 0.8 mm Jaw**



0.8 mm Diamond Dusted Jaw  
Suture 8-0 and smaller



Diamond  
Dust Inserts

**Description**

Titanium Jacobson Micro Needle Holder Straight Jaw w/catch  
 Titanium Jacobson Micro Needle Holder Curved Jaw w/catch  
 Titanium Jacobson Micro Needle Holder Straight Jaw w/catch  
 Titanium Jacobson Micro Needle Holder Curved Jaw w/catch  
 Titanium Jacobson Micro Needle Holder Straight Jaw w/catch  
 Titanium Jacobson Micro Needle Holder Curved Jaw w/catch  
 Titanium Jacobson Micro Needle Holder Straight Jaw w/catch  
 Titanium Jacobson Micro Needle Holder Curved Jaw w/catch

**Length**

18 cm  
18 cm  
21 cm  
21 cm  
23 cm  
23 cm  
25 cm  
25 cm

**Code**

BI-1300-18T  
BI-1301-18T  
BI-1300-21T  
BI-1301-21T  
BI-1300-23T  
BI-1301-23T  
BI-1300-25T  
BI-1301-25T



**MICRO NEEDLE HOLDER**

# MICRO NEEDLE HOLDER

## Titanium Jacobson Micro Needle Holder Round Handle 1 mm Jaw

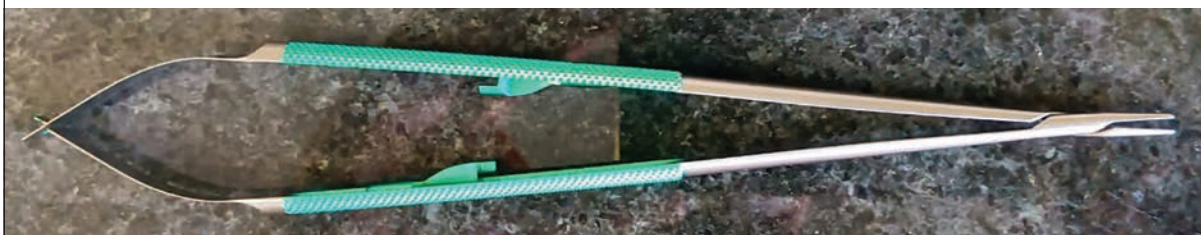

1 mm Diamond Dusted Jaw  
Suture 5-0 and smaller



Diamond  
Dust Inserts

Description	Length	Code
Titanium Jacobson MicWro Needle Holder Straight Jaw w/catch	18 cm	BI-1302-18T
Titanium Jacobson Micro Needle Holder Curved Jaw w/catch	18 cm	BI-1303-18T
Titanium Jacobson Micro Needle Holder Straight Jaw w/catch	21 cm	BI-1302-21T
Titanium Jacobson Micro Needle Holder Curved Jaw w/catch	21 cm	BI-1303-21T
Titanium Jacobson Micro Needle Holder Straight Jaw w/catch	23 cm	BI-1302-23T
Titanium Jacobson Micro Needle Holder Curved Jaw w/catch	23 cm	BI-1303-23T
Titanium Jacobson Micro Needle Holder Straight Jaw w/catch	25 cm	BI-1302-25T
Titanium Jacobson Micro Needle Holder Curved Jaw w/catch	25 cm	BI-1303-25T



**Titanium Jacobson Micro Needle Holder Round Handle 1.2 mm Jaw**

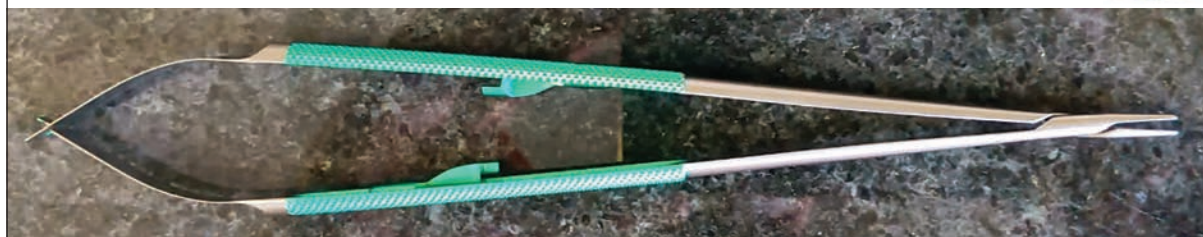

1.2 mm Diamond Dusted Jaw  
Suture 5-0 and smaller



Diamond  
Dust Inserts

Description	Length	Code
Titanium Jacobson Micro Needle Holder Straight Jaw w/catch	18 cm	BI-1305-18T
Titanium Jacobson Micro Needle Holder Curved Jaw w/catch	18 cm	BI-1304-18T
Titanium Jacobson Micro Needle Holder Straight Jaw w/catch	21 cm	BI-1305-21T
Titanium Jacobson Micro Needle Holder Curved Jaw w/catch	21 cm	BI-1304-21T
Titanium Jacobson Micro Needle Holder Straight Jaw w/catch	23 cm	BI-1305-23T
Titanium Jacobson Micro Needle Holder Curved Jaw w/catch	23 cm	BI-1304-23T
Titanium Jacobson Micro Needle Holder Straight Jaw w/catch	25 cm	BI-1305-25T
Titanium Jacobson Micro Needle Holder Curved Jaw w/catch	25 cm	BI-1304-25T

**Titanium Jacobson Micro Needle Holder Round Handle 1.5 mm Jaw**



1.5 mm Diamond Dusted Jaw  
Suture 5-0 and smaller



Diamond  
Dust Inserts

Description	Length	Code
Titanium Jacobson Micro Needle Holder Straight Jaw w/catch	18 cm	BI-1306-18T
Titanium Jacobson Micro Needle Holder Curved Jaw w/catch	18 cm	BI-1307-18T
Titanium Jacobson Micro Needle Holder Straight Jaw w/catch	21 cm	BI-1306-21T
Titanium Jacobson Micro Needle Holder Curved Jaw w/catch	21 cm	BI-1307-21T
Titanium Jacobson Micro Needle Holder Straight Jaw w/catch	23 cm	BI-1306-23T
Titanium Jacobson Micro Needle Holder Curved Jaw w/catch	23 cm	BI-1307-23T
Titanium Jacobson Micro Needle Holder Straight Jaw w/catch	25 cm	BI-1306-25T
Titanium Jacobson Micro Needle Holder Curved Jaw w/catch	25 cm	BI-1307-25T

# MICRO NEEDLE HOLDER

## Titanium Micro Needle Holder Flat Handle 0.8 mm Jaw



0.8 mm Diamond Dusted Jaw  
Suture 8-0 and smaller



Diamond  
Dust Inserts

Description	Length	Code
Titanium Micro Needle Holder Straight Jaw w/catch	18 cm	BI-1309-18T
Titanium Micro Needle Holder Curved Jaw w/catch	18 cm	BI-1310-18T
Titanium Micro Needle Holder Straight Jaw w/catch	21 cm	BI-1309-21T
Titanium Micro Needle Holder Curved Jaw w/catch	21 cm	BI-1310-21T
Titanium Micro Needle Holder Straight Jaw w/catch	23 cm	BI-1309-23T
Titanium Micro Needle Holder Curved Jaw w/catch	23 cm	BI-1310-23T



**Titanium Micro Needle Holder Flat Handle 1 mm Jaw**



1 mm Diamond Dusted Jaw  
Suture 5-0 and smaller



Diamond  
Dust Inserts

Description	Length	Code
Titanium Micro Needle Holder Straight Jaw w/catch	18 cm	BI-1317-18T
Titanium Micro Needle Holder Curved Jaw w/catch	18 cm	BI-1318-18T
Titanium Micro Needle Holder Straight Jaw w/catch	21 cm	BI-1317-21T
Titanium Micro Needle Holder Curved Jaw w/catch	21 cm	BI-1318-21T
Titanium Micro Needle Holder Straight Jaw w/catch	23 cm	BI-1317-23T
Titanium Micro Needle Holder Curved Jaw w/catch	23 cm	BI-1318-23T



**MICRO NEEDLE HOLDER**

# MICRO NEEDLE HOLDER

## Titanium Micro Needle Holder Flat Handle 1.2 mm Jaw



1.2 mm Diamond Dusted Jaw  
Suture 5-0 and smaller



Diamond  
Dust Inserts

Description	Length	Code
Titanium Needle Holder Straight Jaw w/catch	18 cm	BI-1311-18T
Titanium Needle Holder Curved Jaw w/catch	18 cm	BI-1312-18T
Titanium Needle Holder Straight Jaw w/catch	21 cm	BI-1311-21T
Titanium Needle Holder Curved Jaw w/catch	21 cm	BI-1312-21T
Titanium Needle Holder Straight Jaw w/catch	23 cm	BI-1311-23T
Titanium Needle Holder Curved Jaw w/catch	23 cm	BI-1312-23T



**Titanium Micro Needle Holder Flat Handle 1.5 mm Jaw**



1.5 mm Diamond Dusted Jaw  
Suture 5-0 and smaller



Diamond  
Dust Inserts

**Description**

- Titanium Needle Holder Straight Jaw w/catch
- Titanium Needle Holder Curved Jaw w/catch
- Titanium Needle Holder Straight Jaw w/catch
- Titanium Needle Holder Curved Jaw w/catch
- Titanium Needle Holder Straight Jaw w/catch
- Titanium Needle Holder Curved Jaw w/catch

**Length**

- 18 cm
- 18 cm
- 21 cm
- 21 cm
- 23 cm
- 23 cm

**Code**

- BI-1313-18T
- BI-1314-18T
- BI-1313-21T
- BI-1314-21T
- BI-1313-23T
- BI-1314-23T



**MICRO NEEDLE HOLDER**

# MICRO NEEDLE HOLDER

## Titanium Micro Needle Holder Diamond Dust Flat Handle 2 mm Jaw



2 mm Diamond Dusted Jaw  
Suture 2-0 and smaller



Diamond  
Dust Inserts

Description	Length	Code
Titanium Needle Holder Straight Jaw w/catch	18 cm	BI-1315-18T
Titanium Needle Holder Curved Jaw w/catch	18 cm	BI-1316-18T
Titanium Needle Holder Straight Jaw w/catch	23 cm	BI-1315-23T
Titanium Needle Holder Curved Jaw w/catch	23 cm	BI-1316-23T
Titanium Needle Holder Straight Jaw w/catch	25 cm	BI-1315-25T
Titanium Needle Holder Curved Jaw w/catch	25 cm	BI-1316-25T



**Jacobson Micro Needle Holder Diamond Dust Round Handle 0.8 mm Jaw**



0.8 mm Diamond Dusted Jaw  
Suture 8-0 and smaller



Diamond  
Dust Inserts

Description	Length	Code
Jacobson Micro Needle Holder Straight Jaw w/catch	16 cm	BI-1201-16
Jacobson Micro Needle Holder Curved Jaw w/catch	16 cm	BI-1202-16
Jacobson Micro Needle Holder Straight Jaw w/catch	18 cm	BI-1201-18
Jacobson Micro Needle Holder Curved Jaw w/catch	18 cm	BI-1202-18



**MICRO NEEDLE HOLDER**

**Jacobson Micro Needle Holder Diamond Dust Round Handle 1 mm Jaw**



1 mm Diamond Dusted Jaw  
Suture 5-0 and smaller



Diamond  
Dust Inserts

Description	Length	Code
Jacobson Micro Needle Holder Straight Jaw w/catch	18 cm	BI-1210-18
Jacobson Micro Needle Holder Curved Jaw w/catch	18 cm	BI-1211-18
Jacobson Micro Needle Holder Straight Jaw w/catch	21 cm	BI-1210-21
Jacobson Micro Needle Holder Curved Jaw w/catch	21 cm	BI-1211-21
Jacobson Micro Needle Holder Straight Jaw w/catch	23 cm	BI-1210-23
Jacobson Micro Needle Holder Curved Jaw w/catch	23 cm	BI-1211-23
Jacobson Micro Needle Holder Straight Jaw w/catch	25 cm	BI-1210-25
Jacobson Micro Needle Holder Curved Jaw w/catch	25 cm	BI-1211-25

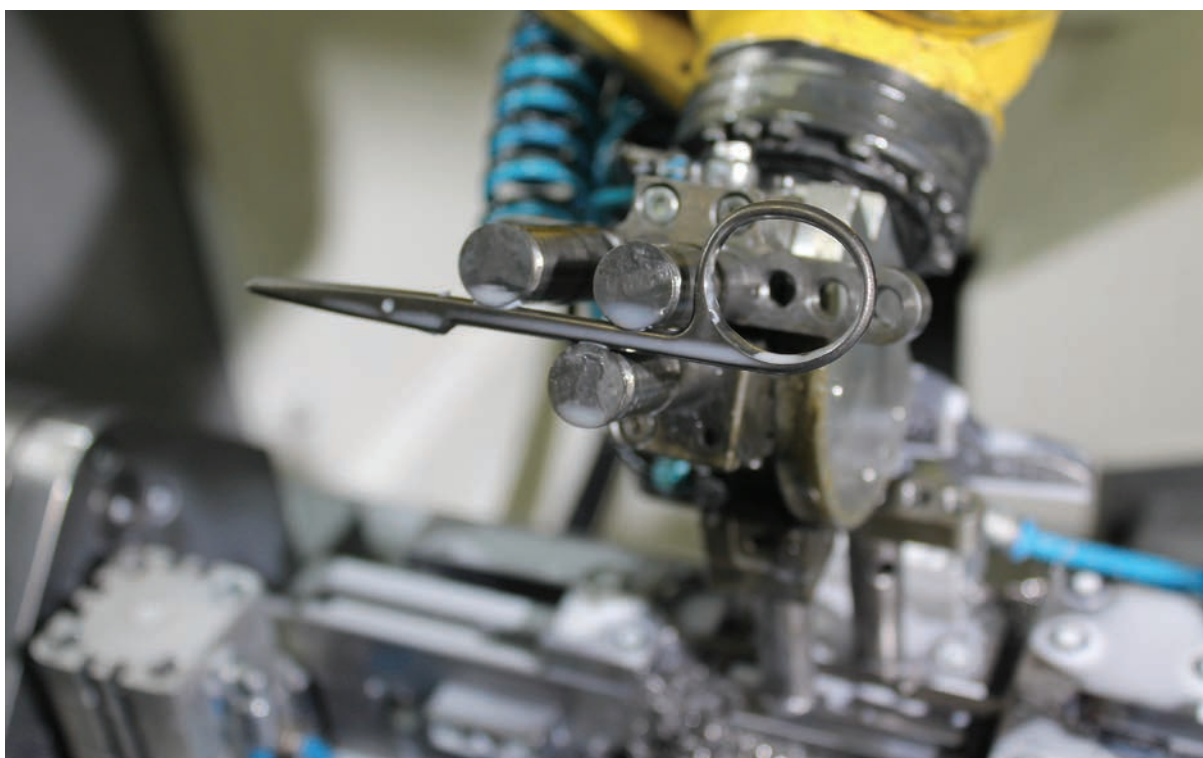

**Jacobson Micro Needle Holder Diamond Dust Round Handle 1.2 mm Jaw**



1.2 mm Diamond Dusted Jaw  
Suture 5-0 and smaller



Diamond  
Dust Inserts

**Description**

- Jacobson Micro Needle Holder Straight Jaw w/catch
- Jacobson Micro Needle Holder Curved Jaw w/catch
- Jacobson Micro Needle Holder Straight Jaw w/catch
- Jacobson Micro Needle Holder Curved Jaw w/catch
- Jacobson Micro Needle Holder Straight Jaw w/catch
- Jacobson Micro Needle Holder Curved Jaw w/catch
- Jacobson Micro Needle Holder Straight Jaw w/catch
- Jacobson Micro Needle Holder Curved Jaw w/catch

**Length**

- 18 cm
- 18 cm
- 21 cm
- 21 cm
- 23 cm
- 23 cm
- 25 cm
- 25 cm

**Code**

- BI-1212-18
- BI-1213-18
- BI-1212-21
- BI-1213-21
- BI-1212-23
- BI-1213-23
- BI-1212-25
- BI-1213-25



**MICRO NEEDLE HOLDER**

# MICRO NEEDLE HOLDER

## Jacobson Micro Needle Holder Diamond Dust Round Handle 1.5 mm Jaw



1.5 mm Diamond Dusted Jaw  
Suture 5-0 and smaller



Diamond  
Dust Inserts

Description	Length	Code
Jacobson Micro Needle Holder Straight Jaw w/catch	18 cm	BI-1208-18
Jacobson Micro Needle Holder Curved Jaw w/catch	18 cm	BI-1209-18
Jacobson Micro Needle Holder Straight Jaw w/catch	21 cm	BI-1208-21
Jacobson Micro Needle Holder Curved Jaw w/catch	21 cm	BI-1209-21
Jacobson Micro Needle Holder Straight Jaw w/catch	23 cm	BI-1208-23
Jacobson Micro Needle Holder Curved Jaw w/catch	23 cm	BI-1209-23
Jacobson Micro Needle Holder Straight Jaw w/catch	25 cm	BI-1208-25
Jacobson Micro Needle Holder Curved Jaw w/catch	25 cm	BI-1209-25



### Micro Needle Holder Diamond Dust Flat Handle 1 mm Jaw



1 mm Diamond Dusted Jaw  
Suture 5-0 and smaller



Diamond  
Dust Inserts

Description	Length	Code
Micro Needle Holder Straight Jaw w/catch	18 cm	BI-1214-18
Micro Needle Holder Curved Jaw w/catch	18 cm	BI-1215-18
Micro Needle Holder Straight Jaw w/catch	23 cm	BI-1214-23
Micro Needle Holder Curved Jaw w/catch	23 cm	BI-1215-23
Micro Needle Holder Straight Jaw w/catch	25 cm	BI-1214-25
Micro Needle Holder Curved Jaw w/catch	25 cm	BI-1215-25

### Micro Needle Holder Diamond Dust Flat Handle 1.2 mm Jaw



1.2 mm Diamond Dusted Jaw  
Suture 5-0 and smaller



Diamond  
Dust Inserts

Description	Length	Code
Micro Needle Holder Straight Jaw w/catch	18 cm	BI-1218-18
Micro Needle Holder Curved Jaw w/catch	18 cm	BI-1219-18
Micro Needle Holder Straight Jaw w/catch	21 cm	BI-1218-21
Micro Needle Holder Curved Jaw w/catch	21 cm	BI-1219-21
Micro Needle Holder Straight Jaw w/catch	23 cm	BI-1218-23
Micro Needle Holder Curved Jaw w/catch	23 cm	BI-1219-23

**Micro Needle Holder Diamond Dust Flat Handle 1.5 mm Jaw**



1.5 mm Diamond Dusted Jaw  
Suture 5-0 and smaller



Diamond  
Dust Inserts

Description	Length	Code
Micro Needle Holder Straight Jaw w/catch	18 cm	BI-1216-18
Micro Needle Holder Curved Jaw w/catch	18 cm	BI-1217-18
Micro Needle Holder Straight Jaw w/catch	23 cm	BI-1216-23
Micro Needle Holder Curved Jaw w/catch	23 cm	BI-1217-23
Micro Needle Holder Straight Jaw w/catch	25 cm	BI-1216-25
Micro Needle Holder Curved Jaw w/catch	25 cm	BI-1217-25

**Micro Needle Holder Diamond Dust Flat Handle 2 mm Jaw**



2 mm Diamond Dusted Jaw  
Suture 2-0 and smaller



Diamond  
Dust Inserts

Description	Length	Code
Micro Needle Holder Straight Jaw w/catch	28 cm	BI-1220-28
Micro Needle Holder Curved Jaw w/catch	28 cm	BI-1221-28
Micro Needle Holder Straight Jaw w/catch	30 cm	BI-1220-30
Micro Needle Holder Curved Jaw w/catch	30 cm	BI-1221-30
Micro Needle Holder Straight Jaw w/catch	32 cm	BI-1220-32
Micro Needle Holder Curved Jaw w/catch	32cm	BI-1221-32

**Yasargil Micro Needle Holder Diamond Dust Flat Handle 0.8 mm Jaw**



0.8 mm Diamond Dusted Jaw  
Suture 8-0 and smaller



Diamond  
Dust Inserts

**Description**

- Yasargil Needle Holder Straight Jaw w/catch
- Yasargil Needle Holder Curved Jaw w/catch
- Yasargil Needle Holder Straight Jaw w/catch
- Yasargil Needle Holder Curved Jaw w/catch
- Yasargil Needle Holder Straight Jaw w/catch
- Yasargil Needle Holder Curved Jaw w/catch

**Length**

- 18 cm
- 18 cm
- 21 cm
- 21 cm
- 23 cm
- 23 cm

**Code**

- BI-1222-18
- BI-1223-18
- BI-1222-21
- BI-1223-21
- BI-1222-23
- BI-1223-23

**Yasargil Micro Needle Holder Diamond Dust Flat Handle 1.2 mm Jaw**



1.2 mm Diamond Dusted Jaw  
Suture 5-0 and smaller



Diamond  
Dust Inserts

**Description**

- Yasargil Needle Holder Straight Jaw w/catch
- Yasargil Needle Holder Curved Jaw w/catch
- Yasargil Needle Holder Straight Jaw w/catch
- Yasargil Needle Holder Curved Jaw w/catch
- Yasargil Needle Holder Straight Jaw w/catch
- Yasargil Needle Holder Curved Jaw w/catch

**Length**

- 18 cm
- 18 cm
- 21 cm
- 21 cm
- 23 cm
- 23 cm

**Code**

- BI-1224-18
- BI-1225-18
- BI-1224-21
- BI-1225-21
- BI-1224-23
- BI-1225-23

# MICRO NEEDLE HOLDER

## Castroviejo Micro Needle Holder Flat Handle TC 0.8 mm Jaw



0.8 mm TC Inserts Jaw  
Suture 8-0 and smaller



Tungsten  
Carbide Inserts

Description	Length	Code
Castroviejo Micro Needle Holder Straight Flat Handle TC w/catch	18 cm	BI-1226-18
Castroviejo Micro Needle Holder Curved Flat Handle TC w/catch	18 cm	BI-1227-18
Castroviejo Micro Needle Holder Straight Flat Handle TC w/catch	21 cm	BI-1226-21
Castroviejo Micro Needle Holder Curved Flat Handle TC w/catch	21 cm	BI-1227-21
Castroviejo Micro Needle Holder Straight Flat Handle TC w/catch	23 cm	BI-1226-23
Castroviejo Micro Needle Holder Curved Flat Handle TC w/catch	23 cm	BI-1227-23

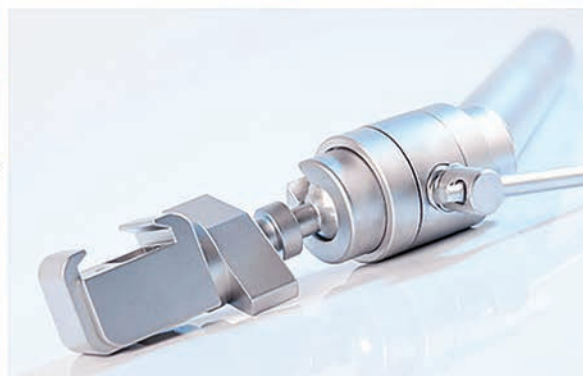
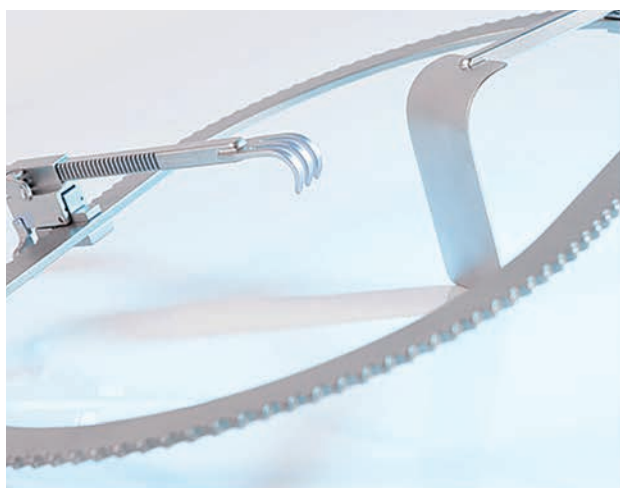

**Castroviejo Micro Needle Holders Flat Handle TC 1 mm Jaw**



**1 mm TC Inserts Jaw**  
Suture 5-0 and smaller



**Tungsten Carbide Inserts**

**Description**

**Length**

**Code**

Castroviejo Micro Needle Holder Straight Flat Handle TC w/catch	12 cm	BI-1336-12
Castroviejo Micro Needle Holder Curved Flat Handle TC w/catch	12 cm	BI-1338-12
Castroviejo Micro Needle Holder Straight Flat Handle TC w/catch	14 cm	BI-1336-14
Castroviejo Micro Needle Holder Curved Flat Handle TC w/catch	14 cm	BI-1338-14
Castroviejo Micro Needle Holder Straight Flat Handle TC w/catch	18 cm	BI-1336-18
Castroviejo Micro Needle Holder Curved Flat Handle TC w/catch	18 cm	BI-1338-18
Castroviejo Micro Needle Holder Straight Flat Handle TC w/catch	21 cm	BI-1336-21
Castroviejo Micro Needle Holder Curved Flat Handle TC w/catch	21 cm	BI-1338-21
Castroviejo Micro Needle Holder Straight Flat Handle TC w/catch	23 cm	BI-1336-23
Castroviejo Micro Needle Holder Curved Flat Handle TC w/catch	23 cm	BI-1338-23
Castroviejo Micro Needle Holder Straight Flat Handle TC w/catch	25 cm	BI-1336-25
Castroviejo Micro Needle Holder Curved Flat Handle TC w/catch	25 cm	BI-1338-25



**MICRO NEEDLE HOLDER**

# MICRO NEEDLE HOLDER

## Castroviejo Micro Needle Holder Flat Handle TC 1.2 mm Jaw



1.2 mm TC Inserts Jaw  
Suture 5-0 and smaller



Tungsten  
Carbide Inserts

Description	Length	Code
Castroviejo Micro Needle Holder Straight Flat Handle TC w/catch	18 cm	BI-1228-18
Castroviejo Micro Needle Holder Curved Flat Handle TC w/catch	18 cm	BI-1229-18
Castroviejo Micro Needle Holder Straight Flat Handle TC w/catch	21 cm	BI-1228-21
Castroviejo Micro Needle Holder Curved Flat Handle TC w/catch	21 cm	BI-1229-21
Castroviejo Micro Needle Holder Straight Flat Handle TC w/catch	23 cm	BI-1228-23
Castroviejo Micro Needle Holder Curved Flat Handle TC w/catch	23 cm	BI-1229-23



Castroviejo Micro Needle Holders Flat Handle TC 1.5 mm Jaw



1.5 mm TC Inserts Jaw  
Suture 5-0 and smaller



Tungsten  
Carbide Inserts

Description	Length	Code
Castroviejo Micro Needle Holder Straight Flat Handle TC w/catch	12 cm	BI-1337-12
Castroviejo Micro Needle Holder Curved Flat Handle TC w/catch	12 cm	BI-1339-12
Castroviejo Micro Needle Holder Straight Flat Handle TC w/catch	14 cm	BI-1337-14
Castroviejo Micro Needle Holder Curved Flat Handle TC w/catch	14 cm	BI-1339-14
Castroviejo Micro Needle Holder Straight Flat Handle TC w/catch	18 cm	BI-1337-18
Castroviejo Micro Needle Holder Curved Flat Handle TC w/catch	18 cm	BI-1339-18
Castroviejo Micro Needle Holder Straight Flat Handle TC w/catch	21 cm	BI-1337-21
Castroviejo Micro Needle Holder Curved Flat Handle TC w/catch	21 cm	BI-1339-21
Castroviejo Micro Needle Holder Straight Flat Handle TC w/catch	23 cm	BI-1337-23
Castroviejo Micro Needle Holder Curved Flat Handle TC w/catch	23 cm	BI-1339-23
Castroviejo Micro Needle Holder Straight Flat Handle TC w/catch	25 cm	BI-1337-25
Castroviejo Micro Needle Holder Curved Flat Handle TC w/catch	25 cm	BI-1339-25



MICRO NEEDLE HOLDER

# MICRO NEEDLE HOLDER

## Jacobson Micro Needle Holder Round Handle TC 1 mm Jaw



1 mm TC Inserts Jaw  
Suture 5-0 and smaller



Tungsten  
Carbide Inserts

Description	Length	Code
Jacobson Micro Needle Holder Straight Round Handle TC w/catch	14 cm	BI-1331-14
Jacobson Micro Needle Holder Curved Round Handle TC w/catch	14 cm	BI-1333-14
Jacobson Micro Needle Holder Straight Round Handle TC w/catch	18 cm	BI-1331-18
Jacobson Micro Needle Holder Curved Round Handle TC w/catch	18 cm	BI-1333-18
Jacobson Micro Needle Holder Straight Round Handle TC w/catch	21 cm	BI-1331-21
Jacobson Micro Needle Holder Curved Round Handle TC w/catch	21 cm	BI-1333-21
Jacobson Micro Needle Holder Straight Round Handle TC w/catch	23 cm	BI-1331-23
Jacobson Micro Needle Holder Curved Round Handle TC w/catch	23 cm	BI-1333-23
Jacobson Micro Needle Holder Straight Round Handle TC w/catch	25 cm	BI-1331-25
Jacobson Micro Needle Holder Curved Round Handle TC w/catch	25 cm	BI-1333-25
Jacobson Micro Needle Holder Straight Round Handle TC w/catch	28 cm	BI-1331-28
Jacobson Micro Needle Holder Curved Round Handle TC w/catch	28 cm	BI-1333-28



**Jacobson Micro Needle Holder Round Handle TC 1.2 mm Jaw**



1.2 mm TC Inserts Jaw  
Suture 5-0 and smaller



Tungsten  
Carbide Inserts

**Description**

**Length**

**Code**

Jacobson Micro Needle Holder Straight Round Handle TC w/catch	14 cm	BI-1332-14
Jacobson Micro Needle Holder Curved Round Handle TC w/catch	14 cm	BI-1334-14
Jacobson Micro Needle Holder Straight Round Handle TC w/catch	18 cm	BI-1332-18
Jacobson Micro Needle Holder Curved Round Handle TC w/catch	18 cm	BI-1334-18
Jacobson Micro Needle Holder Straight Round Handle TC w/catch	21 cm	BI-1332-21
Jacobson Micro Needle Holder Curved Round Handle TC w/catch	21 cm	BI-1334-21
Jacobson Micro Needle Holder Straight Round Handle TC w/catch	23 cm	BI-1332-23
Jacobson Micro Needle Holder Curved Round Handle TC w/catch	23 cm	BI-1334-23
Jacobson Micro Needle Holder Straight Round Handle TC w/catch	25 cm	BI-1332-25
Jacobson Micro Needle Holder Curved Round Handle TC w/catch	25 cm	BI-1334-25
Jacobson Micro Needle Holder Straight Round Handle TC w/catch	28 cm	BI-1332-28
Jacobson Micro Needle Holder Curved Round Handle TC w/catch	28 cm	BI-1334-28

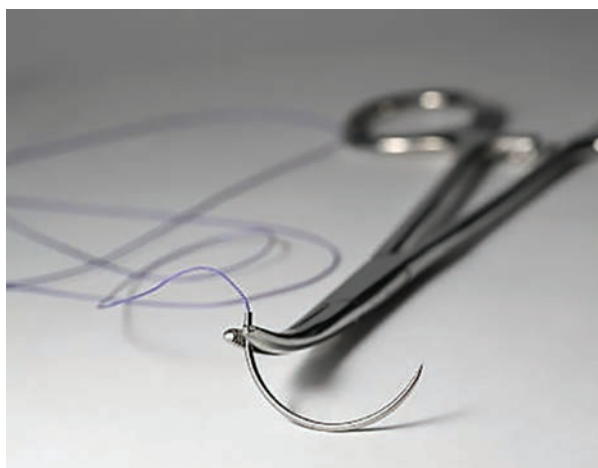

**MICRO NEEDLE HOLDER**

**Heavy Jacobson Round Handle Needle Holder TC 2 mm Jaw**

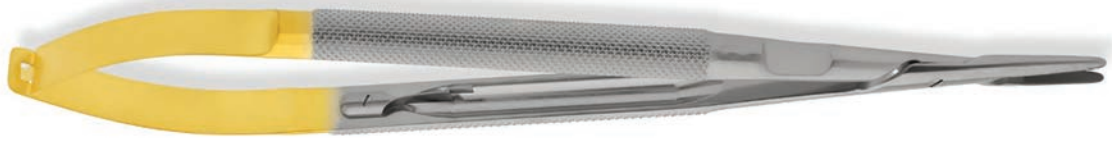

2 mm TC Inserts Jaw  
Suture 4-0 and smaller



  
Tungsten  
Carbide Inserts

Description	Length	Code
Jacobson Micro Needle Holder Straight Round Handle TC w/catch	18 cm	BI-1340-18
Jacobson Micro Needle Holder Curved Round Handle TC w/catch	18 cm	BI-1342-18
Jacobson Micro Needle Holder Straight Round Handle TC w/catch	21 cm	BI-1340-21
Jacobson Micro Needle Holder Curved Round Handle TC w/catch	21 cm	BI-1342-21
Jacobson Micro Needle Holder Straight Round Handle TC w/catch	23 cm	BI-1340-23
Jacobson Micro Needle Holder Curved Round Handle TC w/catch	23 cm	BI-1342-23

**Heavy Jacobson Round Handle Needle Holder TC 2.5 mm Jaw**

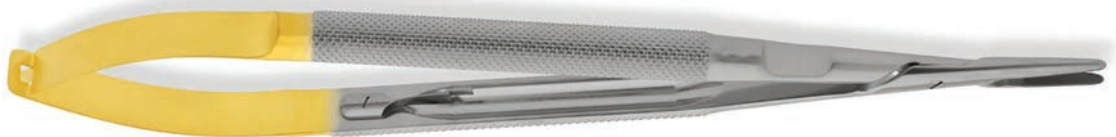

2.5 mm Jaw Diamond Dusted  
for sutures 2-0 and smaller



  
Tungsten  
Carbide Inserts

Description	Length	Code
Jacobson Micro Needle Holder Straight Round Handle TC w/catch	18 cm	BI-1341-18
Jacobson Micro Needle Holder Straight Round Handle TC w/catch	21 cm	BI-1341-21
Jacobson Micro Needle Holder Straight Round Handle TC w/catch	23 cm	BI-1341-23
Jacobson Micro Needle Holder Curved Round Handle TC w/catch	18 cm	BI-1343-18
Jacobson Micro Needle Holder Curved Round Handle TC w/catch	21 cm	BI-1343-21
Jacobson Micro Needle Holder Curved Round Handle TC w/catch	23 cm	BI-1343-23

**Heavy Jacobson Round Handle Needle Holder Diamond Dusted 2 mm Jaw**



2 mm Jaw Diamond Dusted  
for sutures 2-0 and smaller



Diamond  
Dust Inserts

**Description**

- Jacobson Micro Needle Holder Straight Round Handle w/catch
- Jacobson Micro Needle Holder Curved Round Handle w/catch
- Jacobson Micro Needle Holder Straight Round Handle w/catch
- Jacobson Micro Needle Holder Curved Round Handle w/catch
- Jacobson Micro Needle Holder Straight Round Handle w/catch
- Jacobson Micro Needle Holder Curved Round Handle w/catch

**Length**

- 19 cm
- 19 cm
- 23 cm
- 23 cm
- 25 cm
- 25 cm

**Code**

- BI-1344-19
- BI-1345-19
- BI-1344-23
- BI-1345-23
- BI-1344-25
- BI-1345-25

**Heavy Jacobson Round Handle Needle Holder Diamond Dusted 2.5 mm Jaw**



2.5 mm Jaw Diamond Dusted  
for sutures 2-0 and smaller



Diamond  
Dust Inserts

**Description**

- Jacobson Micro Needle Holder Straight Round Handle w/catch
- Jacobson Micro Needle Holder Curved Round Handle w/catch
- Jacobson Micro Needle Holder Straight Round Handle w/catch
- Jacobson Micro Needle Holder Curved Round Handle w/catch
- Jacobson Micro Needle Holder Straight Round Handle w/catch
- Jacobson Micro Needle Holder Curved Round Handle w/catch

**Length**

- 19 cm
- 19 cm
- 23 cm
- 23 cm
- 25 cm
- 25 cm

**Code**

- BI-1346-19
- BI-1347-19
- BI-1346-23
- BI-1347-23
- BI-1346-25
- BI-1347-25

**Titanium Heavy Jacobson Round Handle Needle Holder  
Diamond Dusted 2 mm Jaw**



2 mm Diamond Dusted Jaw  
Suture 2-0 and smaller



Diamond  
Dust Inserts



Description	Length	Code
Titanium Jacobson Micro Needle Holder Straight Round Handle w/catch	19 cm	BI-1344-19T
Titanium Jacobson Micro Needle Holder Curved Round Handle w/catch	19 cm	BI-1345-19T
Titanium Jacobson Micro Needle Holder Straight Round Handle w/catch	23 cm	BI-1344-23T
Titanium Jacobson Micro Needle Holder Curved Round Handle w/catch	23 cm	BI-1345-23T
Titanium Jacobson Micro Needle Holder Straight Round Handle w/catch	25 cm	BI-1344-25T
Titanium Jacobson Micro Needle Holder Curved Round Handle w/catch	25 cm	BI-1345-25T

**Titanium Heavy Jacobson Round Handle Needle Holder  
Diamond Dusted 2.5 mm Jaw**



2 mm Diamond Dusted Jaw  
Suture 2-0 and smaller



Diamond  
Dust Inserts



Description	Length	Code
Titanium Jacobson Micro Needle Holder Straight Round Handle w/catch	19 cm	BI-1346-19T
Titanium Jacobson Micro Needle Holder Curved Round Handle w/catch	19 cm	BI-1347-19T
Titanium Jacobson Micro Needle Holder Straight Round Handle w/catch	23 cm	BI-1346-23T
Titanium Jacobson Micro Needle Holder Curved Round Handle w/catch	23 cm	BI-1347-23T
Titanium Jacobson Micro Needle Holder Straight Round Handle w/catch	25 cm	BI-1346-25T
Titanium Jacobson Micro Needle Holder Curved Round Handle w/catch	25 cm	BI-1347-25T

**Ryder-Vascular Needle Holder TC**

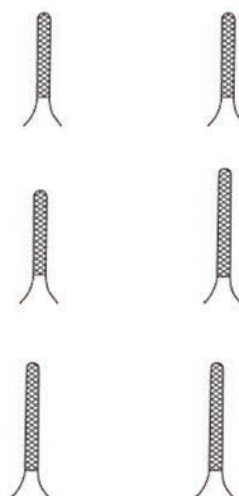

**Description**

- Ryder-Vascular Needle Holder TC
- Ryder-Vascular Needle Holder TC
- Ryder-Vascular Needle Holder TC
- Ryder-Vascular Needle Holder TC
- Ryder-Vascular Needle Holder TC
- Ryder-Vascular Needle Holder TC

**Length**

- 13 cm
- 15 cm
- 18 cm
- 20 cm
- 23 cm
- 26 cm

**Code**

- BI-110-13
- BI-110-15
- BI-110-18
- BI-110-20
- BI-110-23
- BI-110-26

**Halsey Needle Holder TC**

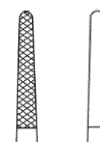

**Description**

- Halsey Needle Holder TC Serrated Jaw
- Halsey Needle Holder TC Smooth Jaw

**Length**

- 13 cm
- 13 cm

**Code**

- BI-026-13
- BI-028-13

# MICRO NEEDLE HOLDER

## Micro-Vascular Needle Holder TC



**Description**

Micro-Vascular Needle Holder TC  
 Micro-Vascular Needle Holder TC  
 Micro-Vascular Needle Holder TC  
 Micro-Vascular Needle Holder TC

**Length**

14 cm  
 18 cm  
 20 cm  
 23 cm

**Code**

BI-109-14  
 BI-109-18  
 BI-109-20  
 BI-109-23

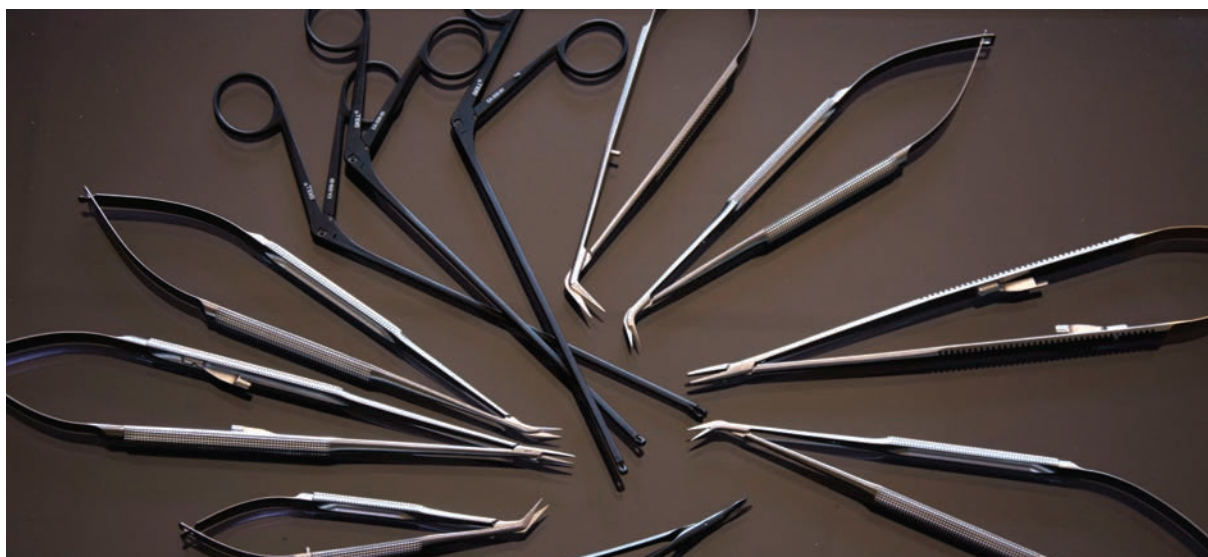

DeBakey Needle Holder TC

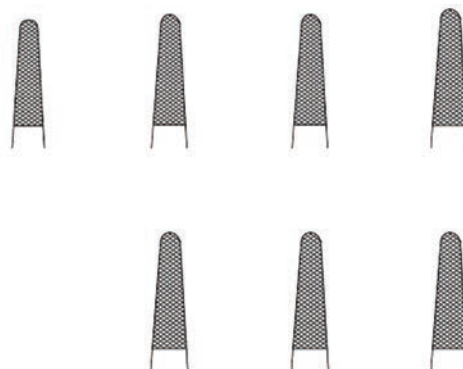

**Description**

- DeBakey Needle Holder TC
- DeBakey Needle Holder TC
- DeBakey Needle Holder TC
- DeBakey Needle Holder TC
- DeBakey Needle Holder TC
- DeBakey Needle Holder TC
- DeBakey Needle Holder TC
- DeBakey Needle Holder TC

**Length**

- 15 cm
- 16 cm
- 18 cm
- 20 cm
- 23 cm
- 26 cm
- 31 cm
- 37 cm

**Code**

- BI-004-15
- BI-004-16
- BI-004-18
- BI-004-20
- BI-004-23
- BI-004-26
- BI-004-31
- BI-004-37



MICRO NEEDLE HOLDER

# MICRO NEEDLE HOLDER

## Micro Ryder-Vascular Needle Holder TC

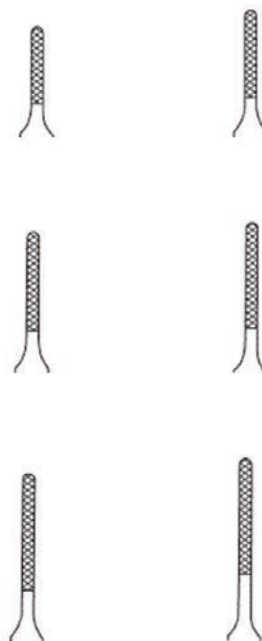

**Description**

- Micro Ryder-Vascular Needle Holder TC
- Micro Ryder-Vascular Needle Holder TC
- Micro Ryder-Vascular Needle Holder TC
- Micro Ryder-Vascular Needle Holder TC
- Micro Ryder-Vascular Needle Holder TC
- Micro Ryder-Vascular Needle Holder TC

**Length**

- 13 cm
- 15 cm
- 18 cm
- 20 cm
- 23 cm
- 26 cm

**Code**

- BI-112-13
- BI-112-15
- BI-112-18
- BI-112-20
- BI-112-23
- BI-112-26



Mayo Hegar Needle Holder TC

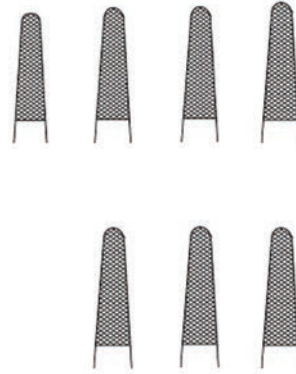

**Description**

- Mayo Hegar Needle Holder TC
- Mayo Hegar Needle Holder TC
- Mayo Hegar Needle Holder TC
- Mayo Hegar Needle Holder TC
- Mayo Hegar Needle Holder TC
- Mayo Hegar Needle Holder TC
- Mayo Hegar Needle Holder TC
- Mayo Hegar Needle Holder TC
- Mayo Hegar Needle Holder TC

**Length**

- 14 cm
- 16 cm
- 18 cm
- 20 cm
- 24 cm
- 26 cm
- 30 cm
- 36 cm
- 40 cm

**Code**

- BI-512-14
- BI-512-16
- BI-512-18
- BI-512-20
- BI-512-24
- BI-512-26
- BI-512-30
- BI-512-36
- BI-512-40



MICRO NEEDLE HOLDER

# MICRO NEEDLE HOLDER

## Crile-Wood Needle Holder TC

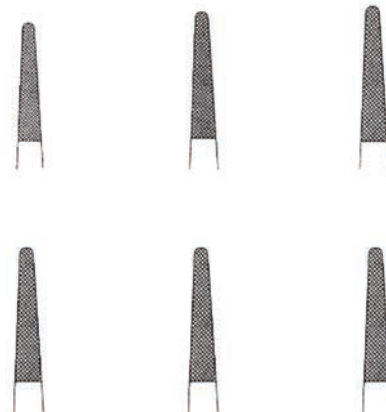

**Description**

- Crile-Wood Needle Holder TC
- Crile-Wood Needle Holder TC
- Crile-Wood Needle Holder TC
- Crile-Wood Needle Holder TC
- Crile-Wood Needle Holder TC
- Crile-Wood Needle Holder TC

**Length**

- 15 cm
- 18 cm
- 20 cm
- 23 cm
- 26 cm
- 31 cm

**Code**

- BI-001-15
- BI-001-18
- BI-001-20
- BI-001-23
- BI-001-26
- BI-001-31

## Neivert Needle Holder TC



**Description**

- Neivert Needle Holder TC

**Length**

- 13 cm

**Code**

- BI-024-13

### Baumgartner Wire Forceps



Description	Total Length	Code
Baumgartner Wire Forceps TC	20 cm	EB-1911-20

### Wire Forceps TC Rounded



Description	Total Length	Code
Wire Forceps TC Rounded Jaw	15 cm	EB-1925-15
Wire Forceps TC Rounded Jaw	18 cm	EB-1925-18
Wire Forceps TC Rounded Jaw	20 cm	EB-1925-20



**Wire Forceps TC Square Jaw**

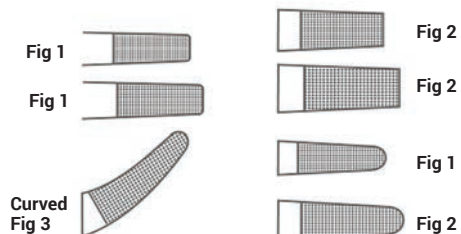

Description	Total Length	Code
Wire Forceps TC Square Jaw	15 cm	EB-1913-15
Wire Forceps TC Square Jaw	18 cm	EB-1913-18
Wire Forceps TC Square Jaw	20 cm	EB-1913-20
Wire Forceps TC Fine Round Jaw	15 cm	EB-1924-15
Wire Forceps TC Fine Round Jaw	18 cm	EB-1925-18
Wire Forceps TC Fine Square Jaw	15 cm	EB-1927-15
Wire Forceps TC Fine Square Jaw	18 cm	EB-1927-18
Wire Forceps TC Round Curved Jaw	18 cm	EB-1928-18



**Wire Forceps Serrated Jaw**



Description	Total Length	Code
Wire Forceps Serrated Jaw	15 cm	EB-1930-15
Wire Forceps Serrated jaw	18 cm	EB-1930-18
Wire Forceps Serrated Jaw	20 cm	EB-1930-20
Wire Forceps Serrated Jaw	22 cm	EB-1930-22

**Wire Cutter TC**



Description	Total Length	Code
Wire Cutter TC	16 cm	EB-1873-16

Wire Cutter TC



For soft wires  
up to Ø 2.0 mm  
For hard wires  
up to Ø 1.7 mm



For soft wires  
up to Ø 2.8 mm  
For hard wires  
up to Ø 2.2 mm

Description

Wire Cutter TC

Wire Cutter TC

Total Length

18 cm

22 cm

Code

EB-1873-18

EB-1873-22



**SKILL**<sup>®</sup>  
Surgical Instruments

**MICRO  
VASCULAR CLAMPS**





# Index

## Micro Vascular Clamps

Cooley Paediatric Vascular Clamp	174-196
Cooley Vascular Clamp	196
Cooley Vena Cava Vascular Clamp	197
Castaneda Neonatal Vascular Clamp	198-201
Castaneda Paediatric Clamp	202-203
Titanium Micro Kitzmiller Neonatal Vascular Clamp	204
DeBakey Vascular Clamp	204-230
Favaloro Vascular Clamp   Lambert-Kay Vascular Clamp	231
Parsonnet Vascular Clamp	232
Strong Aorta Vascular Clamp	233
Fogerty Insert Clamp	234
Leland-Jones Vascular Clamp	235
Wylie Clamp	235-239
Liver Clamp	239
Pean Artery Forceps Straight   Curved	240-241
Spencer-Wells Artery Forceps Straight	242
Heiss Artery Forceps   Adson Artery Forceps	243
Crile Artery Forceps   Kelly Artery Forceps	244
Birkett Artery Forceps   Halsted-Mosquito Artery Forceps	245
Micro-Mosquito Artery Forceps	246
Kocher Artery Forceps Straight	247
Kocher Artery Forceps Curved	248
Gemini Artery Forceps Curved   Crafoord Artery Forceps Curved	249
Roberts Artery Forceps   Bailey Fine Forceps	250
Mixer Artery Forceps Curved	251-252
Lahey Artery Forceps	252
Rampleny Sponge Holding Forceps   Duval Grasping Forceps	253
Duval DeBakey Grasping Forceps   Babcock Grasping Forceps	254
Allis Grasping Forceps   Littlewood Grasping Forceps	255
Backhaus Towel Forceps   Ball & Socket Towel Forceps	256
Lane Towel Forceps   Lorna Towel Forceps	257
Tubing Clamp Forceps Straight   Tubing Clamp With Guard Forceps Straight	258
O'Shaughnessy Artery Forceps   Gregory Suture Tag Forceps	259

### Cooley Ultralight Paediatric Vascular Clamp Jaw 1.5 mm

Description	Length	Code
Cooley Ultralight Vascular Clamp Handles Straight	13 cm	CC-6300-13
Cooley Ultralight Vascular Clamp Handles Angled	13 cm	CC-6302-13

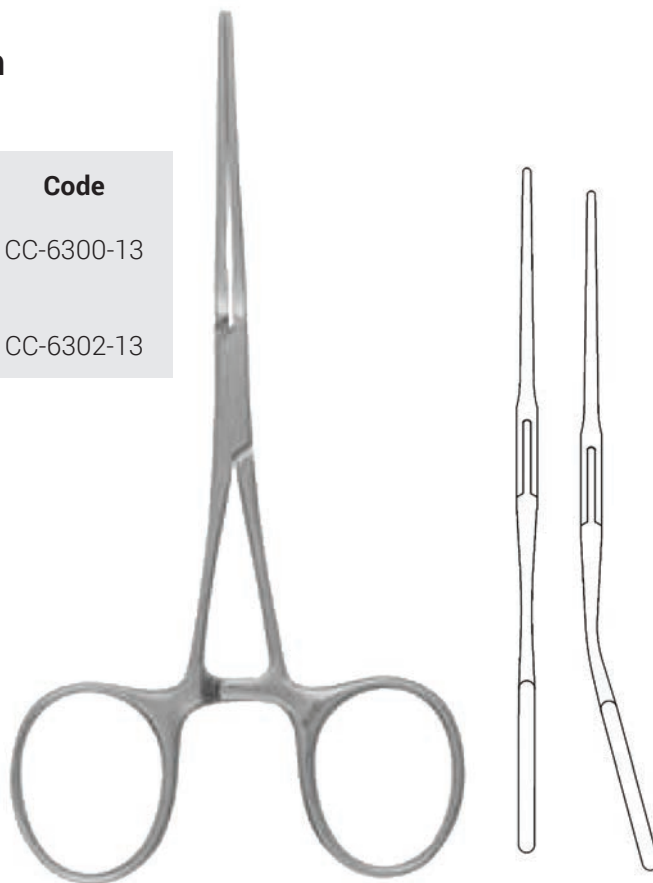

### Cooley Ultralight Paediatric Vascular Clamp Jaw 1.5 mm

Description	Length	Code
Cooley Ultralight Vascular Clamp Handles Straight Jaw Slightly Curved	13 cm	CC-6303-13



### Cooley Ultralight Paediatric Vascular Clamp Jaw 1.5 mm

Description	Length	Code
Cooley Ultralight Vascular Clamp Handles Straight Jaw Curved	12 cm	CC-6306-12

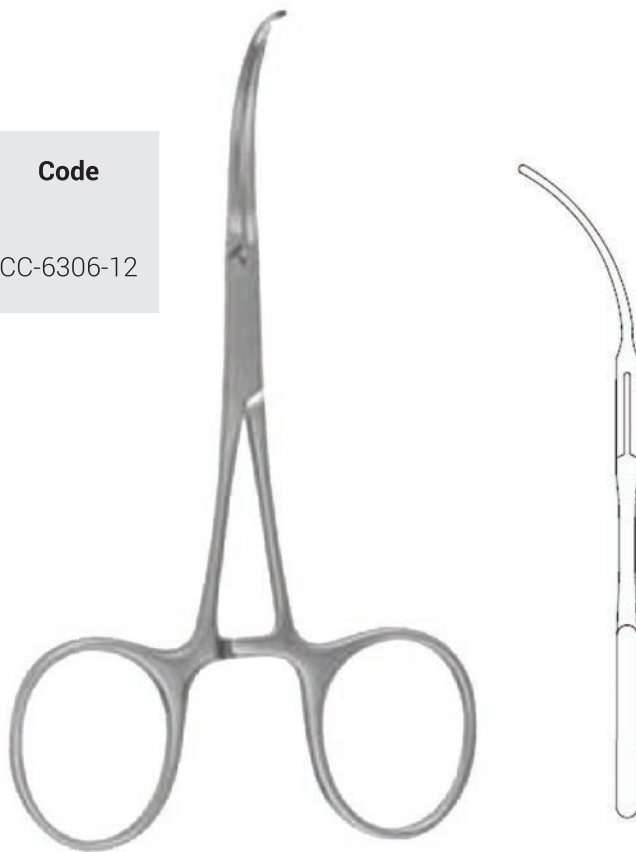

### Cooley Ultralight Paediatric Vascular Clamp Jaw 1.5 mm

Description	Length	Code
Cooley Ultralight Vascular Clamp Handles Curved Jaw Slightly Curved	13 cm	CC-6307-13

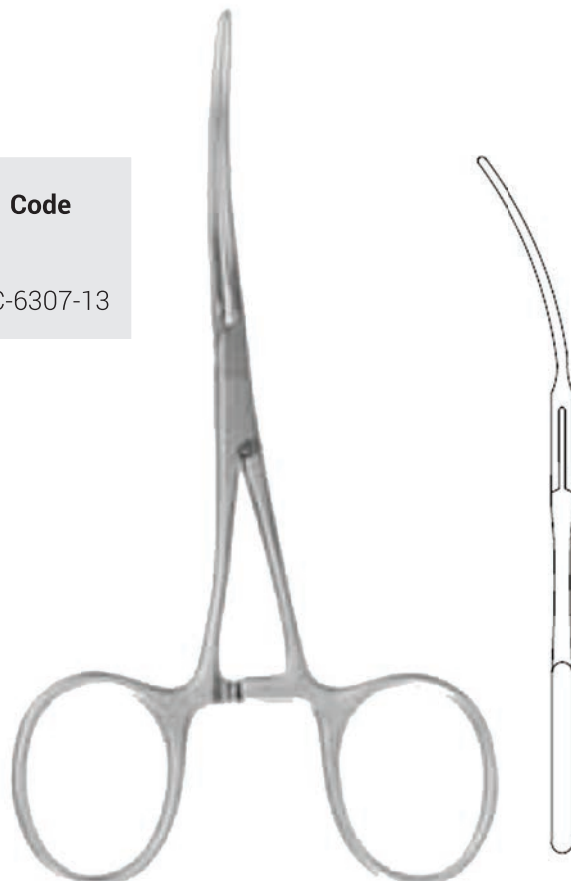

# MICRO VASCULAR CLAMPS

**Cooley Selman Ultralight  
Paediatric Vascular Clamp**

Description	Length	Code
Cooley Selman Ultralight Vascular Clamp Handles/Jaw Straight	13 cm	CC-6150-13
Cooley Selman Ultralight Vascular Clamp Handles/Jaw Straight	14 cm	CC-6152-14

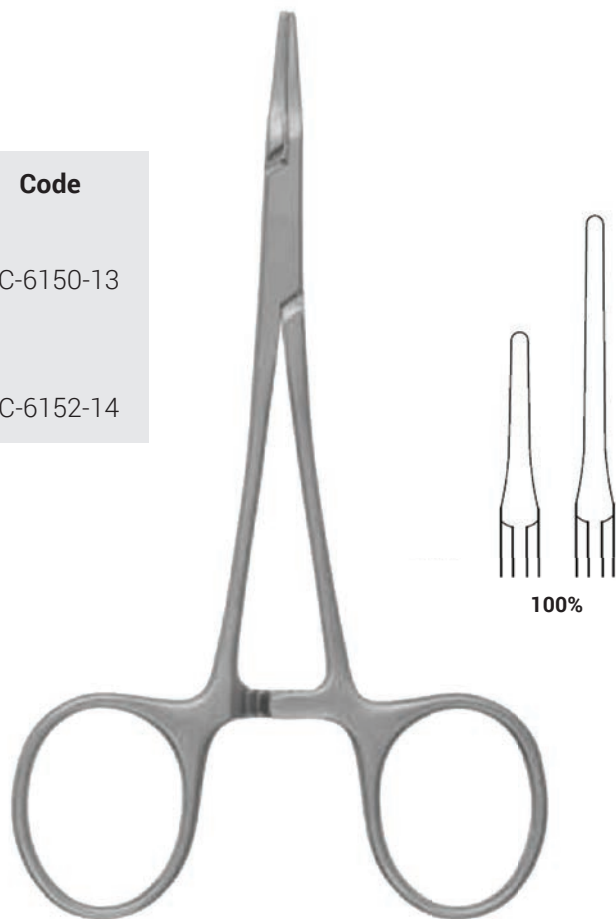

**Cooley Selman Ultralight  
Paediatric Vascular Clamp**

Description	Length	Code
Cooley Selman Ultralight Vascular Clamp Handles Straight Jaw 50°	12 cm	CC-6151-12
Cooley Selman Ultralight Vascular Clamp Handles Straight Jaw 30°	14 cm	CC-6153-14

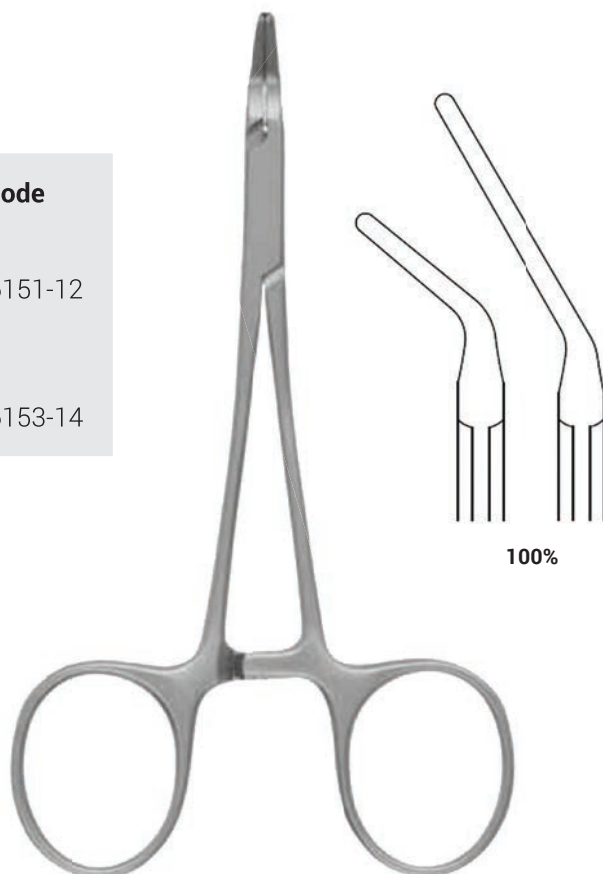

**Cooley Selman Ultralight  
Paediatric Vascular Clamp**

Description	Length	Code
Cooley Selman Ultralight Vascular Clamp Handles Straight Jaw Fully Curved	12 cm	CC-6170-12

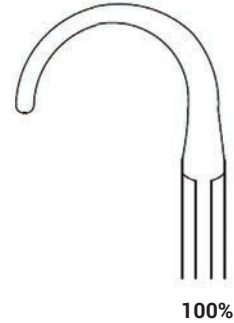

**Cooley Selman Ultralight  
Paediatric Vascular Clamp**

Description	Length	Code
Cooley Selman Vascular Clamp Handles Straight Jaw 90° 20 mm Jaw	12 cm	CC-6355-12
Cooley Selman Vascular Clamp Handles Straight Jaw 90° 30 mm Jaw	12 cm	CC-6356-12
Cooley Selman Vascular Clamp Handles Straight Jaw 90° 40 mm Jaw	12 cm	CC-6357-12

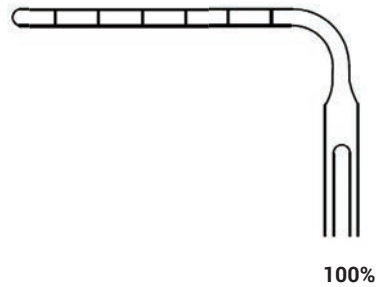
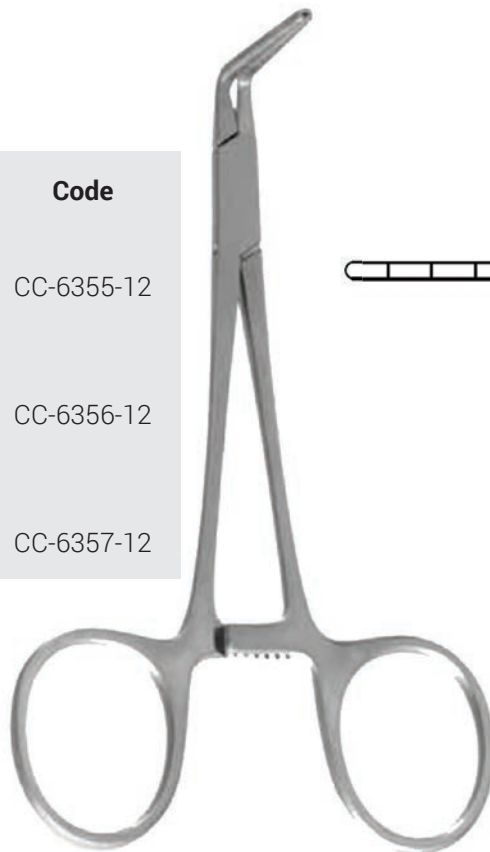

# MICRO VASCULAR CLAMPS

## Cooley Paediatric Vascular Clamp

Description	Length	Code
Cooley Paediatric Vascular Clamp Handles Straight Jaw 30°	14 cm	CC-6351-14

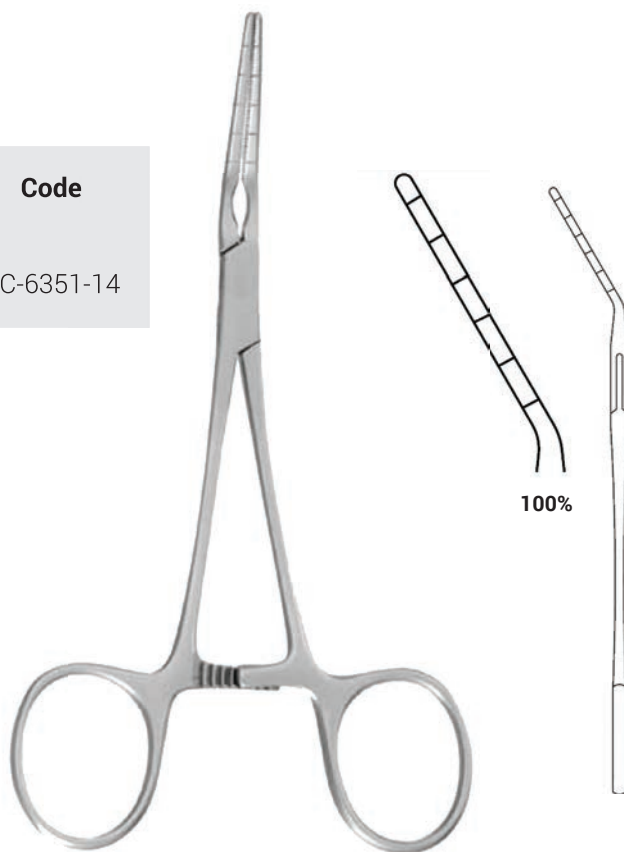

## Cooley Paediatric Vascular Clamp

Description	Length	Code
Cooley Paediatric Vascular Clamp Handles Curved Jaw Straight	14 cm	CC-6352-14

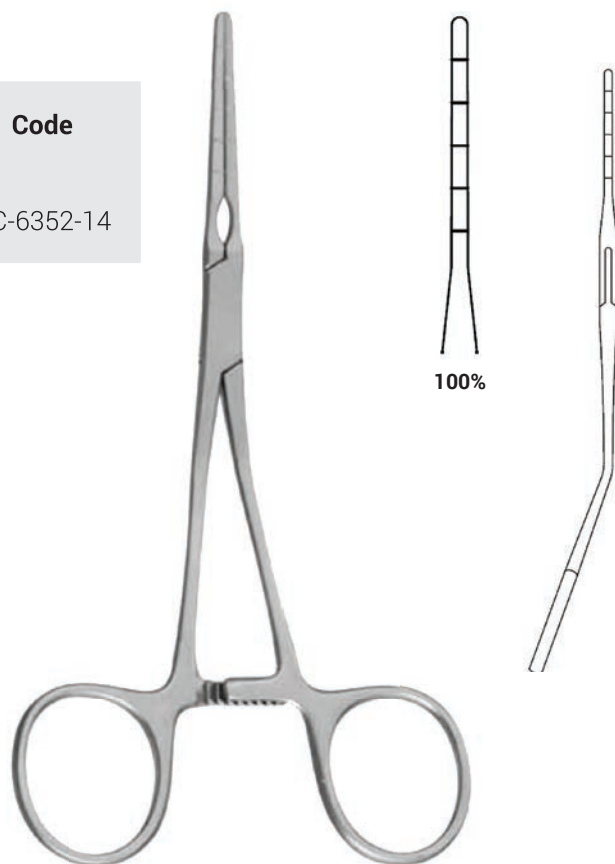

### Cooley Paediatric Vascular Clamp

**Description**

Cooley Paediatric Vascular Clamp  
Handles/Jaw Straight

**Length**

14 cm

**Code**

CC-6350-14

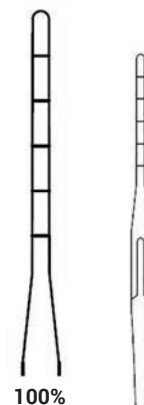

### Cooley Paediatric Vascular Clamp

**Description**

Cooley Paediatric Vascular Clamp Handles  
Curved Jaw Satinsky

**Length**

14 cm

**Code**

CC-6354-14

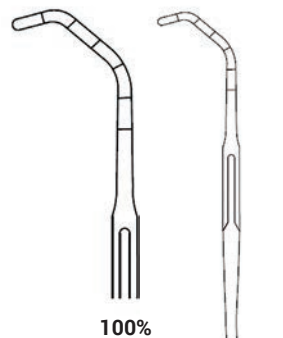

# MICRO VASCULAR CLAMPS

# MICRO VASCULAR CLAMPS

## Cooley Paediatric Vascular Clamp

Description	Length	Code
Cooley Paediatric Vascular Clamp Handles Straight Jaw Spoon Shaped	14 cm	CC-6353-14



## Cooley Paediatric Vascular Clamp

### Cooley Delicate Paediatric Clamps 14 cm

Jaw Type	Handle A Straight	Handle B Curved	Handle C Angled
1	CC-6571-14	CC-6371-14	CC-6581-14
2	CC-6572-14	CC-6372-14	CC-6582-14
3	CC-6573-14	CC-6373-14	CC-6583-14
4	CC-6574-14	CC-6374-14	CC-6584-14
5	CC-6575-14	CC-6375-14	CC-6585-14
6	CC-6576-14	CC-6376-14	CC-6586-14
7	CC-6577-14	CC-6377-14	CC-6587-14
8	CC-6578-14	CC-6378-14	CC-6588-14
9	CC-6570-14	CC-6370-14	CC-6580-14

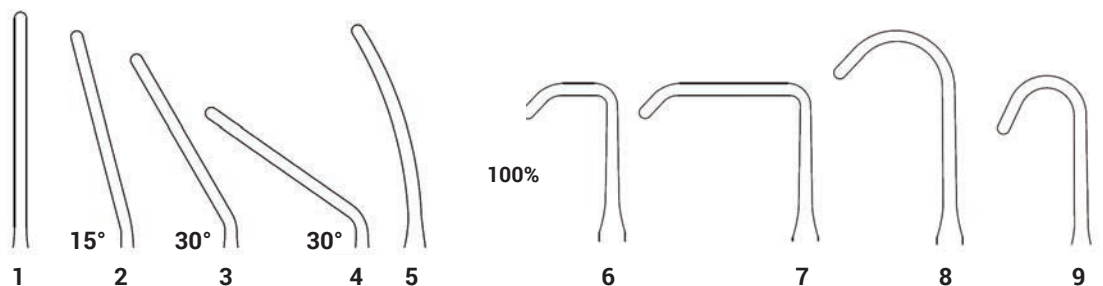
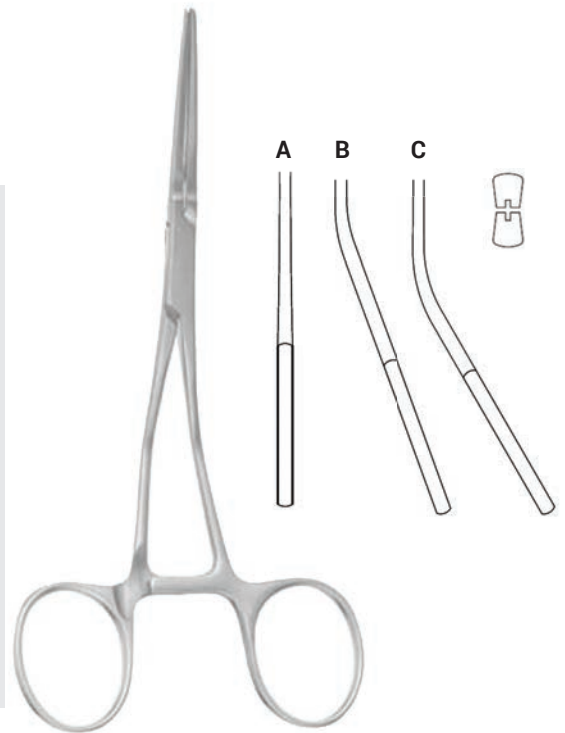

**Cooley Kitzmiller  
Paediatric Vascular Clamp**

Description	Length	Code
Cooley Kitzmiller Vascular Clamp Handles Straight Jaw Curved Left	13 cm	CC-6622-13
Cooley Kitzmiller Vascular Clamp Handles Straight Jaw Curved Right	13 cm	CC-6620-13

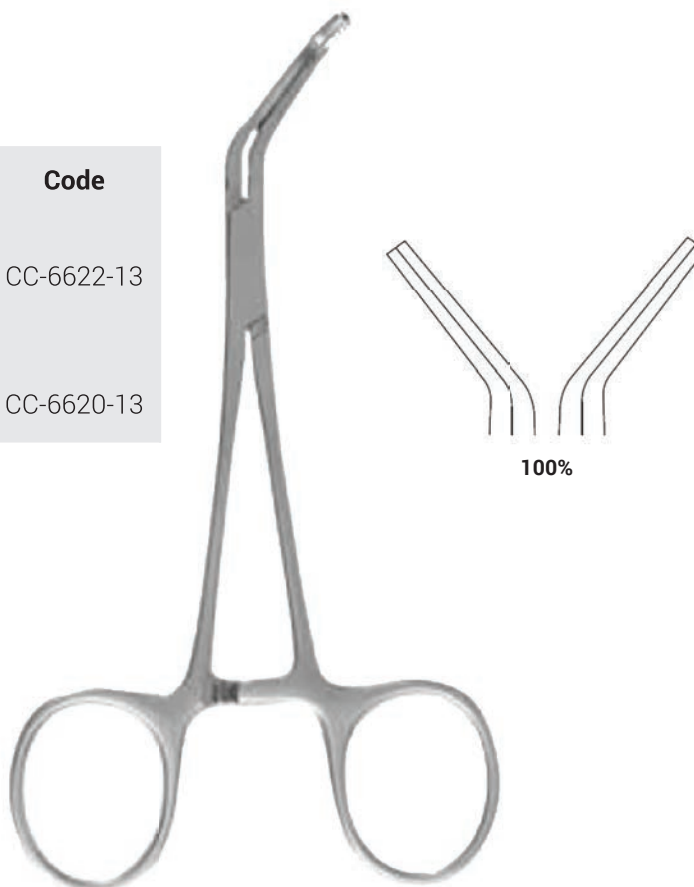

**Cooley Martinez  
Paediatric Vascular Clamp**

Description	Length	Code
Cooley Martinez Vascular Clamp Handles Straight Jaw Curved Left	18 cm	CC-6612-18
Cooley Martinez Vascular Clamp Handles Straight Jaw Curved Right	18 cm	CC-6610-18



### Cooley Paediatric Vascular Clamp

Description	Length	Code
Cooley Vascular Clamp Handles/Jaw Straight	17 cm	CC-5022-17



100%

### Cooley Paediatric Vascular Clamp

Description	Length	Code
Cooley Vascular Clamp Handles Straight Jaw Curved	16 cm	CC-5031-16

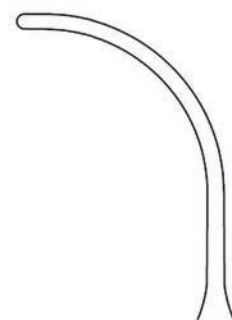

100%

### Cooley Paediatric Vascular Clamp

Description	Length	Code
Cooley Vascular Clamp Handles Curved Jaw 45°	18 cm	CC-5026-18

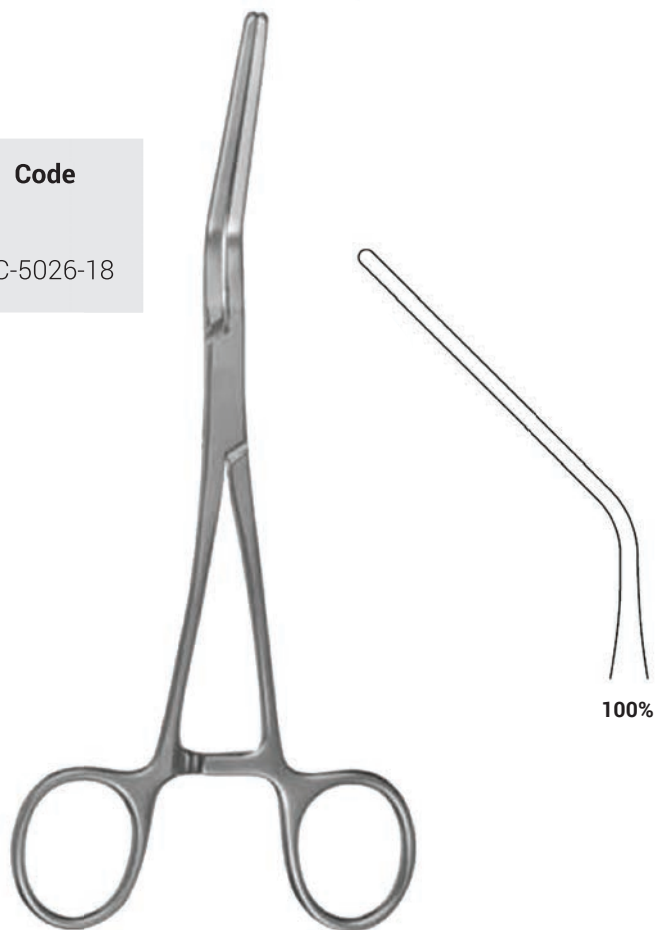

### Cooley Paediatric Vascular Clamp

Description	Length	Code
Cooley Vascular Clamp Handles Curved Jaw 60° Jaw 30 mm	16 cm	CC-5023-16
Cooley Vascular Clamp Handles Curved Jaw 60° Jaw 40 mm	16 cm	CC-5024-16
Cooley Vascular Clamp Handles Curved Jaw 60° Jaw 50 mm	17 cm	CC-5025-17

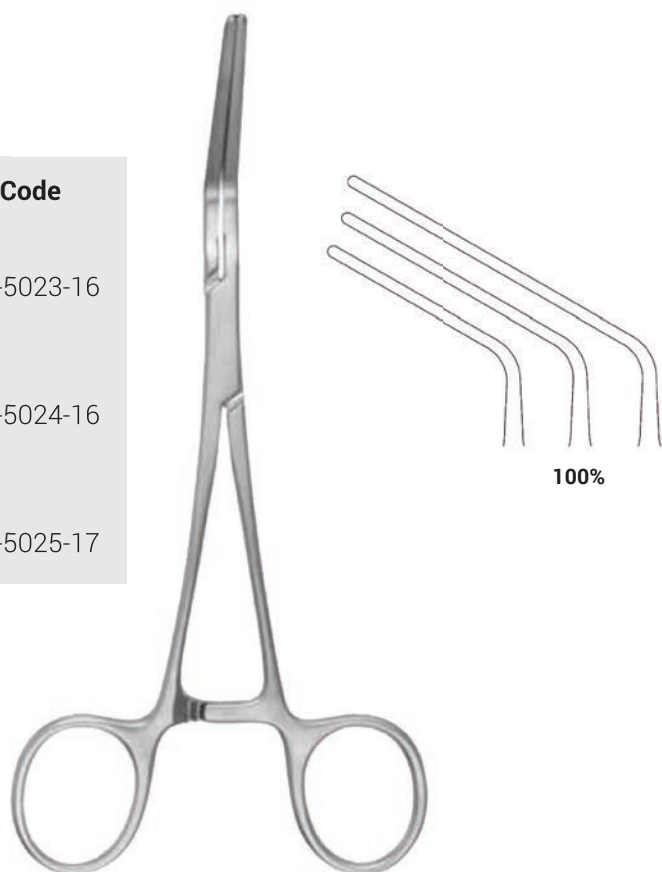

MICRO VASCULAR CLAMPS

**Cooley Paediatric Vascular Clamp**

Description	Length	Code
Cooley Vascular Clamp Handles Straight Jaw Satinsky	14 cm	CC-6520-14

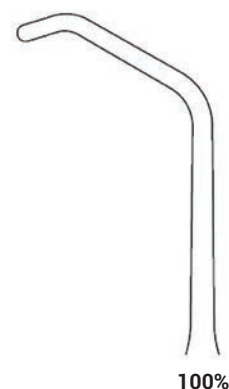

**Cooley Paediatric Vascular Clamp**

Description	Length	Code
Cooley Vascular Clamp Handles/Jaw Straight	16 cm	CC-3800-16
Cooley Vascular Clamp Handles Curved Jaw Straight	16 cm	CC-3801-16

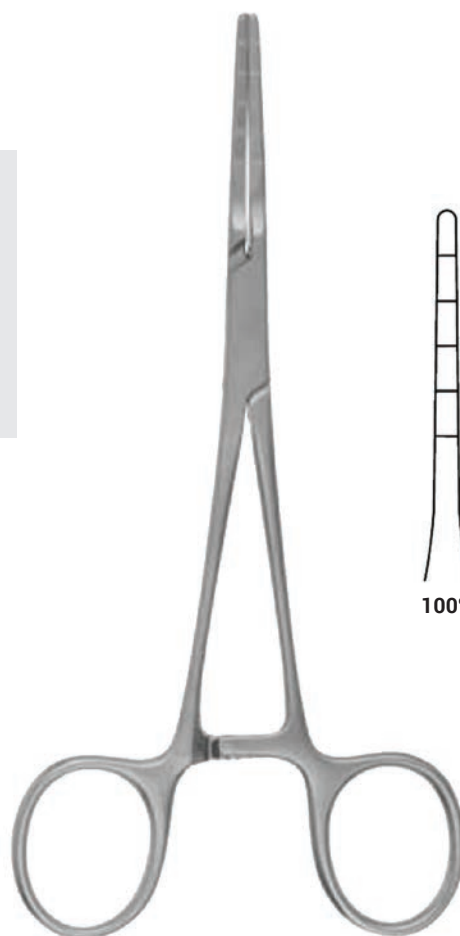

### Cooley Paediatric Vascular Clamp

Description	Length	Code
Cooley Vascular Clamp Handles/Jaw Straight	17 cm	CC-3802-17
Cooley Vascular Clamp Handles Curved Jaw Straight	17 cm	CC-3803-17



### Cooley Paediatric Vascular Clamp

Description	Length	Code
Cooley Vascular Clamp Handles Straight Jaw Slightly Curved	17 cm	CC-3804-17

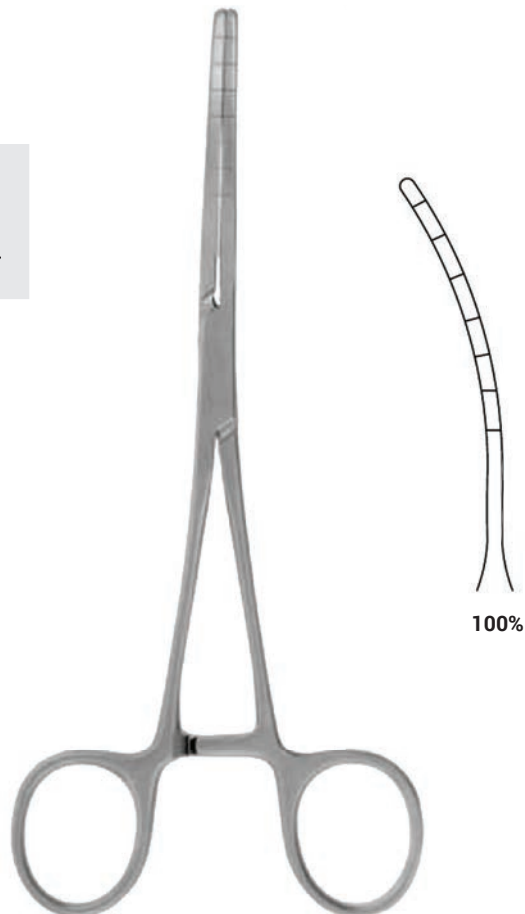

**Cooley Paediatric Vascular Clamp**

Description	Length	Code
Cooley Vascular Clamp Handles Straight Jaw Fully Curved Jaw 28 mm	15 cm	CC-3810-15
Cooley Vascular Clamp Handles Straight Jaw Fully Curved Jaw 35 mm	16 cm	CC-3812-16

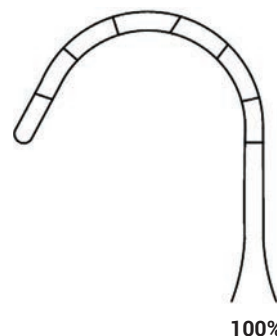

**Cooley Paediatric Vascular Clamp**

Description	Length	Code
Cooley Vascular Clamp Handles Curved Jaw Fully Curved	17 cm	CC-3826-17
Cooley Vascular Clamp Handles Curved Jaw Fully Curved	16 cm	CC-3827-16

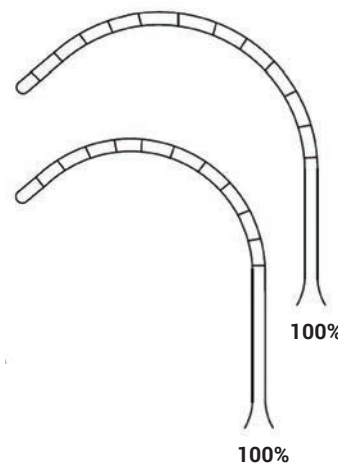
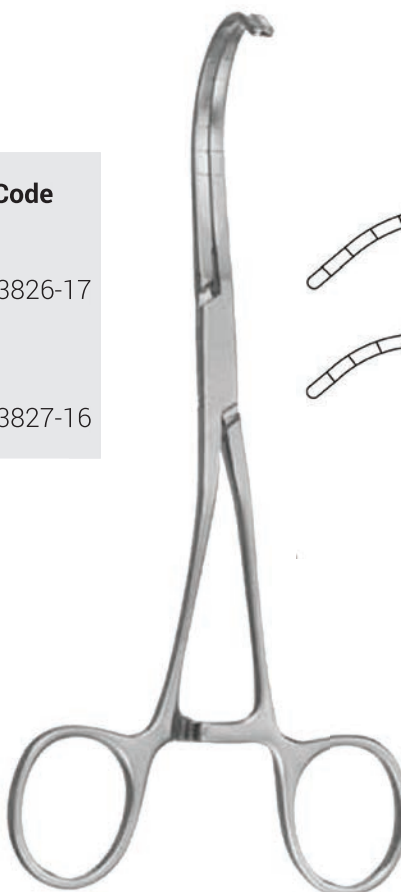

### Cooley Paediatric Vascular Clamp

Description	Length	Code
Cooley Vascular Clamp Handles Straight Jaw Spoonshaped	18 cm	CC-3808-18

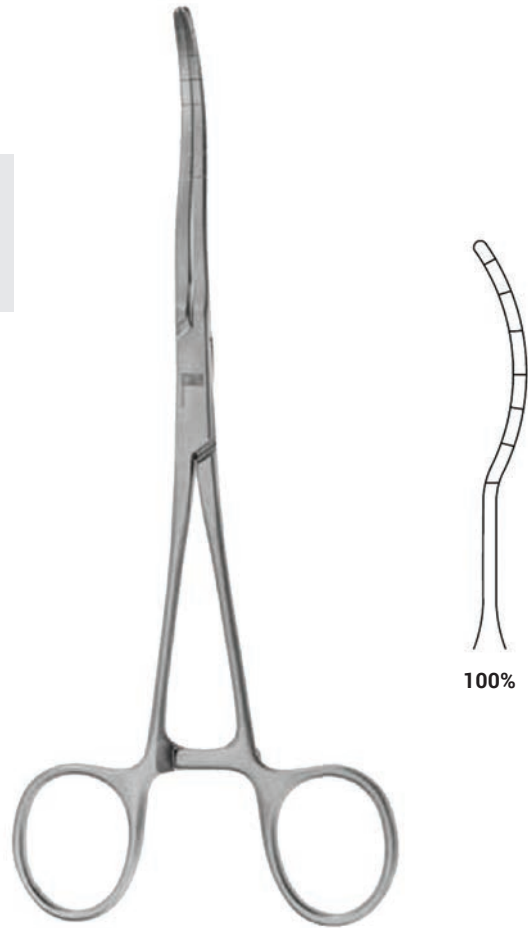

### Cooley Paediatric Vascular Clamp

Description	Length	Code
Cooley Vascular Clamp Handles Curved Jaw Angled 30°	16 cm	CC-3805-16
Cooley Vascular Clamp Handles Curved Jaw Angled 60°	16 cm	CC-3806-16
Cooley Vascular Clamp Handles Curved Jaw Angled 90°	16 cm	CC-3807-16

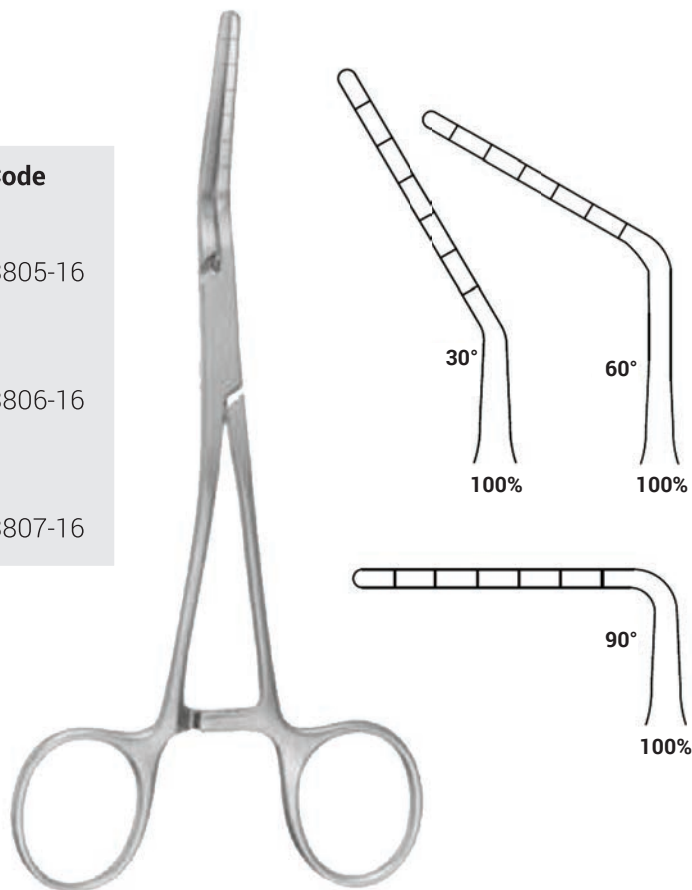

MICRO VASCULAR CLAMPS

**Cooley Derra Paediatric Vascular Clamp**

Description	Length	Code
Cooley Derra Vascular Clamp Handles Curved Jaw Satinsky	17 cm	CC-3815-17
Cooley Derra Vascular Clamp Handles Curved Jaw Satinsky	17 cm	CC-3816-17
Cooley Derra Vascular Clamp Handles Curved Jaw Satinsky	17 cm	CC-3817-17

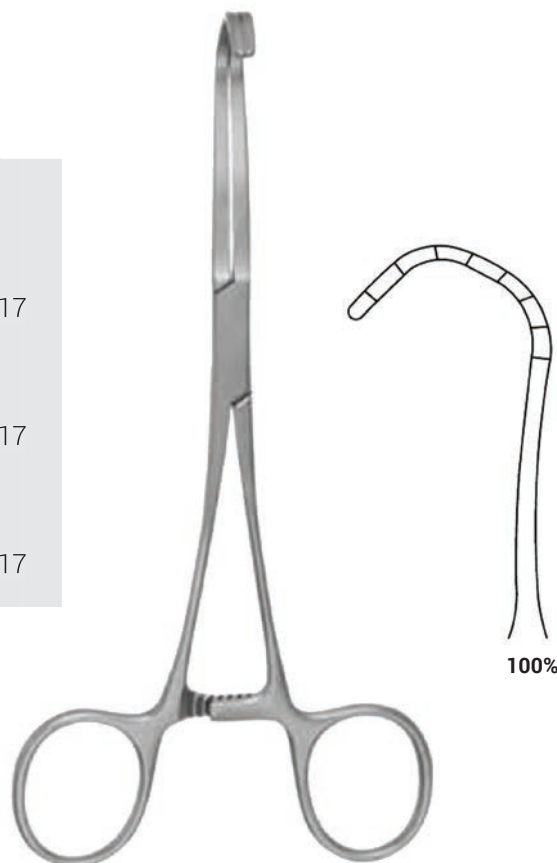

**Cooley Paediatric Vascular Clamp**

Description	Length	Code
Cooley Vascular Clamp Handles Curved Jaw Satinsky 90°	18 cm	CC-3830-18
Cooley Vascular Clamp Handles Curved Jaw Satinsky 90°	18 cm	CC-3831-18

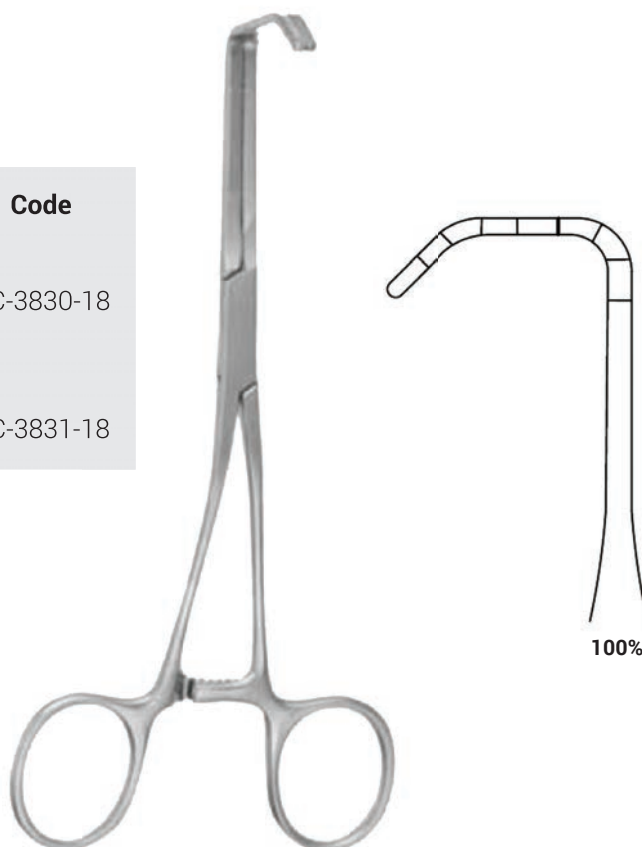

### Cooley Paediatric Vascular Clamp

Description	Length	Code
Cooley Vascular Clamp Handles Curved Jaw Satinsky Jaw 20 mm	16 cm	CC-3125-16



### Cooley Paediatric Vascular Clamp

Description	Length	Code
Cooley Vascular Clamp Handles Curved Jaw Satinsky Jaw 20 mm	16 cm	CC-3845-16

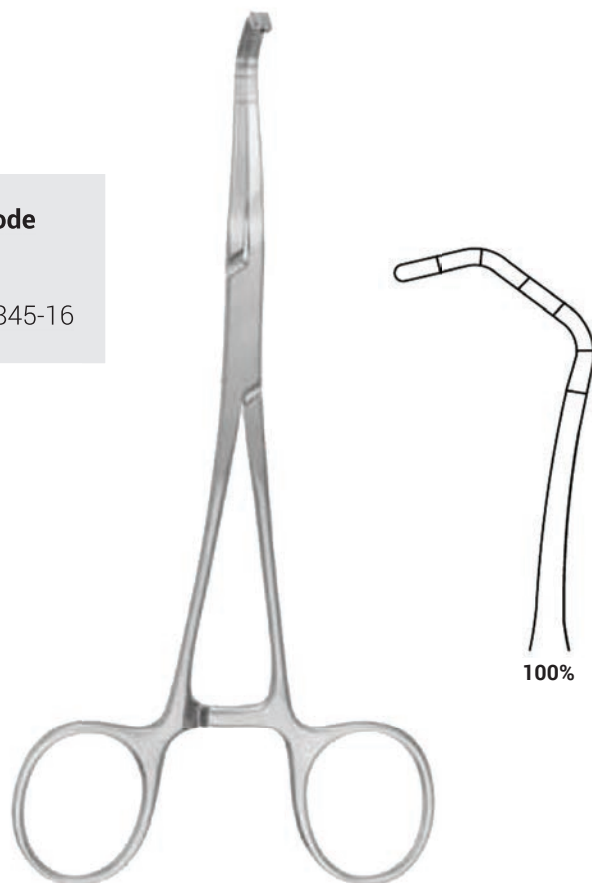

**MICRO VASCULAR CLAMPS**

**Cooley Satinsky Vascular Clamp**

Description	Length	Code
Cooley Satinsky Vascular Clamp Handles Angled Jaw Satinsky Jaw 20 mm	20 cm	CC-3870-20
Cooley Satinsky Vascular Clamp Handles Angled Jaw Satinsky Jaw 30 mm	20 cm	CC-3872-20
Cooley Satinsky Vascular Clamp Handles Angled Jaw Satinsky Jaw 40 mm	20 cm	CC-3874-20

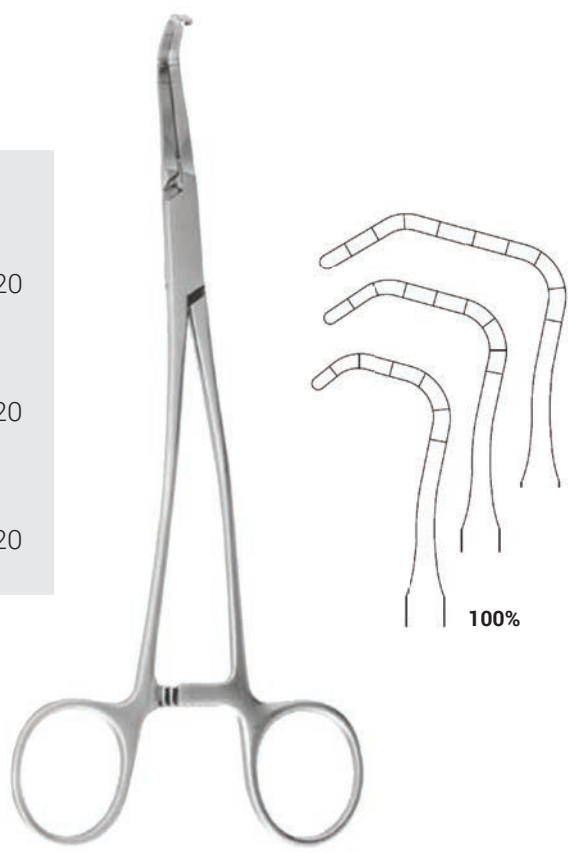

**Cooley Vascular Clamp**

Description	Length	Code
Cooley Vascular Clamp Handles/Jaw Straight Jaw 56 mm	22 cm	CC-5040-22
Cooley Vascular Clamp Handles Angled Jaw Straight Jaw 56 mm	21 cm	CC-5041-21

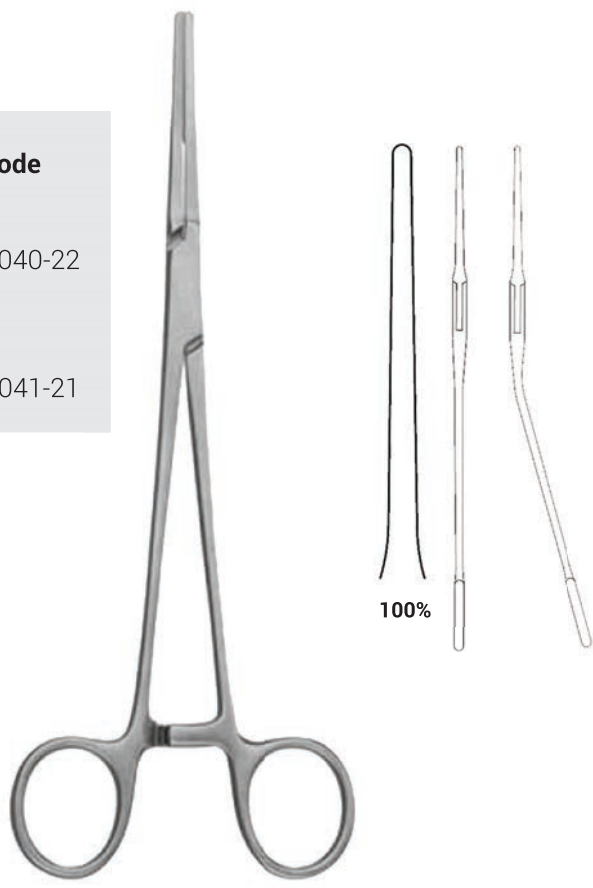

**Cooley Vascular Clamp**

Description	Length	Code
Cooley Vascular Clamp Handles/Jaw Straight Jaw 70 mm	24 cm	CC-5043-24
Cooley Vascular Clamp Handles Angled Jaw Straight Jaw 70 mm	24 cm	CC-5044-24
Cooley Vascular Clamp Handles/Jaw Straight Jaw 50 mm	22 cm	CC-5045-22
Cooley Vascular Clamp Handles Angled Jaw Straight Jaw 50 mm	22 cm	CC-5046-22

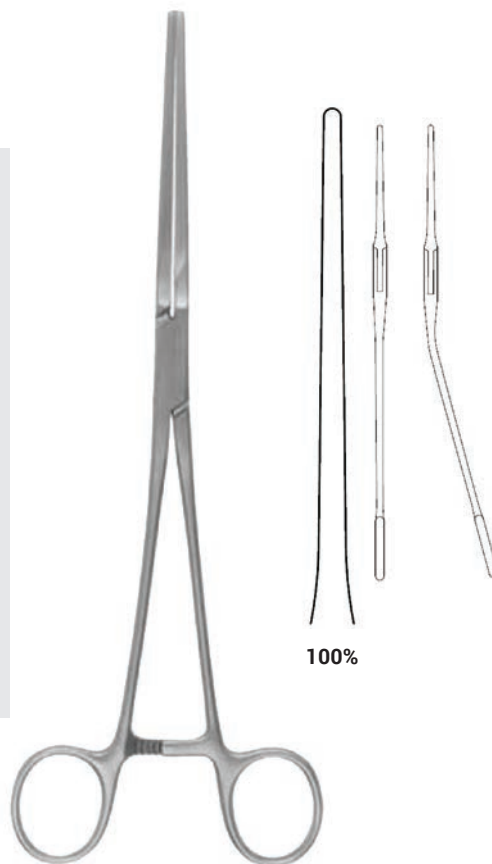

**Cooley Vascular Clamp**

Description	Length	Code
Cooley Vascular Clamp Handles Angled Jaw Straight Jaw 70 mm	20 cm	CC-3850-20
Cooley Vascular Clamp Handles Angled Jaw Straight Jaw 70 mm	24 cm	CC-3851-24

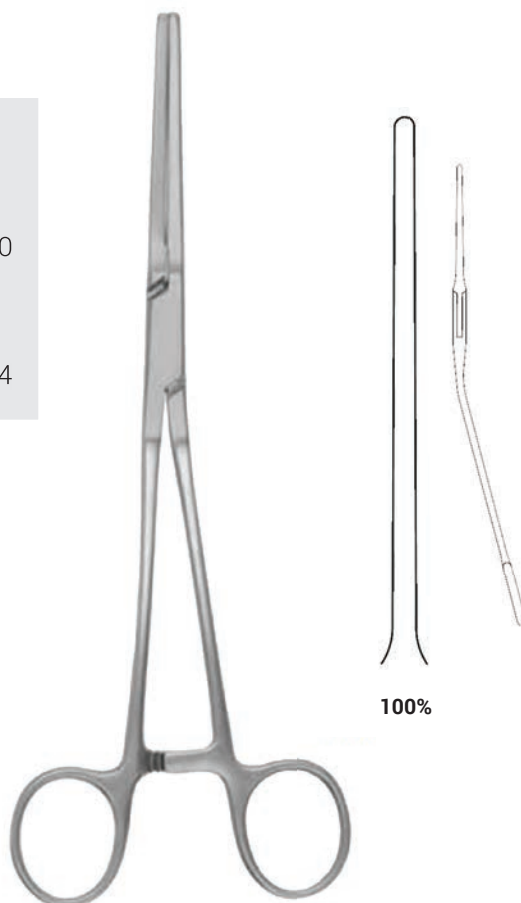

# MICRO VASCULAR CLAMPS

## Cooley Vascular Clamp

Description	Length	Code
Cooley Vascular Clamp Handles Straight Jaw Curved	21 cm	CC-5075-21

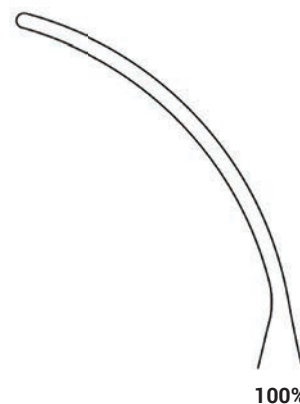

## Cooley Vascular Clamp

Description	Length	Code
Cooley Vascular Clamp Handles Curved Jaw Fully Curved 10 scale line	20 cm	CC-3828-20
Cooley Vascular Clamp Handles Curved Jaw Fully Curved 11 scale line	20 cm	CC-3829-20

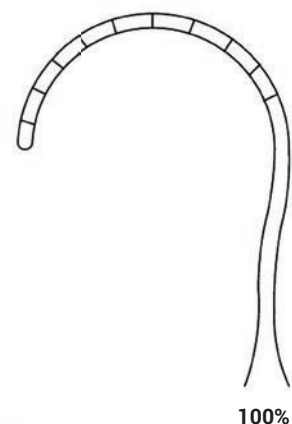

**Cooley Vascular Clamp**

Description	Length	Code
Cooley Vascular Clamp Handles Curved Jaw 60° 40 mm	23 cm	CC-5070-23
Cooley Vascular Clamp Handles Curved Jaw 60° 55 mm	22 cm	CC-5071-22
Cooley Vascular Clamp Handles Curved Jaw 60° 65 mm	23 cm	CC-5072-23
Cooley Vascular Clamp Handles Curved Jaw 60° 110 mm	28 cm	CC-5076-28



**Cooley Vascular Clamp**

Description	Length	Code
Cooley Vascular Clamp Handles Curved Jaw Angled	19 cm	CC-3839-19
Cooley Vascular Clamp Handles Curved Jaw Angled	23 cm	CC-3840-23
Cooley Vascular Clamp Handles Curved Jaw Angled	27 cm	CC-3841-27



# MICRO VASCULAR CLAMPS

## Cooley Hopkins Vascular Clamp

Description	Length	Code
Hopkins Cooley Vascular Clamp Handles Straight Jaw Angled	25 cm	CC-2596-25



## Cooley Satinsky Vascular Clamp

Description	Length	Code
Cooley Satinsky Vascular Clamp Handles Curved Jaw Satinsky 35 mm	20 cm	CC-5051-20
Cooley Satinsky Vascular Clamp Handles Curved Jaw Satinsky 48 mm	21 cm	CC-5052-21
Cooley Satinsky Vascular Clamp Handles Curved Jaw Satinsky 50 mm	22 cm	CC-5053-22
Cooley Satinsky Vascular Clamp Handles Curved Jaw Satinsky 60 mm	23 cm	CC-5054-23
Cooley Satinsky Vascular Clamp Handles Curved Jaw Satinsky 70 mm	27 cm	CC-5055-27



### Cooley Satinsky Vascular Clamp

Description	Length	Code
Cooley Satinsky Vascular Clamp Handles Curved Jaw Satinsky 70 mm	24 cm	CC-5056-24



### Cooley Satinsky Vascular Clamp

Description	Length	Code
Cooley Satinsky Vascular Clamp Handles Straight Jaw Satinsky	24 cm	CC-5079-24



# MICRO VASCULAR CLAMPS

# MICRO VASCULAR CLAMPS

## Cooley Vascular Clamp

Description	Length	Code
Cooley Vascular Clamp Handles/Jaw Fully Curved	20 cm	CC-5057-20
Cooley Vascular Clamp Handles/Jaw Fully Curved	23 cm	CC-5058-23
Cooley Vascular Clamp Handles/Jaw Fully Curved	27 cm	CC-5060-27



## Cooley Vena Cava Vascular Clamp



Ø 6.7-20 FR  
165 mm



Ø 8.0-24 FR  
165 mm



Ø 8.7-26 FR  
184 mm



Ø 9.3-28 FR  
184 mm



Ø 10.0-30 FR  
184 mm



Ø 10.7-32 FR  
184 mm



Ø 11.3-34 FR  
184 mm



Ø 12.0-36 FR  
184 mm



Ø 12.7-38 FR  
184 mm



Ø 13.3-40 FR  
184 mm

### Description

Cooley Vena Cava Vascular Clamp Handles Angled 6.7-20 FR  
 Cooley Vena Cava Vascular Clamp Handles Angled 8.0-24 FR  
 Cooley Vena Cava Vascular Clamp Handles Angled 8.7-26 FR  
 Cooley Vena Cava Vascular Clamp Handles Angled 9.3-28 FR  
 Cooley Vena Cava Vascular Clamp Handles Angled 10.7-32 FR  
 Cooley Vena Cava Vascular Clamp Handles Angled 11.3-34 FR  
 Cooley Vena Cava Vascular Clamp Handles Angled 10.0-30 FR  
 Cooley Vena Cava Vascular Clamp Handles Angled 12.0-36 FR  
 Cooley Vena Cava Vascular Clamp Handles Angled 12.7-38 FR  
 Cooley Vena Cava Vascular Clamp Handles Angled 13.3-40 FR

### Length

16 cm  
16 cm  
18 cm  
18 cm  
18 cm  
18 cm  
18 cm  
18 cm  
18 cm  
18 cm

### Code

CC-0644-16  
CC-0645-16  
CC-0646-18  
CC-0650-18  
CC-0652-18  
CC-0653-18  
CC-0651-18  
CC-0654-18  
CC-0657-18  
CC-0659-18



# MICRO VASCULAR CLAMPS

## Castaneda Neonatal Vascular Clamp

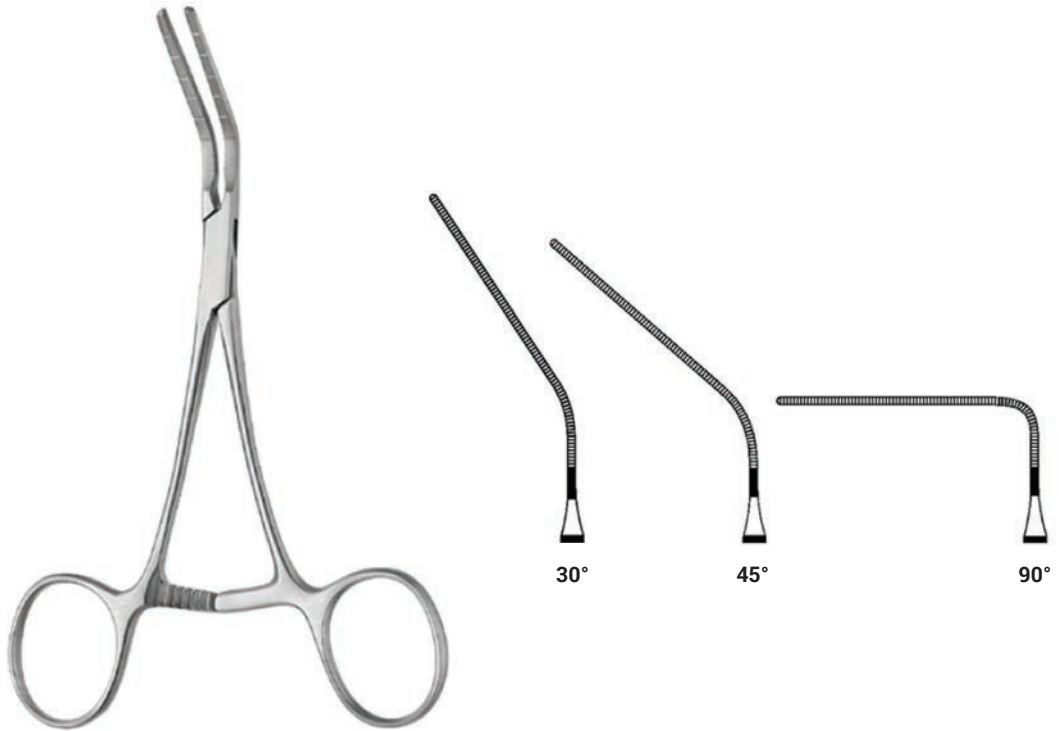

**Description**

Castaneda Neonatal Vascular Clamp  
 Castaneda Neonatal Vascular Clamp  
 Castaneda Neonatal Vascular Clamp

**Length**

11 cm  
 12 cm  
 12 cm

**Code**

CC-1543-11  
 CC-1541-12  
 CC-1542-12

## Castaneda DeBakey Neonatal Vascular Clamp

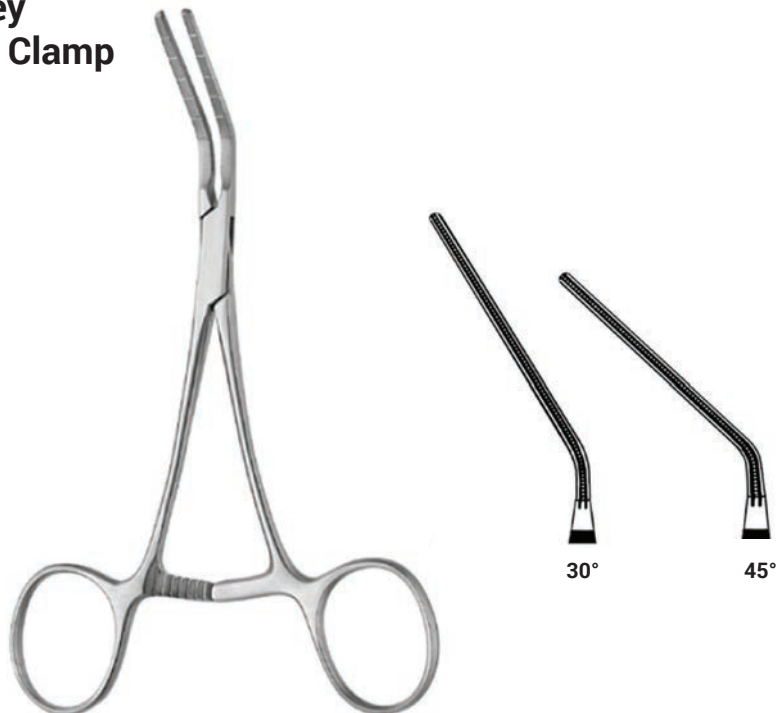

**Description**

Castaneda DeBakey Neonatal Vascular Clamp  
 Castaneda DeBakey Neonatal Vascular Clamp

**Length**

12 cm  
 12 cm

**Code**

CC-1545-12  
 CC-1546-12

### Castaneda Neonatal Vascular Clamp

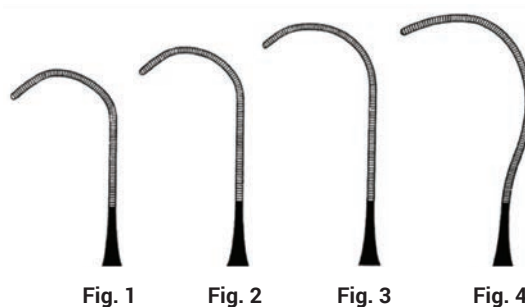

**Description**

Castaneda Neonatal Vascular Clamp  
 Castaneda Neonatal Vascular Clamp  
 Castaneda Neonatal Vascular Clamp  
 Castaneda Neonatal Vascular Clamp

**Length**

**Code**

11 cm CC-1548-11  
 12 cm CC-1549-12  
 12 cm CC-1550-12  
 12 cm CC-1551-12



**MICRO VASCULAR CLAMPS**

## Castaneda Neonatal Vascular Clamp

Description	Length	Code
Castaneda Neonatal Vascular Clamp Handles/Jaw Straight	12 cm	CC-6311-12
Castaneda Neonatal Vascular Clamp Handles Straight/Jaw 15°	12 cm	CC-6332-12
Castaneda Neonatal Vascular Clamp Handles Straight/Jaw 35°	12 cm	CC-6312-12
Castaneda Neonatal Vascular Clamp Handles Straight Jaw Slightly Curved	12 cm	CC-6321-12
Castaneda Neonatal Vascular Clamp Handles Straight Jaw Satinsky 90°	12 cm	CC-6322-12
Castaneda Neonatal Vascular Clamp Handles Straight Jaw Satinsky 90°	12 cm	CC-6323-12

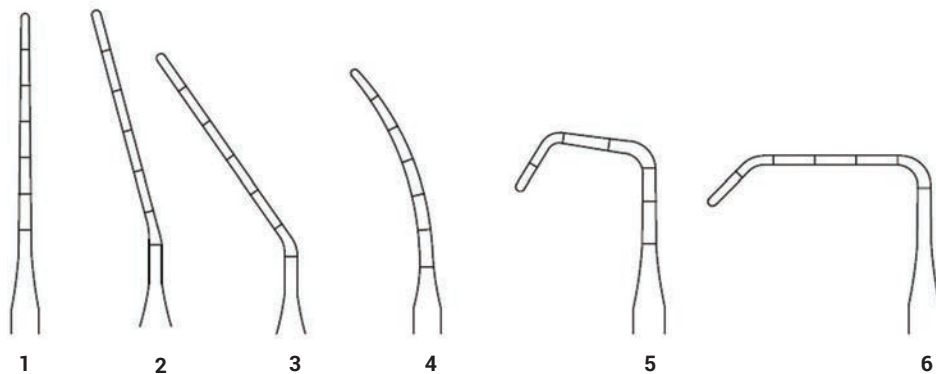

### Castaneda Neonatal Vascular Clamp

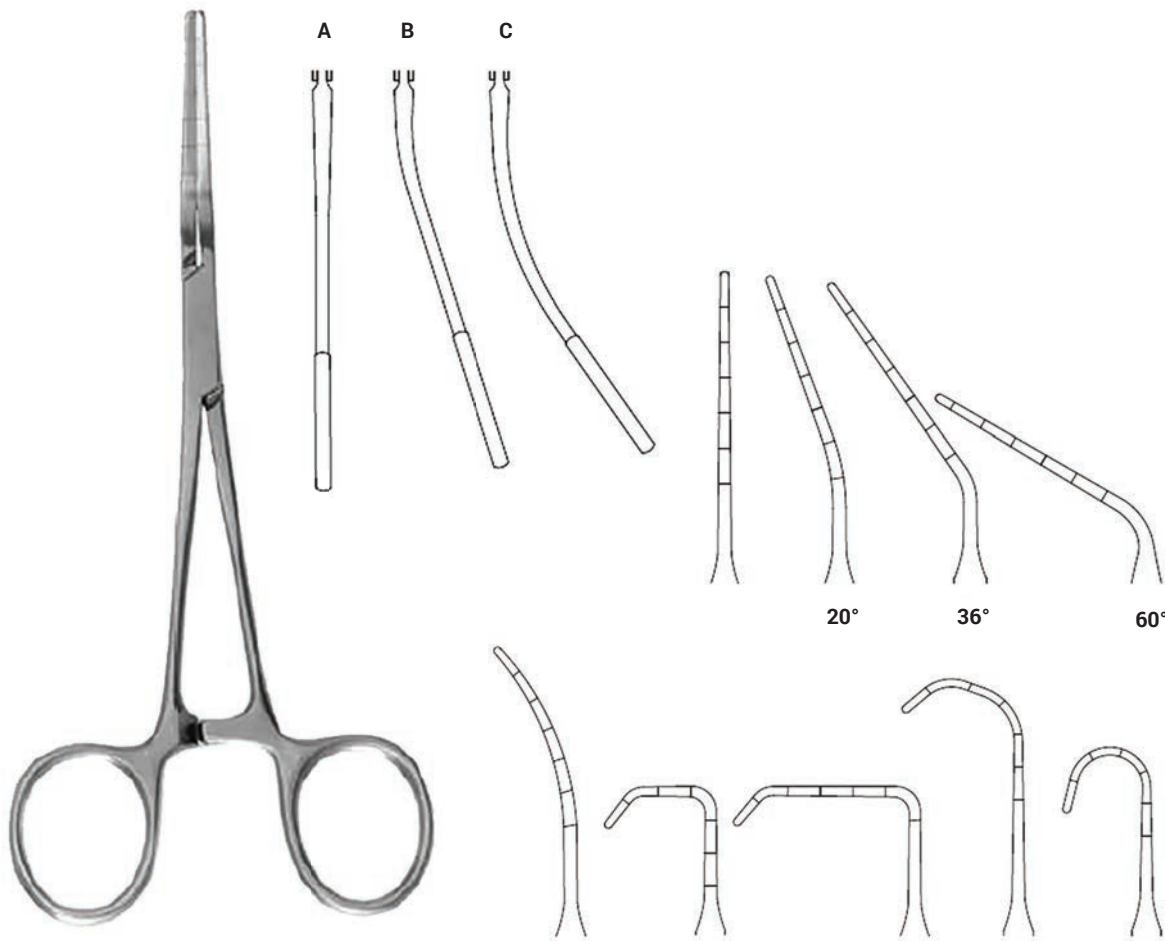

Description	Length	Code
Castaneda Neonatal Vascular Clamp Handles Curved Jaw Straight	12 cm	CC-6360-12
Castaneda Neonatal Vascular Clamp Handles Curved Jaw 15°	12 cm	CC-6361-12
Castaneda Neonatal Vascular Clamp Handles Curved Jaw 30°	12 cm	CC-6362-12
Castaneda Neonatal Vascular Clamp Handles Curved Jaw 50°	12 cm	CC-6316-12
Castaneda Neonatal Vascular Clamp Handles Curved Jaw 60°	12 cm	CC-6363-12
Castaneda Neonatal Vascular Clamp Handles Curved Jaw 85°	12 cm	CC-6314-12
Castaneda Neonatal Vascular Clamp Handles Curved Jaw Slightly Curved	12 cm	CC-6364-12
Castaneda Neonatal Vascular Clamp Handles Curved Jaw Curved	12 cm	CC-6315-12
Castaneda Neonatal Vascular Clamp Handles Curved Jaw Satinsky Small	12 cm	CC-6317-12
Castaneda Neonatal Vascular Clamp Handles Curved Jaw Satinsky Medium	12 cm	CC-6318-12
Castaneda Neonatal Vascular Clamp Handles Curved Jaw Satinsky Large	12 cm	CC-6319-12
Castaneda Neonatal Vascular Clamp Handles Curved Jaw Satinsky 90° Small	12 cm	CC-6365-12
Castaneda Neonatal Vascular Clamp Handles Curved Jaw Satinsky 90° Large	12 cm	CC-6366-12
Castaneda Neonatal Vascular Clamp Handles Curved Jaw Fully Curved 20 mm	12 cm	CC-6367-12
Castaneda Neonatal Vascular Clamp Handles Curved Jaw Fully Curved 15 mm	12 cm	CC-6368-12

MICRO VASCULAR CLAMPS

**Castaneda Paediatric Clamp**

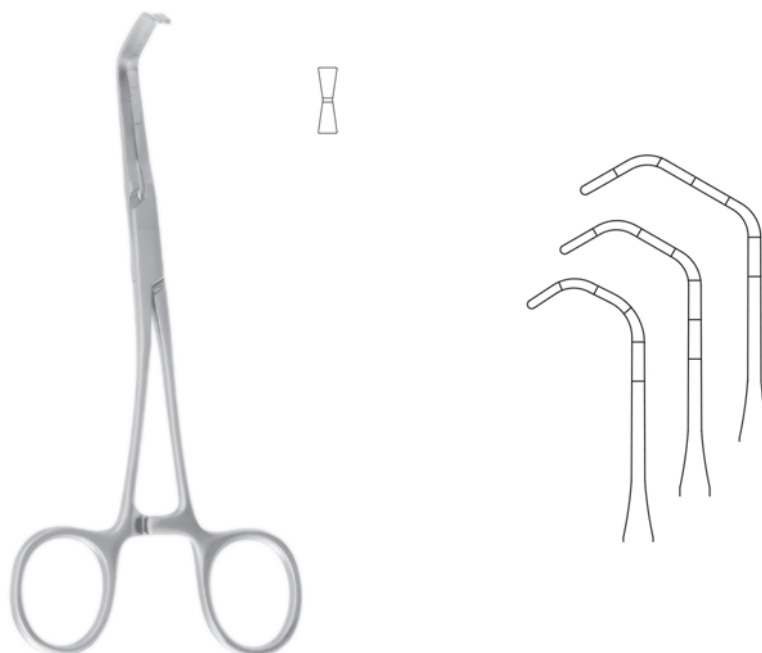

Description	Length	Code
Handles Curved, Jaw Sat. Curved, Small Jaw 18 mm	15 cm	CC-6460-15
Handles Curved, Jaw Sat. Curved, Medium Jaw 20 mm	15 cm	CC-6437-15
Handles Curved, Jaw Sat. Curved, Large Jaw 23 mm	15 cm	CC-6461-15

**Castaneda Paediatric Clamp**

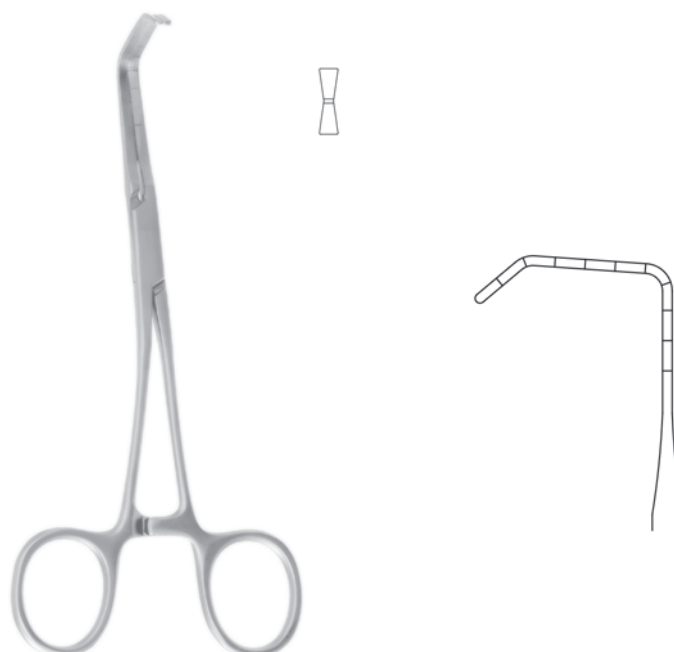

Description	Length	Code
Castaneda Paediatric Clamp Handles Curved, Jaw Sat. 86°	16 cm	CC-6403-16

**Castaneda Paediatric Clamp**

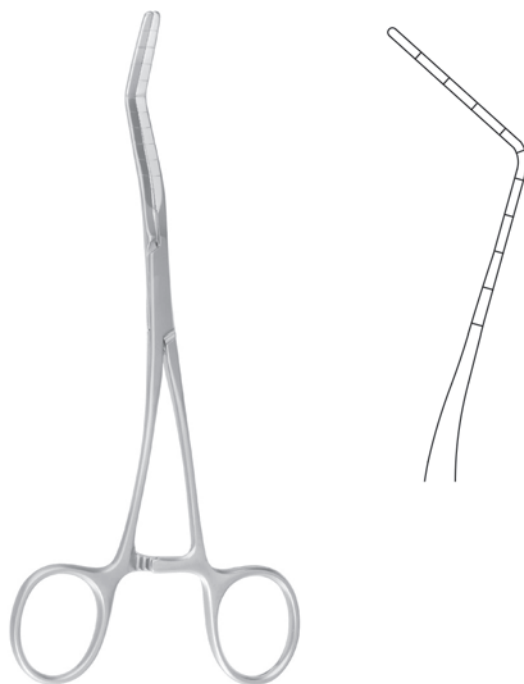

**Description**

Handles Curved, Jaw Ang. Backwards, B Scale Lines

**Length**

17 cm

**Code**

CC-4859-17

**Castaneda Paediatric Clamp**



**Description**

Castaneda Paediatric Clamp Handles Curved, Jaw Sat. 65°

**Length**

17 cm

**Code**

CC-6404-17

**Titanium Micro Kitzmiller Neonatal Vascular Clamp**



**Description**

Titanium Micro Kitzmiller Neonatal Vascular Clamp Jaw Left 23 mm  
 Titanium Micro Kitzmiller Neonatal Vascular Clamp Jaw Right 23 mm

**Length Code**

11 cm CC-2330-11  
 11 cm CC-2331-11

**DeBakey Titanium Neonatal Vascular Clamp**

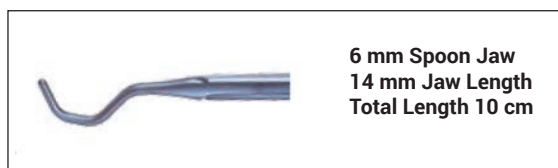

**Description**

DeBakey Titanium Neonatal Vascular Clamp Slightly Angled Shanks 14 mm Jaw  
 DeBakey Titanium Neonatal Vascular Clamp Straight Shanks 14 mm Jaw  
 DeBakey Titanium Neonatal Vascular Clamp Slightly Angled Shanks 16 mm Jaw  
 DeBakey Titanium Neonatal Vascular Clamp Slightly Angled Shanks 22 mm Jaw  
 DeBakey Titanium Neonatal Vascular Clamp Slightly Angled Shanks 20 mm Jaw  
 DeBakey Titanium Neonatal Vascular Clamp Straight Shanks 26 mm Jaw

**Length Code**

10 cm CC-2332-10  
 10 cm CC-2333-10  
 10 cm CC-2334-10  
 12 cm CC-2335-12  
 12 cm CC-2336-12  
 12 cm CC-2337-12

### DeBakey Titanium Neonatal Vascular Clamp

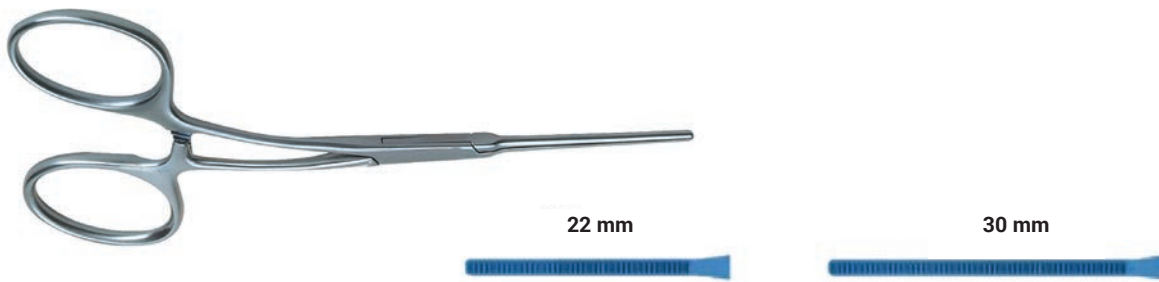

**Description**

Description	Length	Code
DeBakey Titanium Neonatal Vascular Clamp Angled Shanks 22 mm Jaw	10 cm	CC-2322-10
DeBakey Titanium Neonatal Vascular Clamp Straight Shanks 30 mm Jaw	12 cm	CC-2320-12
DeBakey Titanium Neonatal Vascular Clamp Slightly Angled Shanks 30 mm Jaw	12 cm	CC-2321-12
DeBakey Titanium Neonatal Vascular Clamp Angled Shanks 30 mm Jaw	12 cm	CC-2323-12

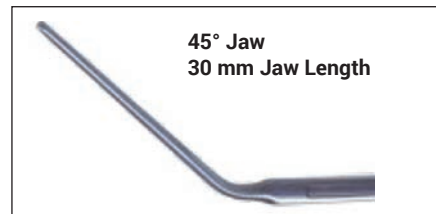
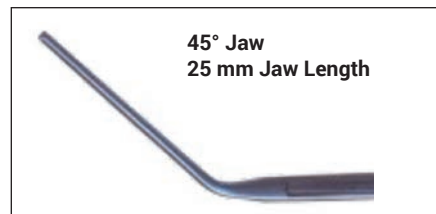

### DeBakey Titanium Neonatal Vascular Clamp

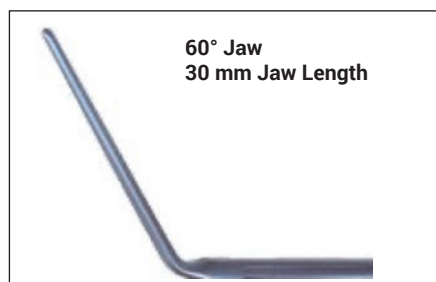
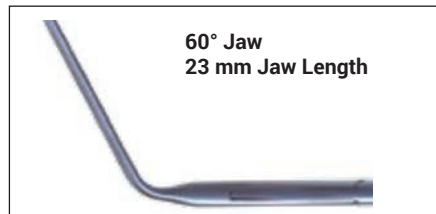

**Description**

Description	Length	Code
DeBakey Titanium Neonatal Vascular Clamp Straight Shanks 45° 25 mm Jaw	10 cm	CC-2324-10
DeBakey Titanium Neonatal Vascular Clamp Straight Shanks 45° 30 mm Jaw	12 cm	CC-2325-12
DeBakey Titanium Neonatal Vascular Clamp Straight Shanks 60° 23 mm Jaw	10 cm	CC-2326-10
DeBakey Titanium Neonatal Vascular Clamp Straight Shanks 60° 30 mm Jaw	12 cm	CC-2327-12
DeBakey Titanium Neonatal Vascular Clamp Straight Shanks 90° 23 mm Jaw	10 cm	CC-2328-10
DeBakey Titanium Neonatal Vascular Clamp Straight Shanks 90° 30 mm Jaw	12 cm	CC-2329-12

# MICRO VASCULAR CLAMPS

DeBakey Ultralight Paediatric Vascular Clamp 1.4 mm Jaw Tip

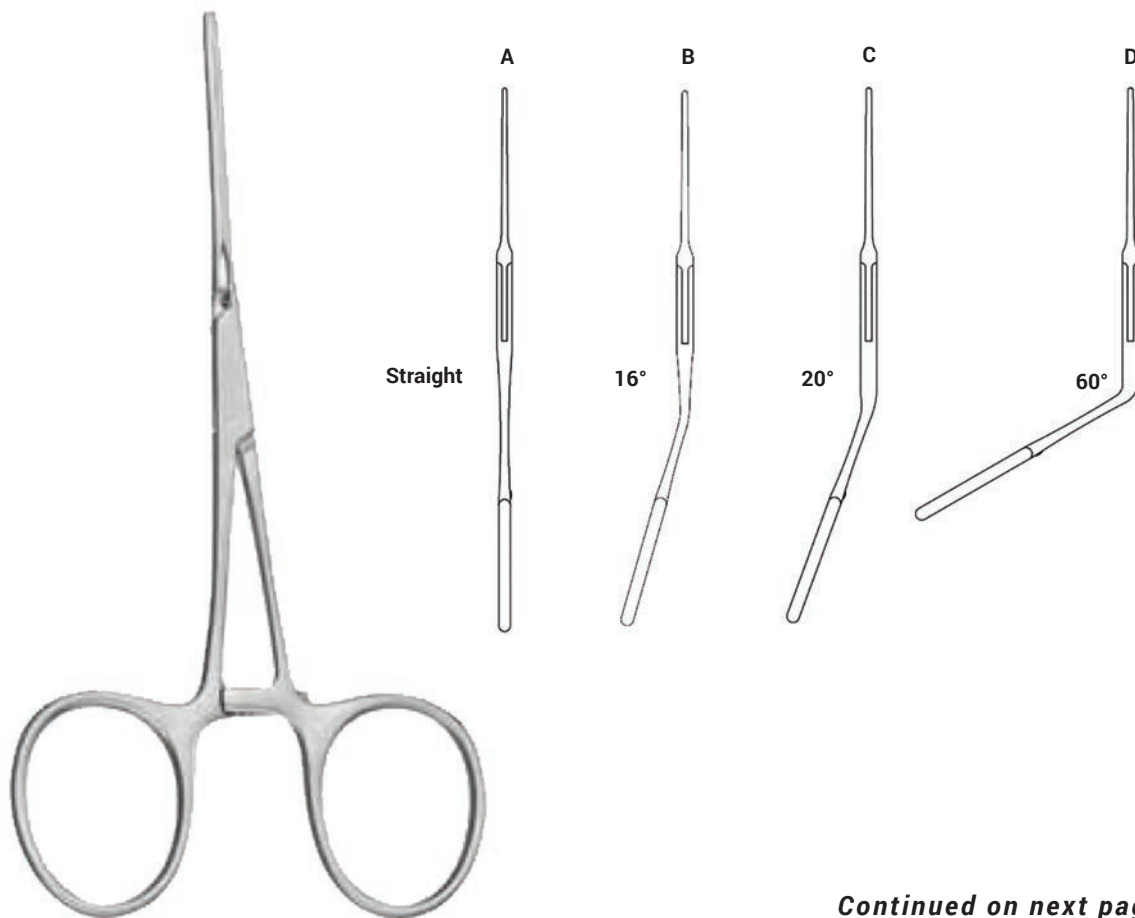

*Continued on next page*

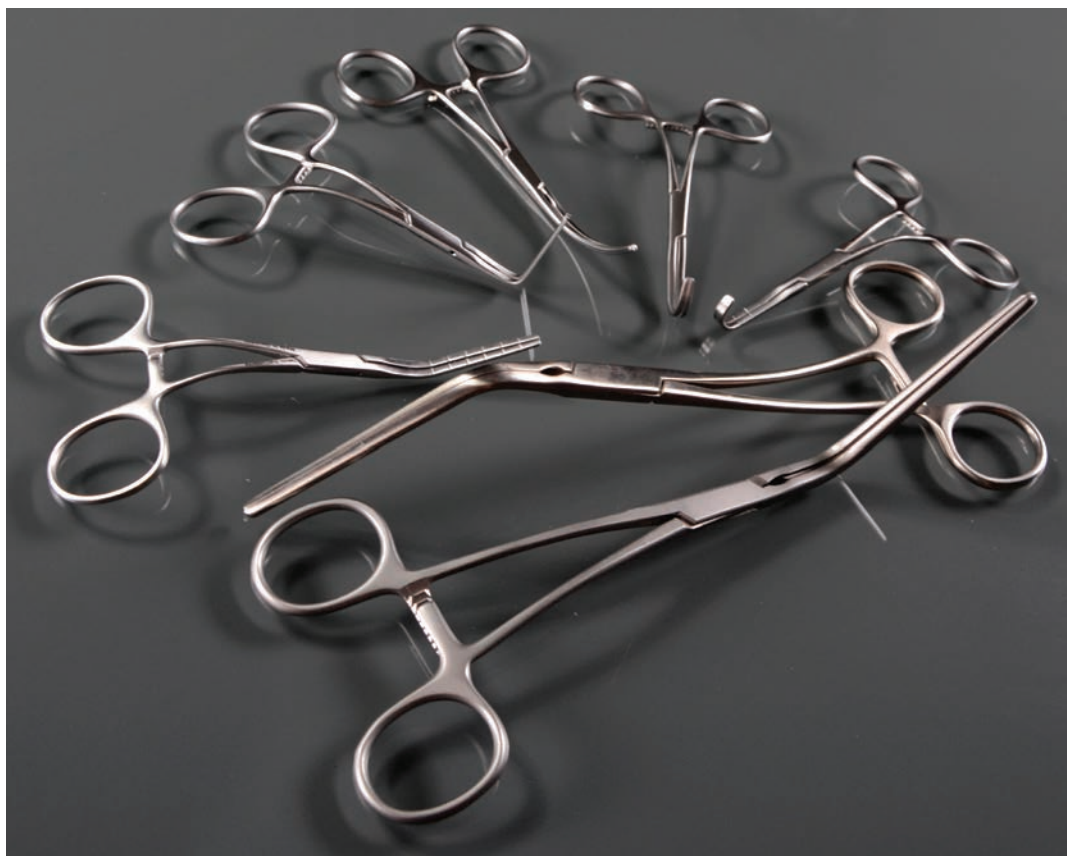

DeBakey Ultralight Paediatric Vascular Clamp 1.4 mm Jaw Tip

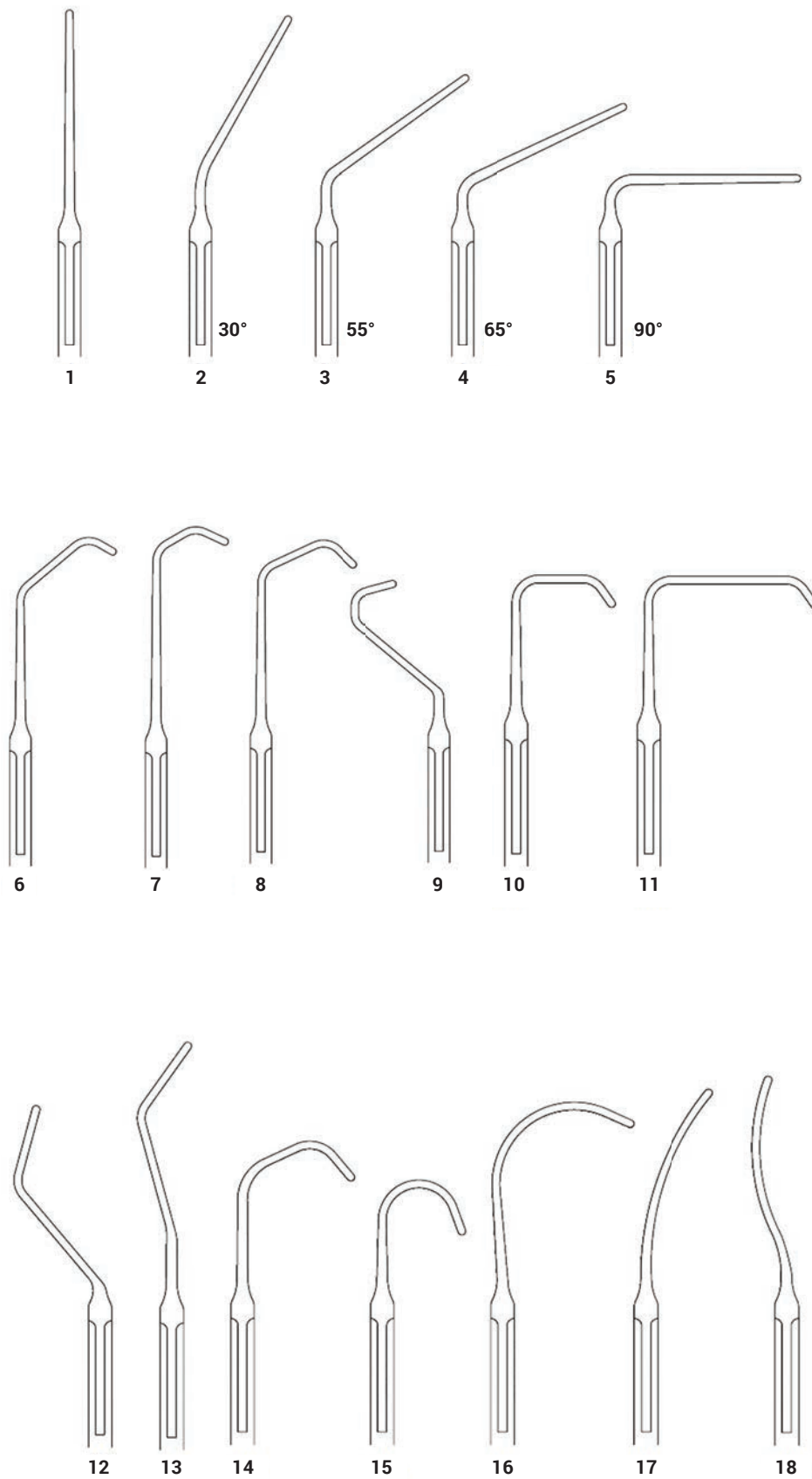

MICRO VASCULAR CLAMPS

## DeBakey Ultralight Paediatric Vascular Clamp 1.4 mm Jaw Tip

A	Straight Handle DeBakey	B	16° Angled Handle	C	20° Angled Handle	D	60° Angled Handle
1	CC-2420-10	1	CC-2400-10	1	CC-2440-12	1	CC-2460-12
2	CC-2421-10	2	CC-2401-10	2	CC-2441-12	2	CC-2461-12
3	CC-2422-10	3	CC-2402-10	3	CC-2442-12	3	CC-2462-12
4	CC-2423-10	4	CC-2403-10	4	CC-2443-12	4	CC-2463-12
5	CC-2424-10	5	CC-2404-10	5	CC-2444-12	5	CC-2464-12
6	CC-2425-10	6	CC-2405-10	6	CC-2445-12	6	CC-2465-12
7	CC-2426-10	7	CC-2406-10	7	CC-2446-12	7	CC-2466-12
8	CC-2427-10	8	CC-2407-10	8	CC-2447-12	8	CC-2467-12
9	CC-2428-10	9	CC-2408-10	9	CC-2448-12	9	CC-2468-12
10	CC-2429-10	10	CC-2409-10	10	CC-2449-12	10	CC-2469-12
11	CC-2430-10	11	CC-2410-10	11	CC-2450-12	11	CC-2470-12
12	CC-2431-10	12	CC-2411-10	12	CC-2451-12	12	CC-2471-12
13	CC-2432-10	13	CC-2412-10	13	CC-2452-12	13	CC-2472-12
14	CC-2433-10	14	CC-2413-10	14	CC-2453-12	14	CC-2473-12
15	CC-2434-10	15	CC-2414-10	15	CC-2454-12	15	CC-2474-12
16	CC-2435-10	16	CC-2415-10	16	CC-2455-12	16	CC-2475-12
17	CC-2436-10	17	CC-2416-10	17	CC-2456-12	17	CC-2476-12
18	CC-2437-10	18	CC-2417-10	18	CC-2457-12	18	CC-2477-12



DeBakey Ring Handle Bulldog Clamp Delicate, Jaw Tip: Ø 1,6 mm

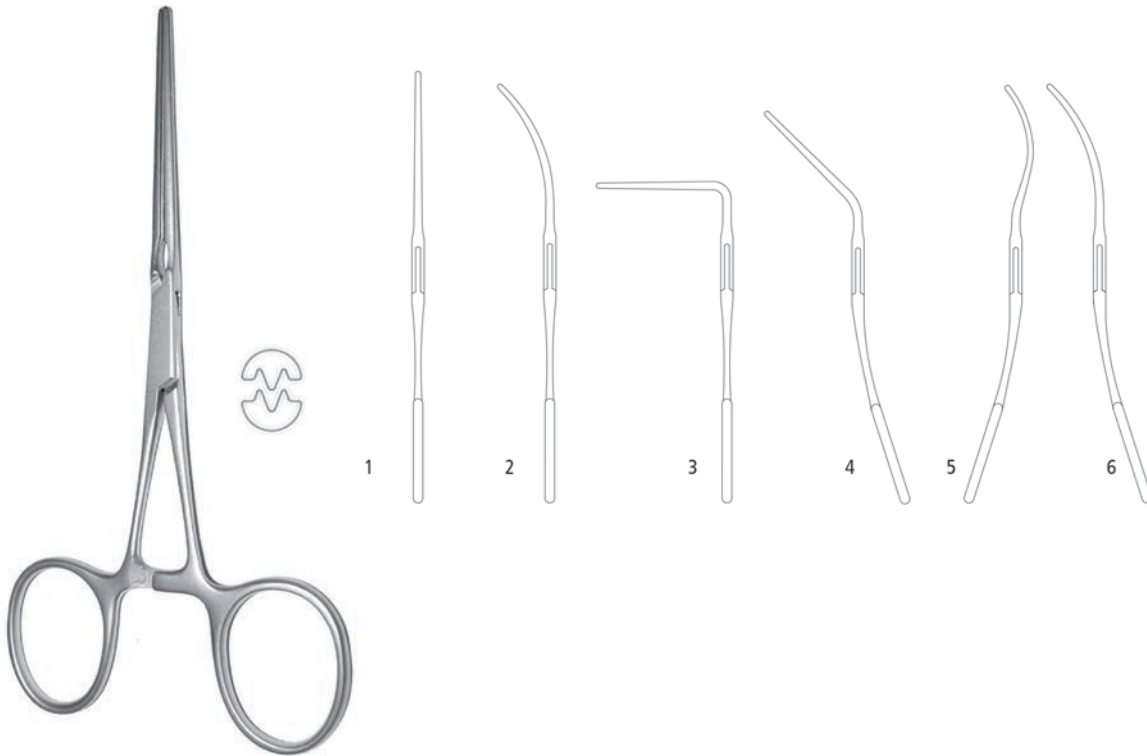

**Description**

Handles Straight, Jaw 90°

Handles Curved, Jaw 45°

Handles Curved, Jaw Spoon Shaped

Handles Curved, Jaw Slightly Curved, S-Form

Handles Straight, Jaw Straight

Handles Straight, Jaw Slightly Curved

**Length**

10 cm

12 cm

13 cm

13 cm

13 cm

13 cm

**Code**

CC-2192-10

CC-2189-12

CC-2194-12

CC-2195-12

CC-2182-13

CC-2186-13



**MICRO VASCULAR CLAMPS**

## DeBakey Ring Handle Bulldog Clamp Delicate, Jaw Tip: Ø 1,6 mm

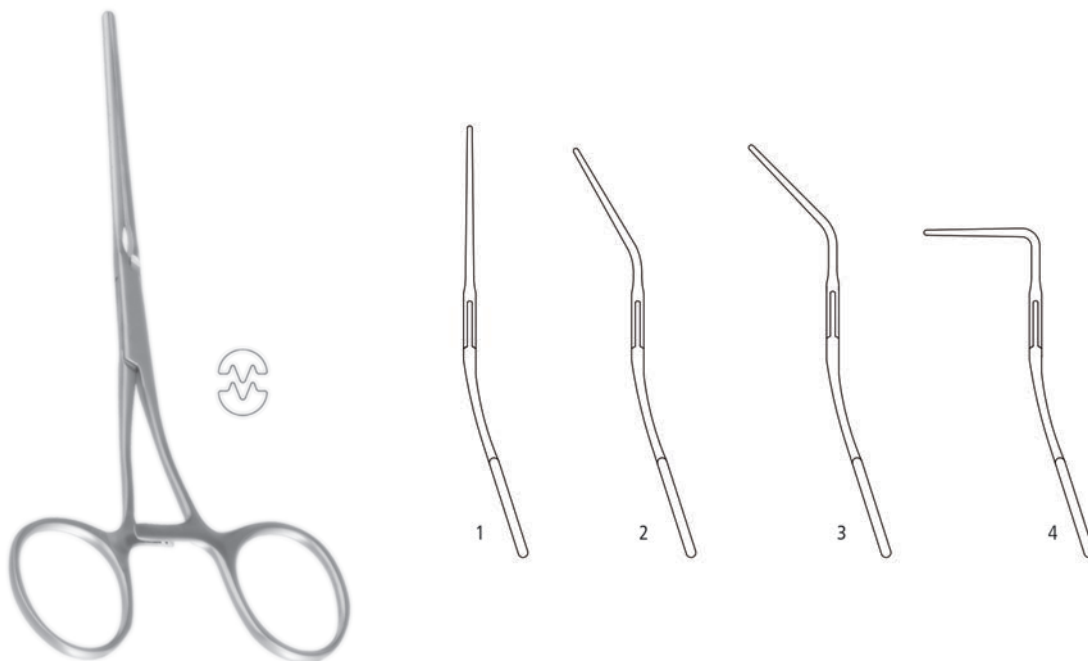
**Description**

Handles Curved, 7 Scale lines on Jaw, Jaw 90°

**Length**

10 cm

**Code**

CC-2223-10

Handles Curved, 7 Scale lines on Jaw, Jaw 30°

12 cm

CC-2221-12

Handles Curved, 7 Scale lines on Jaw, Jaw Straight

13 cm

CC-2220-13

Handles Curved, 7 Scale lines on Jaw, Jaw 45°

13 cm

CC-2222-13



## DeBakey Vascular Clamp

Description	Length	Code
DeBakey Vascular Clamp Handles Curved Jaw Angled 90°	13 cm	CC-3739-13
DeBakey Vascular Clamp Handles Curved Jaw Angled 60°	15 cm	CC-3737-15
DeBakey Vascular Clamp Handles Curved Jaw Angled 30°	16 cm	CC-3735-16



# MICRO VASCULAR CLAMPS

## DeBakey Satinsky Paediatric Vascular Clamp

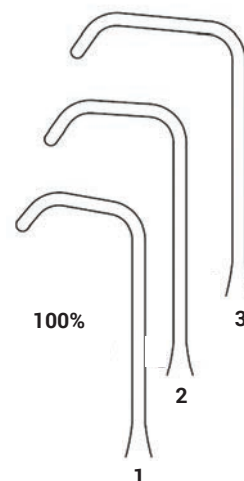

### Description

DeBakey Satinsky Paediatric Vascular Clamp Handles Curved Jaw 14 mm  
 DeBakey Satinsky Paediatric Vascular Clamp Handles Curved Jaw 18 mm  
 DeBakey Satinsky Paediatric Vascular Clamp Handles Curved Jaw 23 mm

### Length

14 cm  
 14 cm  
 14 cm

### Code

CC-2196-14  
 CC-2197-14  
 CC-2198-14

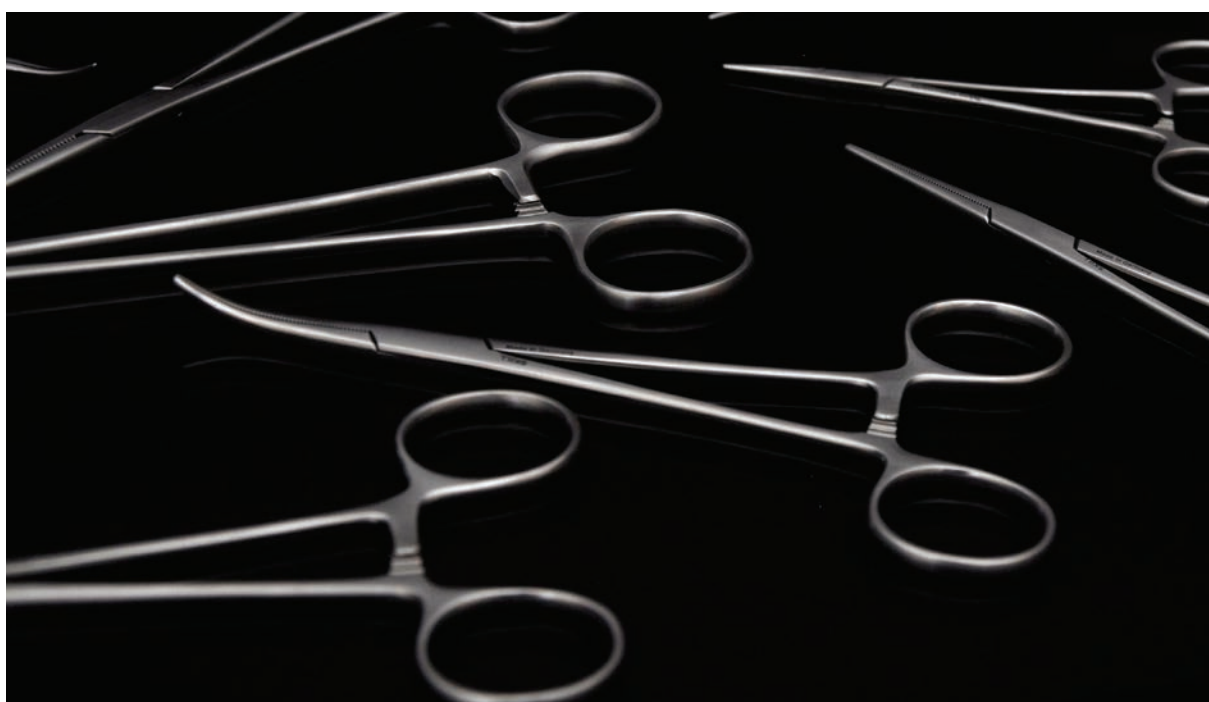

### DeBakey Paediatric Vascular Clamp

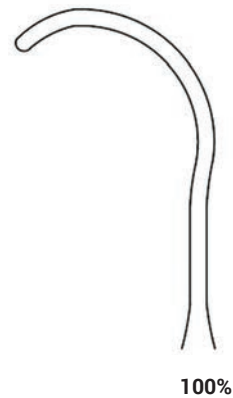

#### Description

DeBakey Paediatric Vascular Clamp Handles Curved Jaw S-form 25 mm

#### Length

14 cm

#### Code

CC-2199-14

### DeBakey Mini Beck Paediatric Vascular Clamp

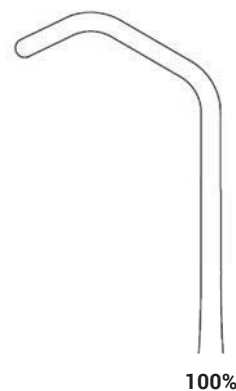

#### Description

DeBakey Mini Beck Paediatric Vascular Clamp Handles Straight Jaw 65°

#### Length

16 cm

#### Code

CC-3750-16

# MICRO VASCULAR CLAMPS

### DeBakey Peripheral Vascular Clamp

Description	Length	Code
DeBakey Peripheral Vascular Clamp Handles Straight Jaw Curved	16 cm	CC-2550-16

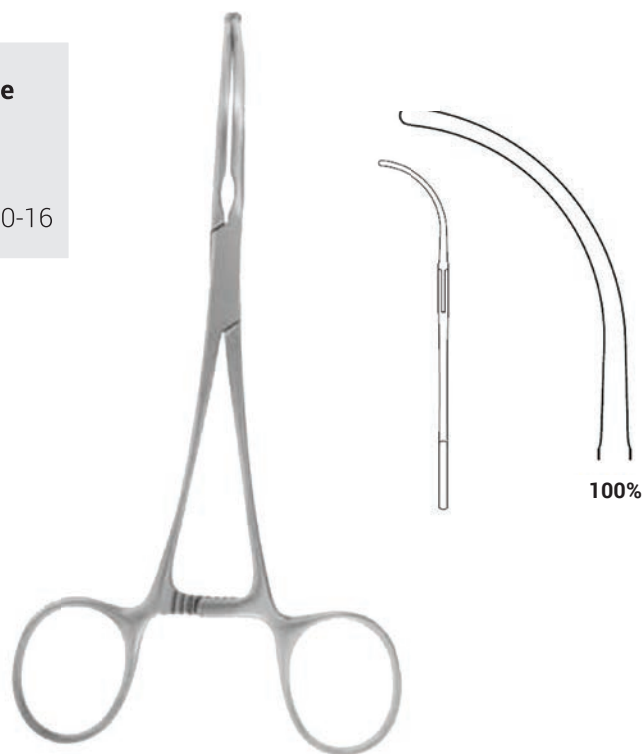

### DeBakey Vascular Clamp

Description	Length	Code
DeBakey Vascular Clamp Handles Curved Jaw 57° 53 mm	17 cm	CC-2535-17



### DeBakey Glover Vascular Clamp

Description	Length	Code
DeBakey Glover Vascular Clamp Handles Straight Jaw Straight	17 cm	CC-3752-17
DeBakey Glover Vascular Clamp Handles Straight Jaw Curved	17 cm	CC-3754-17



### DeBakey Aorta Clamp

Description	Length	Code
DeBakey Diethrich Aorta Clamp Handles Angled Jaw Satinsky	17 cm	CC-2587-17
DeBakey Ochsner Aorta Clamp Handles Angled Jaw Satinsky	22 cm	CC-2586-22

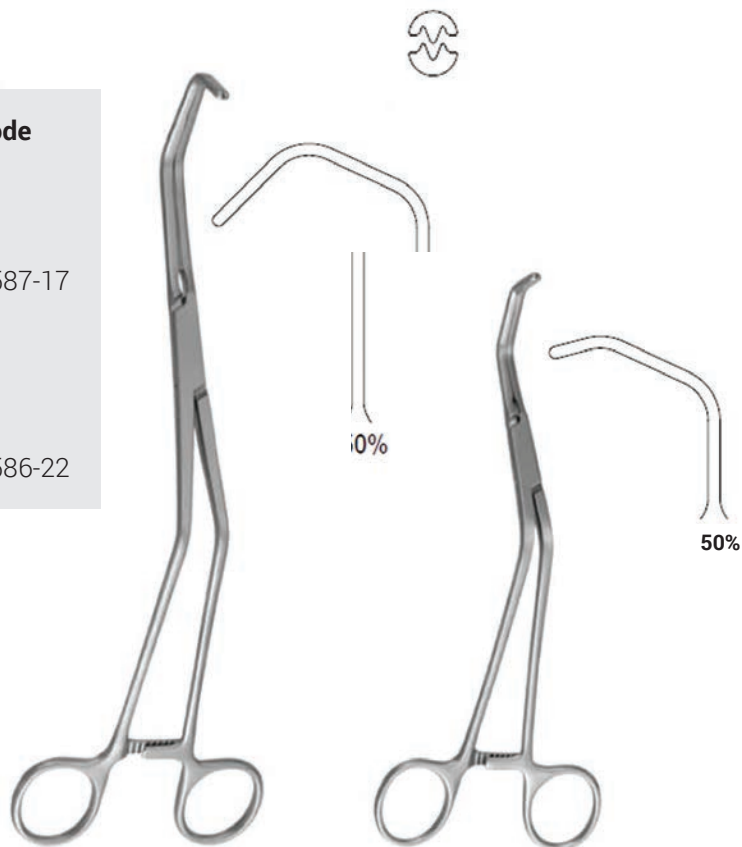

### DeBakey Derra Paediatric Vascular Clamp

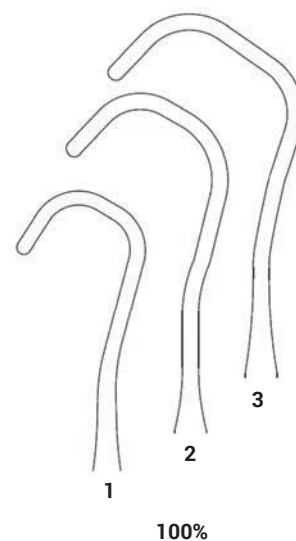

#### Description

DeBakey Derra Paediatric Vascular Clamp Handles Curved Jaw Small

DeBakey Derra Paediatric Vascular Clamp Handles Curved Jaw Medium

DeBakey Derra Paediatric Vascular Clamp Handles Curved Jaw Large

#### Length

17 cm

17 cm

17 cm

#### Code

CC-3135-17

CC-3136-17

CC-3137-17



### DeBakey Multi-Purpose Vascular Clamp

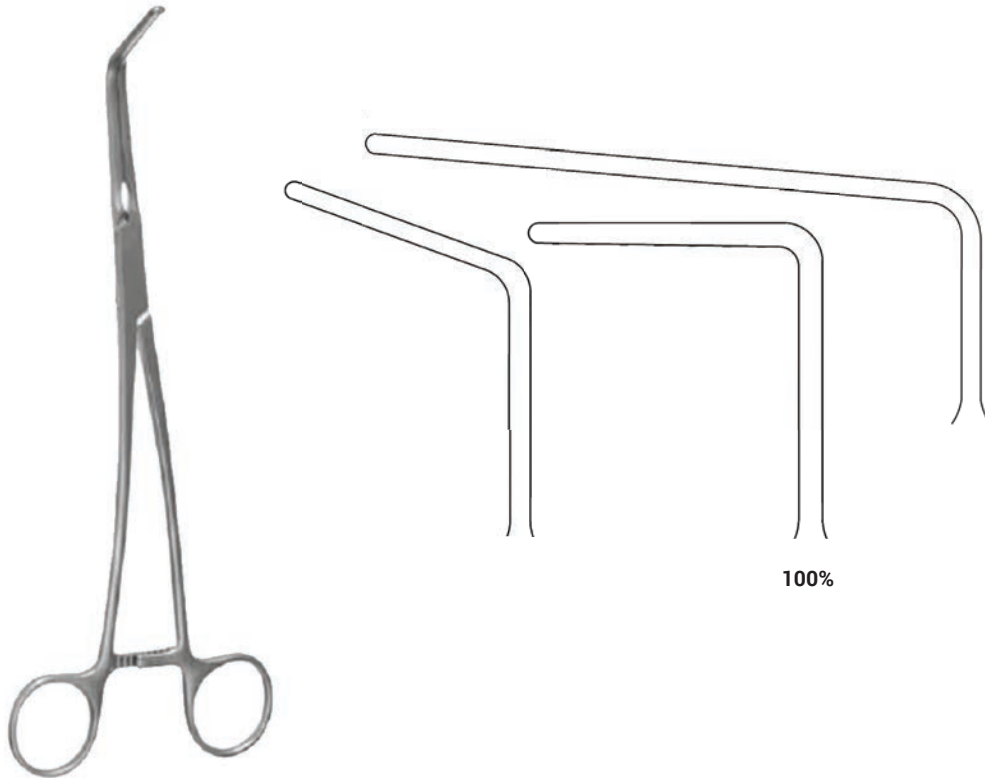

**Description**

Description	Length	Code
DeBakey Multi-Purpose Vascular Clamp Handles Curved Jaw 90° 65 mm	18 cm	CC-2692-18
DeBakey Multi-Purpose Vascular Clamp Handles Curved Jaw 90° 75 mm	19 cm	CC-2694-19
DeBakey Multi-Purpose Vascular Clamp Handles Curved Jaw 90° 45 mm	22 cm	CC-2690-22
DeBakey Multi-Purpose Vascular Clamp Handles Curved Jaw 70°	23 cm	CC-2680-23
DeBakey Multi-Purpose Vascular Clamp Handles Curved Jaw 95°	24 cm	CC-2696-24



# MICRO VASCULAR CLAMPS

**DeBakey S-form Peripheral Vascular Clamp**

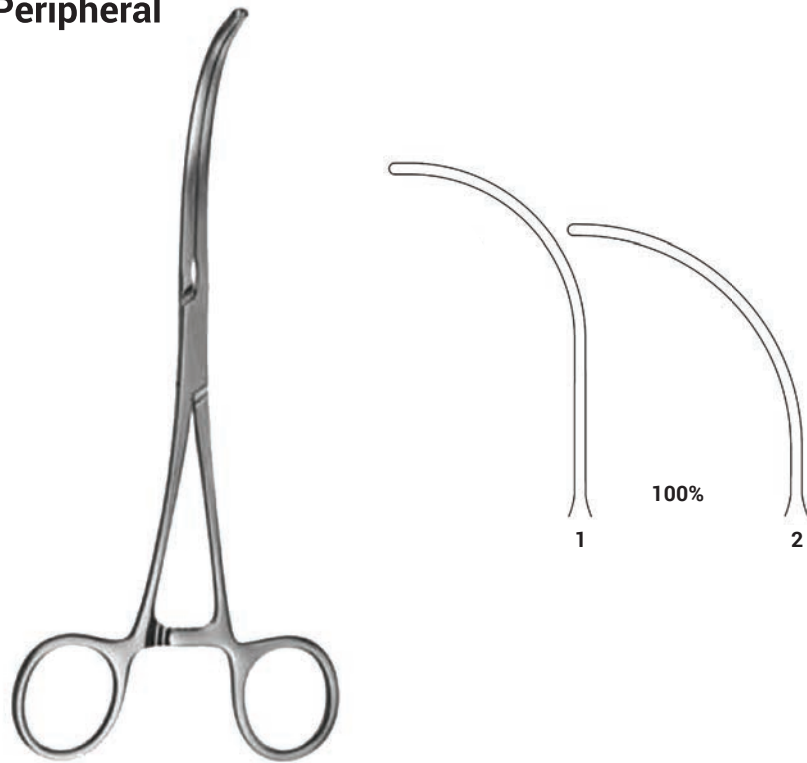

Description	Length	Code
DeBakey S-form Peripheral Vascular Clamp Handles Curved Jaw Curved	19 cm	CC-2540-19
DeBakey S-form Peripheral Vascular Clamp Handles Curved Jaw Curved	19 cm	CC-2545-19

**DeBakey Coarctation Vascular Clamp**

Description	Length	Code
DeBakey Coarctation Vascular Clamp Handles Straight Jaw Straight 40 mm	20 cm	CC-2800-20
DeBakey Coarctation Vascular Clamp Handles Curved Jaw Straight 40 mm	20 cm	CC-2802-20
DeBakey Coarctation Vascular Clamp Handles Curved Jaw Straight 70 mm	22 cm	CC-2503-22
DeBakey Coarctation Vascular Clamp Handles Straight Jaw Straight 70 mm	23 cm	CC-2500-23
DeBakey Coarctation Vascular Clamp Handles Curved Jaw Straight 80 mm	25 cm	CC-2867-25
DeBakey Coarctation Vascular Clamp Handles Straight Jaw Straight 80 mm	26 cm	CC-2865-26

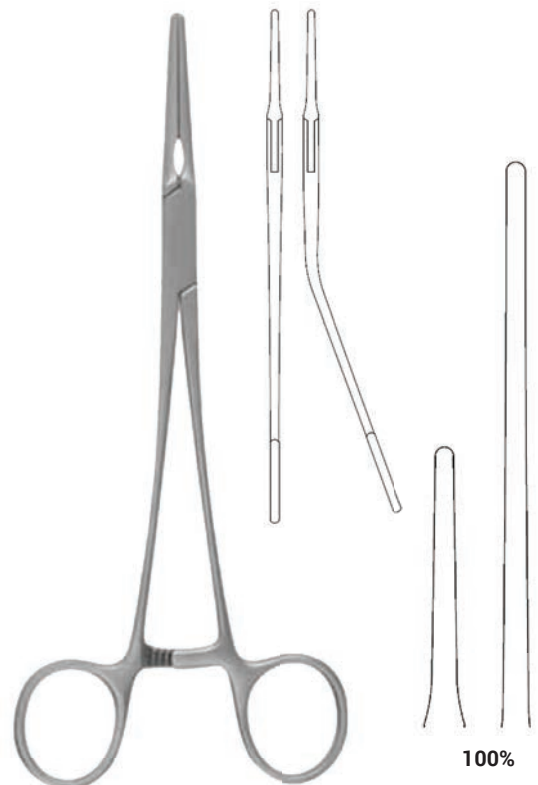

**DeBakey Multi-Purpose Vascular Clamp**

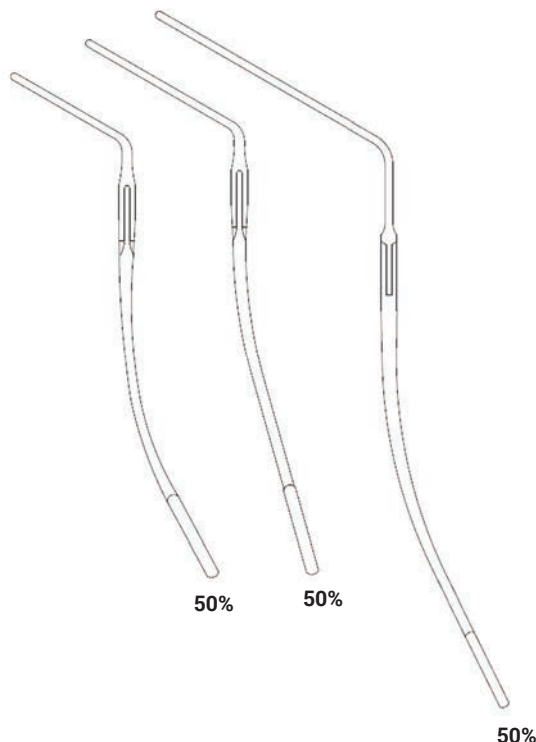

**Description**

DeBakey Multi-Purpose Vascular Clamp Handles Curved Jaw 60° 55 mm  
 DeBakey Multi-Purpose Vascular Clamp Handles Curved Jaw 60° 70 mm  
 DeBakey Multi-Purpose Vascular Clamp Handles Curved Jaw 60° 105 mm

**Length**

20 cm  
 22 cm  
 28 cm

**Code**

CC-2682-20  
 CC-2684-22  
 CC-2686-28

**DeBakey Beck Vena Cava Vascular Clamp**

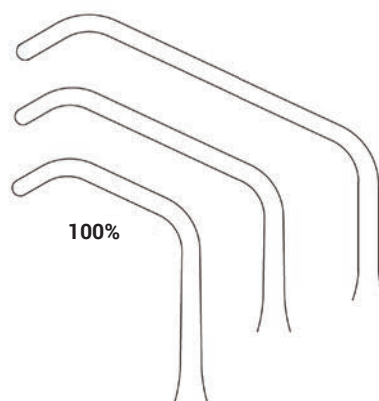

**Description**

DeBakey Beck Vena Cava Vascular Clamp Handles Curved Jaw 65° 30 mm  
 DeBakey Beck Vena Cava Vascular Clamp Handles Curved Jaw 65° 65 mm  
 DeBakey Beck Vena Cava Vascular Clamp Handles Curved Jaw 65° 45 mm

**Length**

20 cm  
 20 cm  
 21 cm

**Code**

CC-3100-20  
 CC-3104-20  
 CC-3102-21

## DeBakey Satinsky Vascular Clamp

**Description**

DeBakey Satinsky Vascular Clamp Handles Curved Jaw 38 mm  
 DeBakey Satinsky Vascular Clamp Handles Curved Jaw 48 mm  
 DeBakey Satinsky Vascular Clamp Handles Curved Jaw 55 mm  
 DeBakey Satinsky Vascular Clamp Handles Curved Jaw 60 mm  
 DeBakey Satinsky Vascular Clamp Handles Curved Jaw 75 mm

**Length**

20 cm  
 25 cm  
 25 cm  
 26 cm  
 27 cm

**Code**

CC-2660-20  
 CC-2662-25  
 CC-2664-25  
 CC-2666-26  
 CC-2668-27

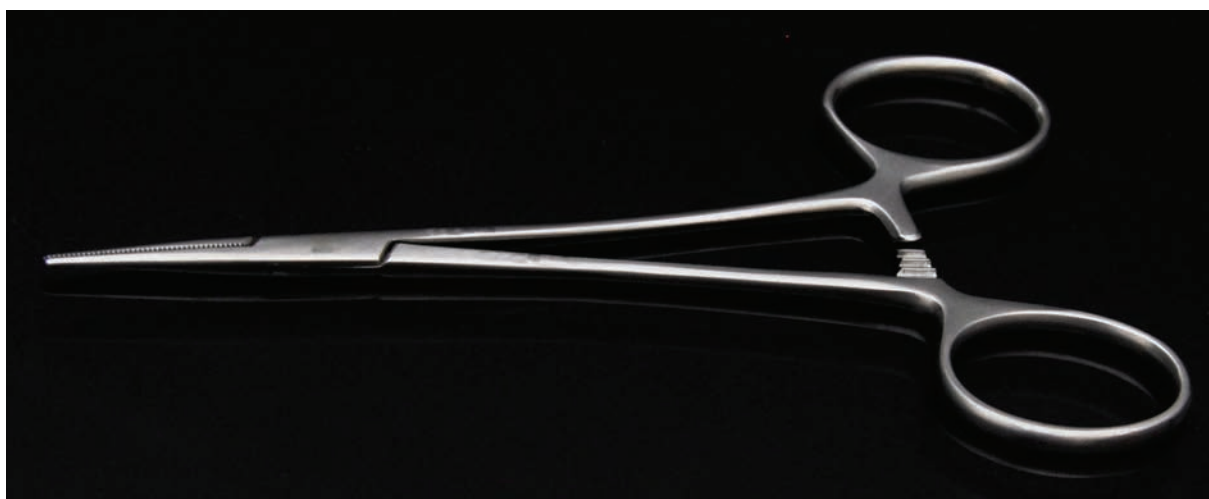

### DeBakey Vascular Clamp

Description	Length	Code
DeBakey Vascular Clamp Handles Straight Jaw Curved	21 cm	CC-1561-21
DeBakey Vascular Clamp Handles Straight Jaw Curved	22 cm	CC-1562-22

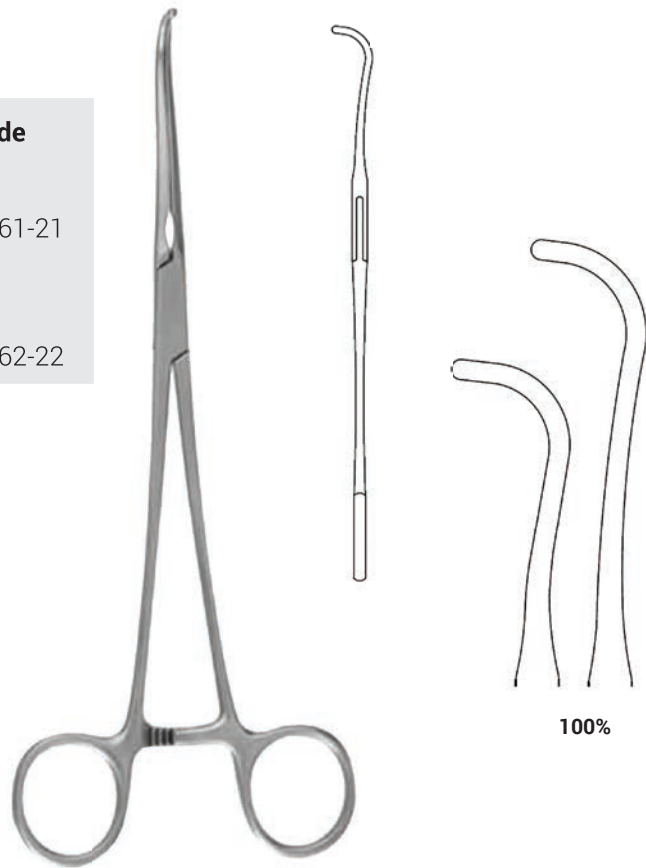

### DeBakey Patent Ductus Vascular Clamp

Description	Length	Code
DeBakey Vascular Clamp Handles Straight Jaw Straight	21 cm	CC-2510-21
DeBakey Vascular Clamp Handles Curved Jaw Straight	21 cm	CC-2513-21



# MICRO VASCULAR CLAMPS

## DeBakey Glover Vascular Clamp

Description	Length	Code
DeBakey Glover Vascular Clamp Handles Straight Jaw Curved	21 cm	CC-2825-21
DeBakey Glover Vascular Clamp Handles Straight Jaw Straight	22 cm	CC-2810-22
DeBakey Glover Vascular Clamp Handles Angled Jaw Straight	22 cm	CC-2812-22
DeBakey Glover Vascular Clamp Handles Straight Jaw Spoon Shaped	22 cm	CC-2840-22
DeBakey Glover Vascular Clamp Handles Straight Jaw Curved	23 cm	CC-2827-23
DeBakey Glover Vascular Clamp Handles Straight Jaw Spoon Shaped	25 cm	CC-2842-25

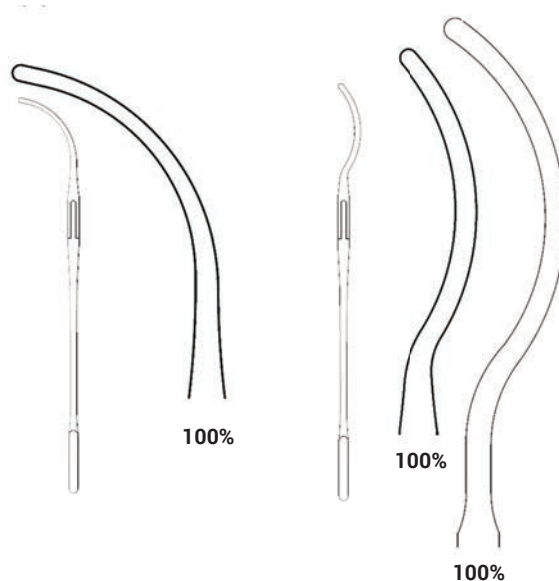
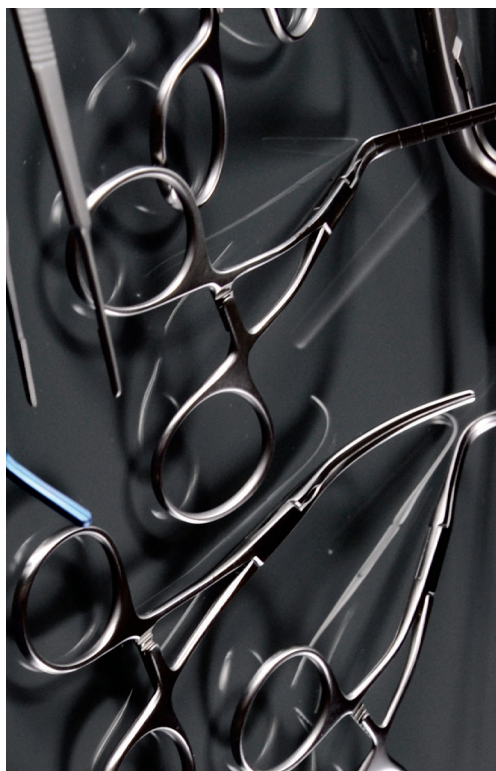

### DeBakey Potts Vascular Clamp

Description	Length	Code
DeBakey Potts Vascular Clamp Handles Straight Jaw 25°	22 cm	CC-2504-22

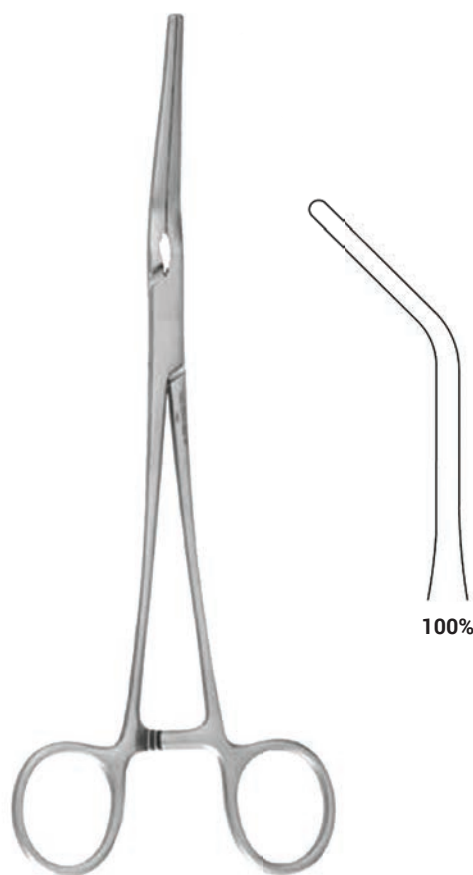

### DeBakey Resection Clamp

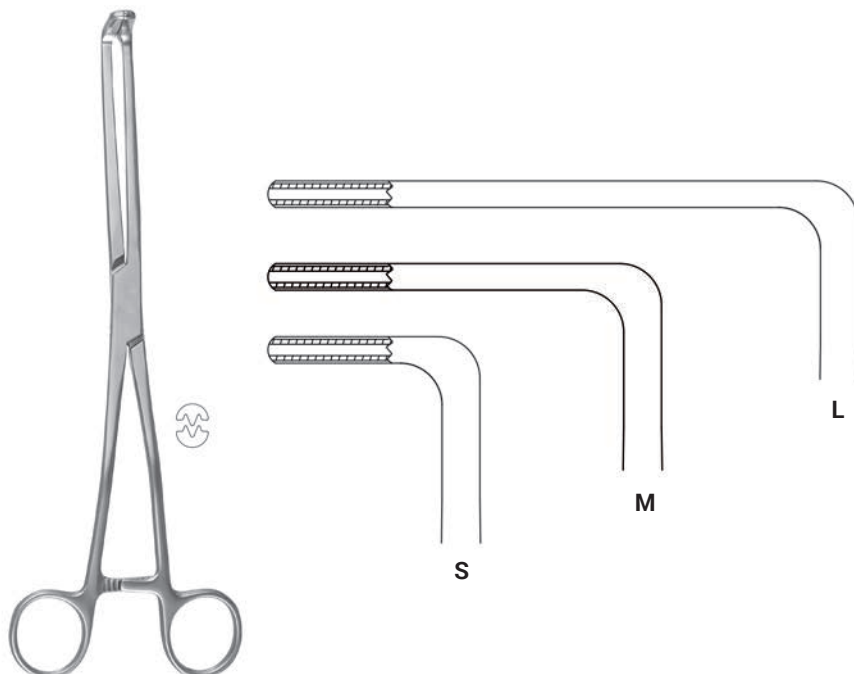

Description	Length	Code
Handles Curved, Jaw 90°, S: Jaw Length 25 mm	22 cm	CC-6046-22
Handles Curved, Jaw 90°, M: Jaw Length 50 mm	22 cm	CC-6047-22
Handles Curved, Jaw 90°, L: Jaw Length 75 mm	22 cm	CC-6048-22

# MICRO VASCULAR CLAMPS

## DeBakey Harken Vascular Clamp

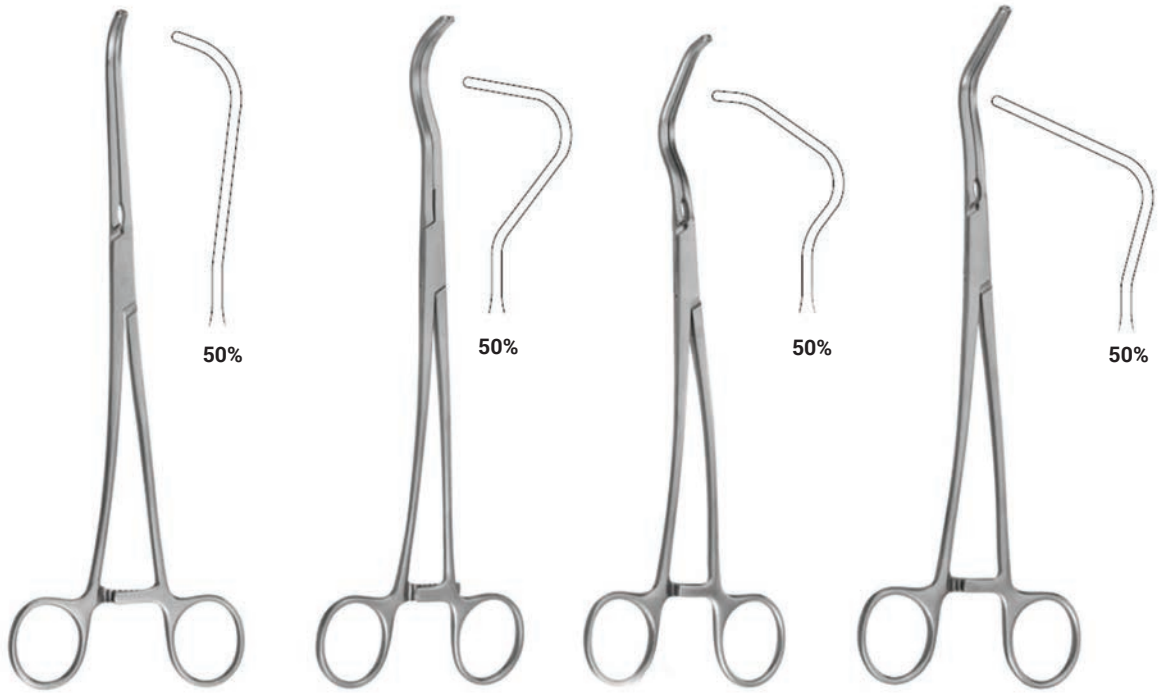

**Description**

- DeBakey Harken Vascular Clamp Handles Curved
- DeBakey Harken Vascular Clamp Handles Curved
- DeBakey Harken Vascular Clamp Handles Curved

**Length**

- 23 cm
- 24 cm
- 26 cm

**Code**

- CC-3033-23
- CC-3032-24
- CC-3031-26

## DeBakey Gastro Intestinal Clamp

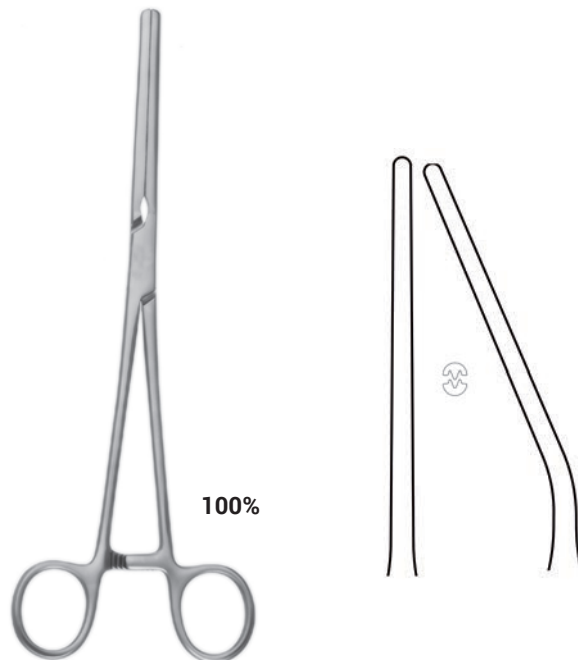

**Description**

- DeBakey Gastro Intestinal Clamp, Handles Straight, Jaw Straight
- DeBakey Gastro Intestinal Clamp, Handles Straight, Jaw 25°

**Length**

- 23 cm
- 23 cm

**Code**

- CC-6043-23
- CC-6044-23

### DeBakey C-form Vascular Clamp

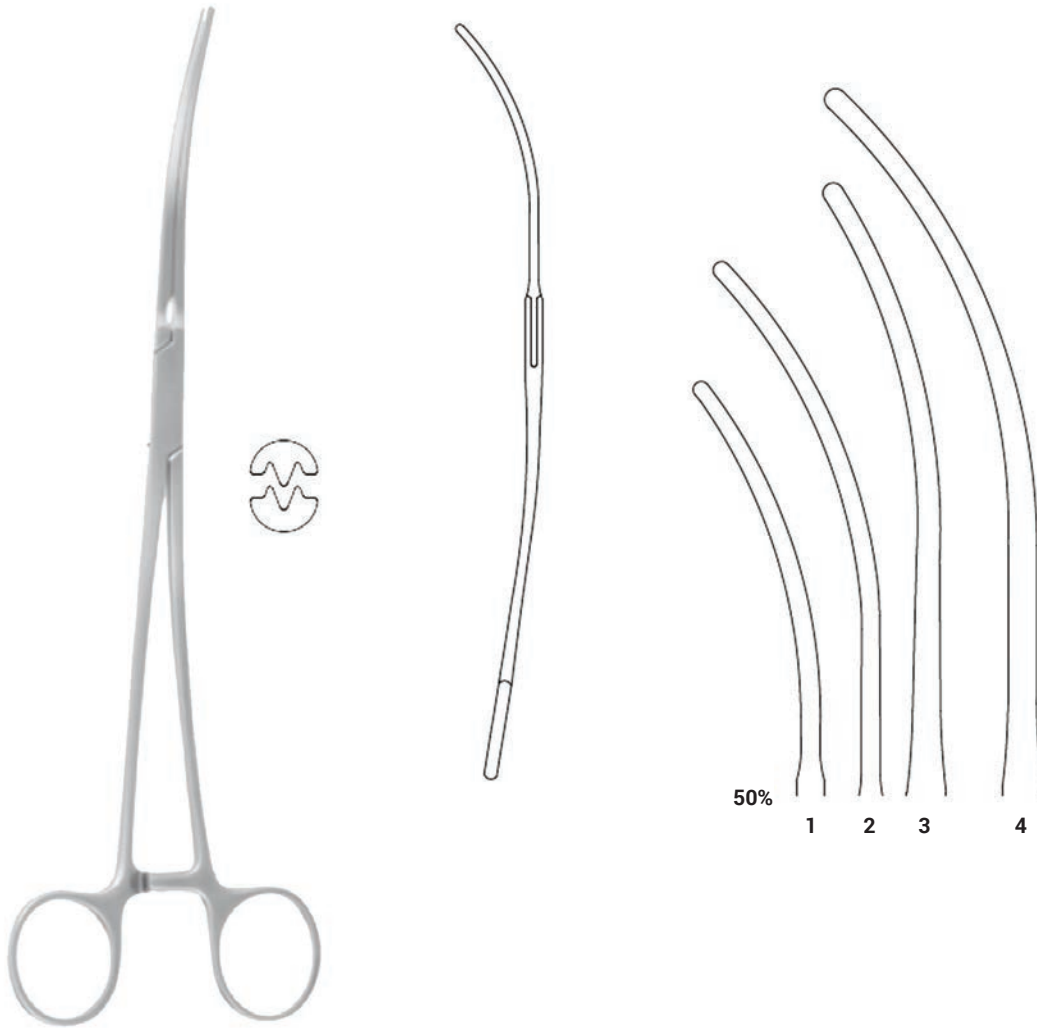

**Description**

- eBakey C-form Vascular Clamp Handles Curved Jaw Curved
- DeBakey C-form Vascular Clamp Handles Curved Jaw Curved
- DDeBakey C-form Vascular Clamp Handles Curved Jaw Curved
- DeBakey C-form Vascular Clamp Handles Curved Jaw Curved

**Length**

**Code**

- 24 cm CC-2602-24
- 25 cm CC-2600-25
- 30 cm CC-2636-30
- 32 cm CC-2637-32



# MICRO VASCULAR CLAMPS

## DeBakey Bahnson Vascular Clamp

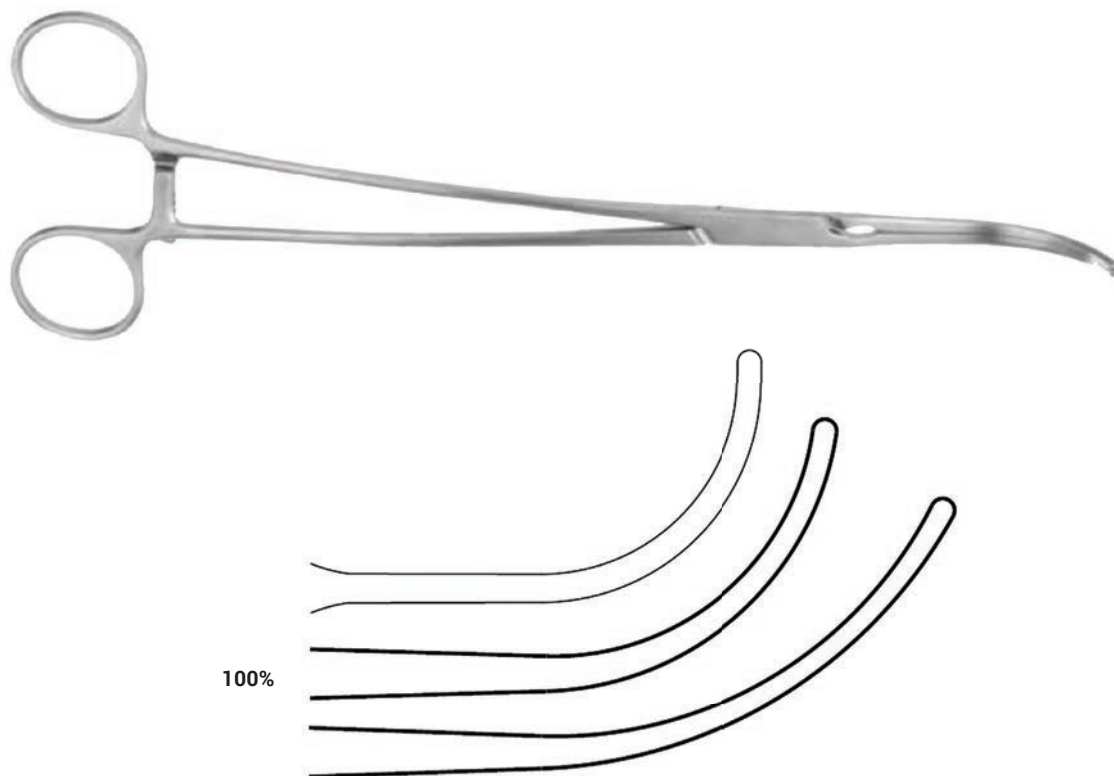
**Description**

DeBakey Bahnson Vascular Clamp Handles Curved Jaw Curved  
 DeBakey Bahnson Vascular Clamp Handles Curved Jaw Curved  
 DeBakey Bahnson Vascular Clamp Handles Curved Jaw Curved

**Length**

24 cm  
 26 cm  
 28 cm

**Code**

CC-2631-24  
 CC-2630-26  
 CC-2632-28



**DeBakey Weber  
Anastomosis  
Vascular Clamp**

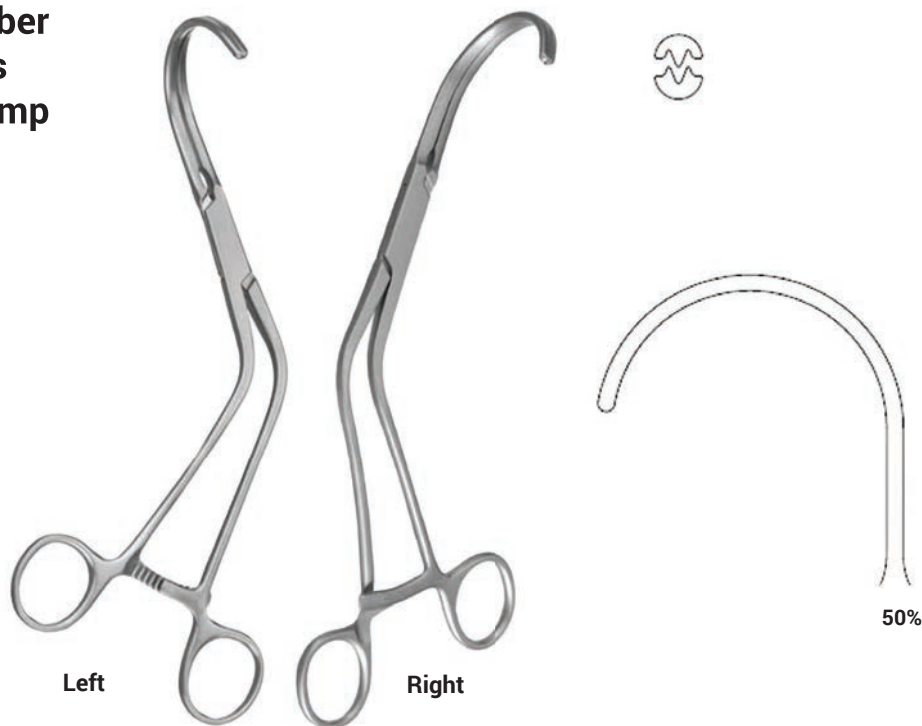

**Description**

DeBakey Weber Anastomosis Vascular Clamp Handles Angled Jaw Right  
DeBakey Weber Anastomosis Vascular Clamp Handles Angled Jaw Left

**Length**

24 cm  
24 cm

**Code**

CC-2855-24  
CC-2856-24

**DeBakey Semb  
Vascular Clamp**



**Description**

DeBakey Semb Vascular Clamp Handles Curved Jaw Fully Curved

**Length**

25 cm

**Code**

CC-2635-25

## DeBakey Vena Cava Vascular Clamp

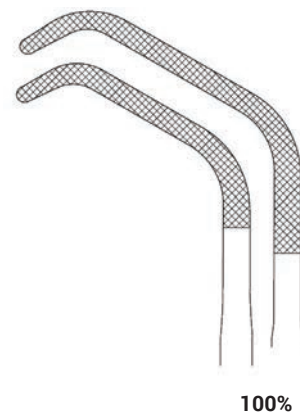
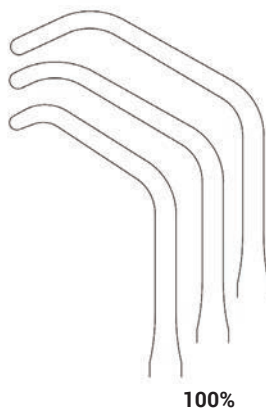
**Description**

DeBakey Vena Cava Vascular Clamp Handles Curved Jaw 60° Small

**Length**

25 cm

**Code**

CC-3004-25

DeBakey Vena Cava Vascular Clamp Handles Curved Jaw 60° Medium

26 cm

CC-3002-26

DeBakey Vena Cava Vascular Clamp Handles Curved Jaw 60° Large

26 cm

CC-3000-26

Criss-Cross Vena Cava Vascular Clamp Handles Curved Jaw 60° Small

27 cm

CC-3018-27

Criss-Cross Vena Cava Vascular Clamp Handles Curved Jaw 60° Large

29 cm

CC-3019-29



**DeBakey Semb Vascular Clamp**



**Description**

DeBakey Semb Vascular Clamp Handles Curved Jaw Fully Curved

**Length**

27 cm

**Code**

CC-2640-27

**DeBakey S-form Vascular Clamp**

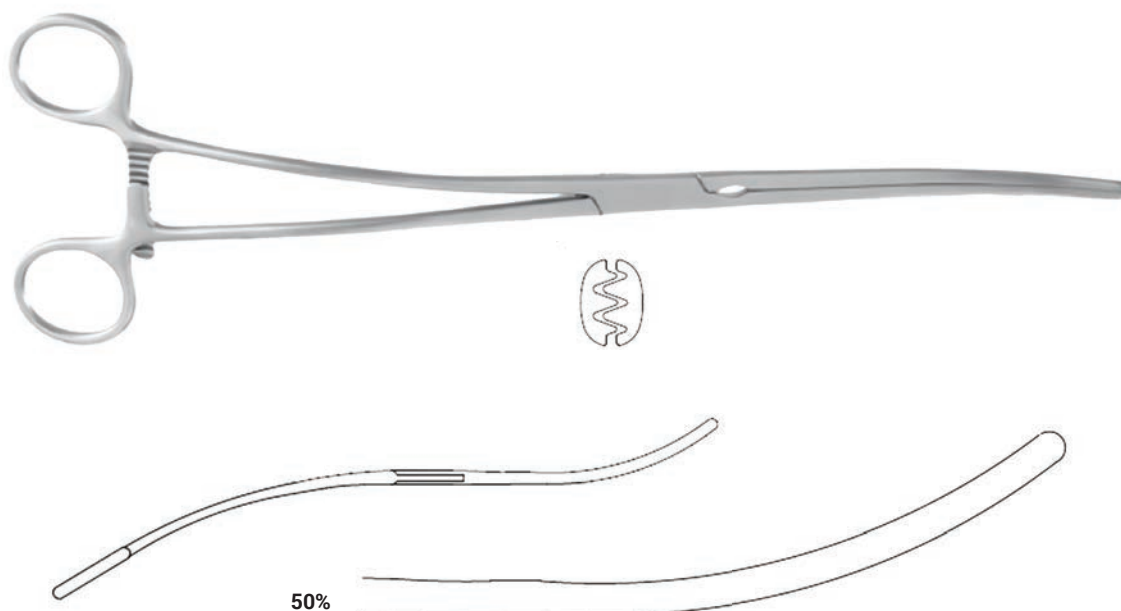

**Description**

DeBakey S-form Vascular Clamp Handles Curved Jaw Curved 115 mm

**Length**

30 cm

**Code**

CC-2600-30

# MICRO VASCULAR CLAMPS

## DeBakey S-form Vascular Clamp

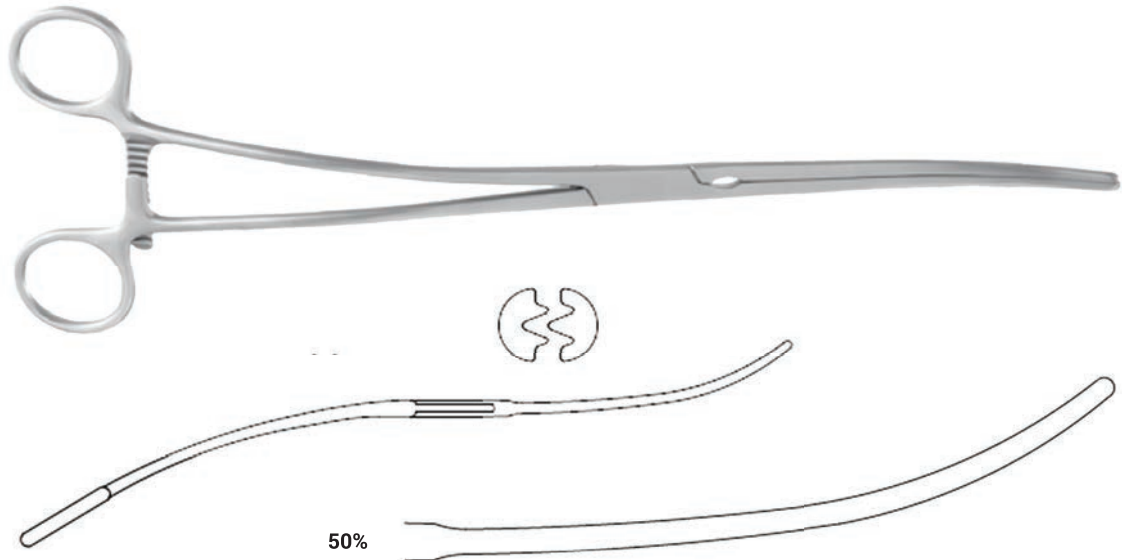

**Description**

DeBakey S-form Vascular Clamp Handles Curved Jaw Curved 115 mm  
 DeBakey S-form Vascular Clamp Handles Curved Jaw Curved 115 mm

**Length**

30 cm  
 33 cm

**Code**

CC-2609-30  
 CC-2610-33

## DeBakey C-form Vascular Clamp

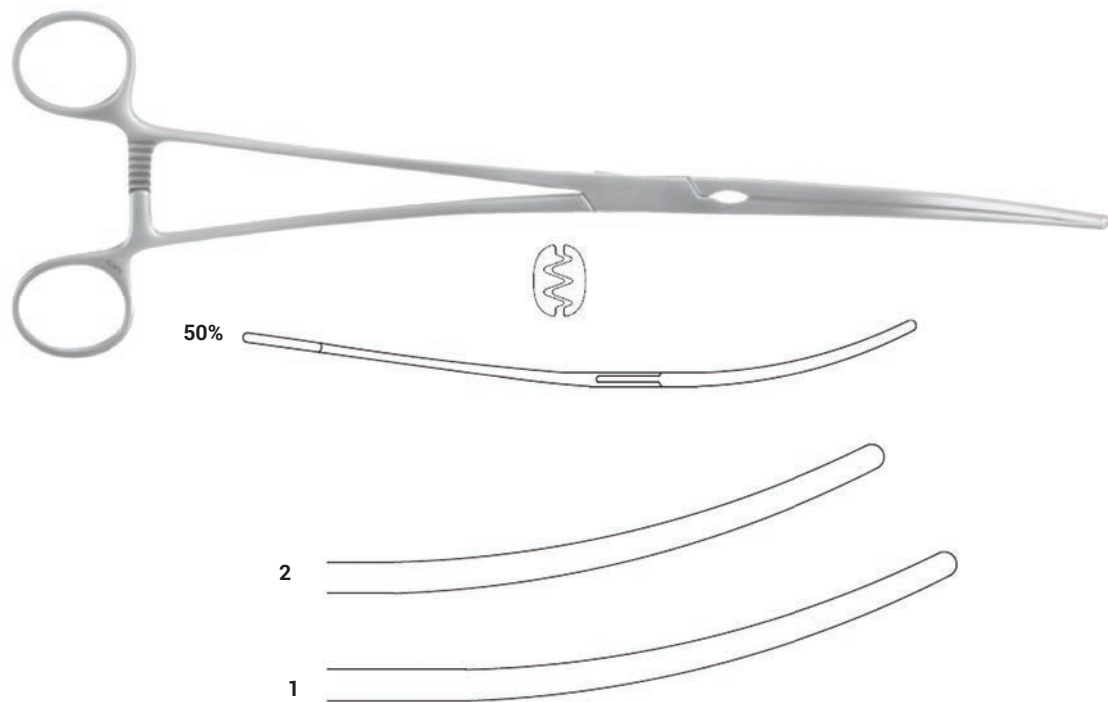

**Description**

DeBakey C-form Vascular Clamp Handles Curved Jaw Curved  
 DeBakey C-form Vascular Clamp Handles Curved Jaw Curved

**Length**

32 cm  
 33 cm

**Code**

CC-2605-32  
 CC-2607-33

**Favaloro Vascular Clamp**

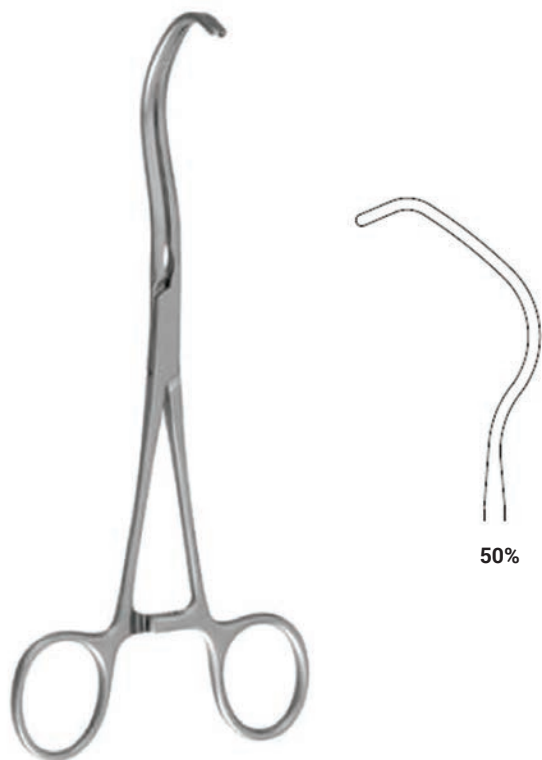

**Description**

Favaloro Vascular Clamp Handles Straight Jaw Satinsky 45 mm

**Length**

19 cm

**Code**

CC-2588-19

**Lambert-Kay Vascular Clamp**

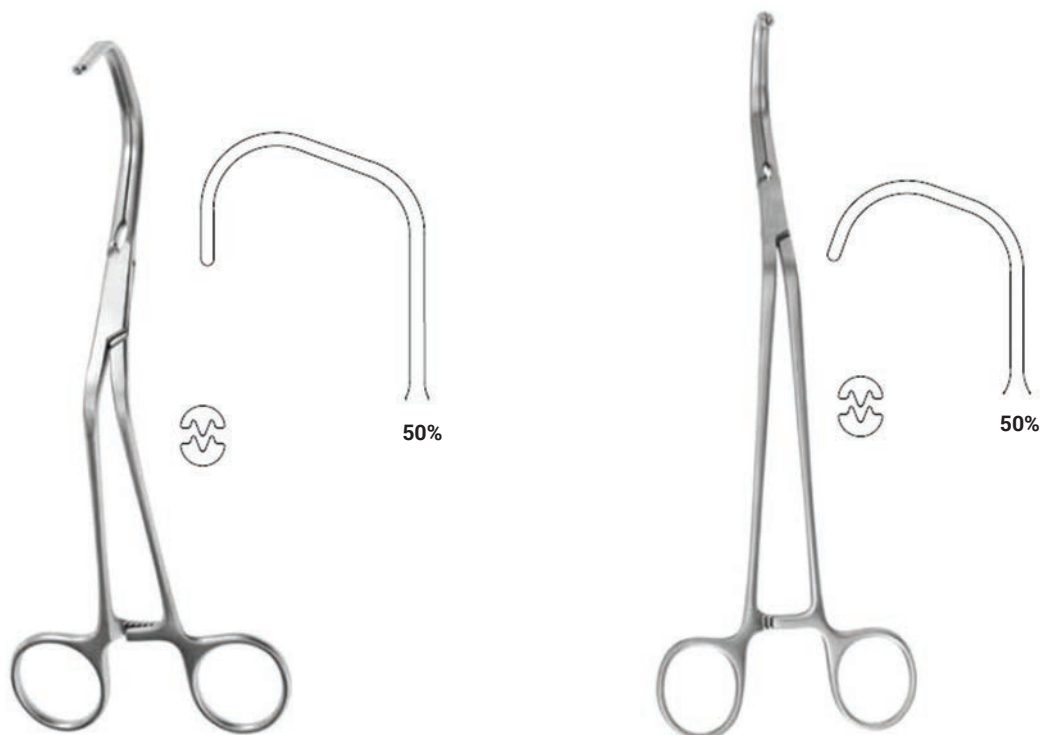

**Description**

- Lambert-Kay Vascular Clamp Handles Angled Jaw 35 mm
- Lambert-Kay Vascular Clamp Handles Angled Jaw 25 mm
- Lambert-Kay Vascular Clamp Handles Angled Jaw 25 mm

**Length**

- 16 cm
- 16 cm
- 20 cm

**Code**

- CC-2580-16
- CC-2585-16
- CC-2584-20

## MICRO VASCULAR CLAMPS

Parsonnet Vascular  
Clamp

50%

**Description**

Parsonnet Vascular Clamp Handles Curved Jaw 24 mm  
 Parsonnet Vascular Clamp Handles Curved Jaw 28 mm  
 Parsonnet Vascular Clamp Handles Curved Jaw 32 mm  
 Parsonnet Vascular Clamp Handles Curved Jaw 38 mm  
 Parsonnet Vascular Clamp Handles Curved Jaw 45 mm

**Length**

23 cm  
 24 cm  
 24 cm  
 24 cm  
 25 cm

**Code**

CC-2589-23  
 CC-2590-24  
 CC-2591-24  
 CC-2592-24  
 CC-2593-25



**Strong Aorta Vascular Clamp**

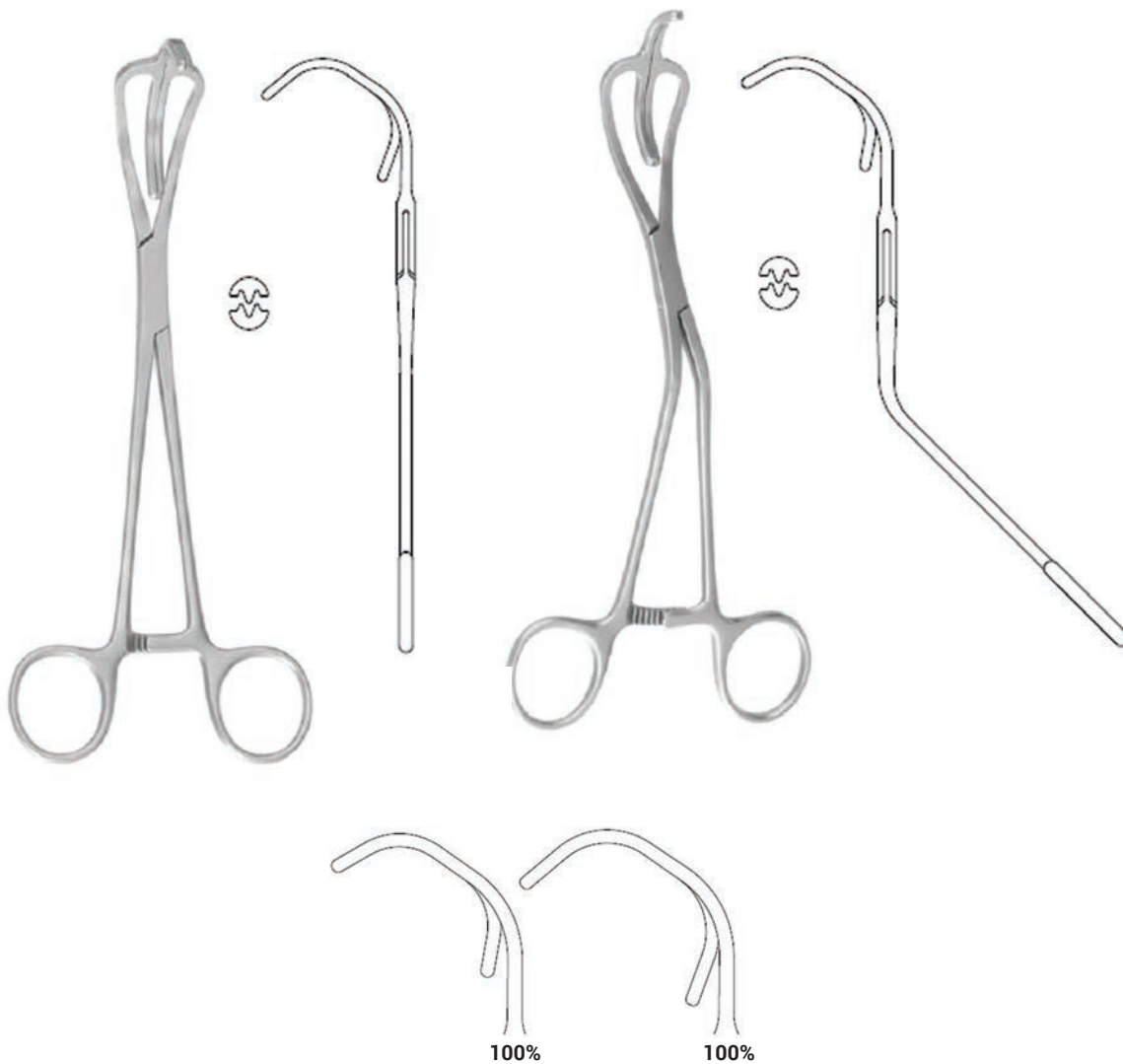

**Description**

Strong Aorta Vascular Clamp Handles Angled Jaw 41 mm  
 Strong Aorta Vascular Clamp Handles Angled Jaw 45 mm  
 Strong Aorta Vascular Clamp Handles Straight Jaw 41 mm  
 Strong Aorta Vascular Clamp Handles Straight Jaw 45 mm

**Length**

18 cm  
 18 cm  
 20 cm  
 20 cm

**Code**

CC-2483-18  
 CC-2484-18  
 CC-2481-20  
 CC-2482-20



Fogerty Insert Clamp

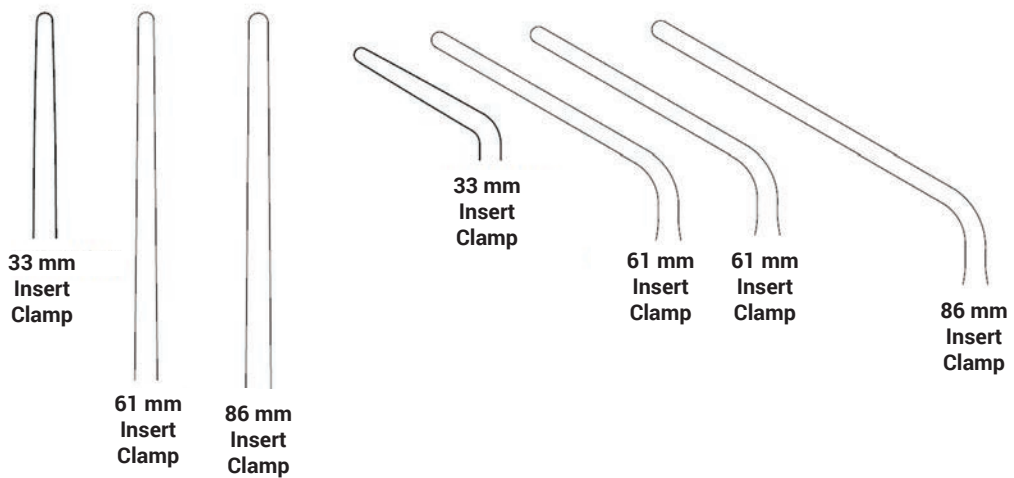

Description	Length	Code
Fogerty Insert Clamp Handles Curved Jaw 60° 33 mm Insert	14 cm	CC-90025-14
Fogerty Insert Clamp Handles Curved Jaw Straight 33 mm Insert	17 cm	CC-90020-17
Fogerty Insert Clamp Handles Curved Jaw 60° 61 mm Insert	25 cm	CC-90040-25
Fogerty Insert Clamp Handles Curved Jaw 60° 61 mm Insert	25 cm	CC-90045-25
Fogerty Insert Clamp Handles Curved Jaw 60° 86 mm Insert	25 cm	CC-90050-25
Fogerty Insert Clamp Handles Curved Jaw Straight 61 mm Insert	30 cm	CC-90030-30
Fogerty Insert Clamp Handles Curved Jaw Straight 86 mm Insert	30 cm	CC-90055-30

### Leland-Jones Vascular Clamp

Description	Length	Code
Leland-Jones Vascular Clamp Handles Straight Jaw Straight 45°	18 cm	CC-2489-18
Leland-Jones Vascular Clamp Handles Straight Jaw Straight 30°	19 cm	CC-2492-19
Leland-Jones Vascular Clamp Handles Straight Jaw Straight	20 cm	CC-2490-20
Leland-Jones Vascular Clamp Handles Straight Jaw Straight 15°	20 cm	CC-2491-20

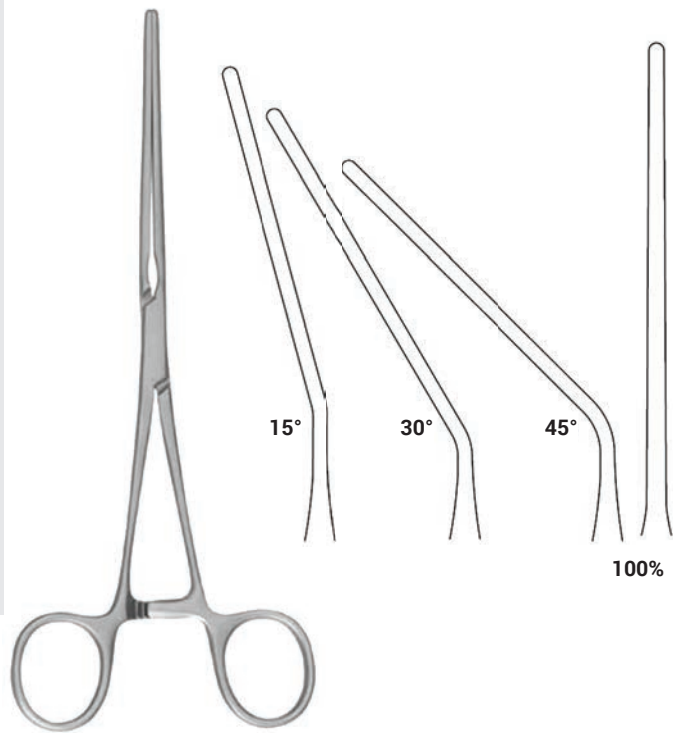

### Wylie Clamp

Description	Length	Code
Wylie Clamp Handles Curved Jaw Strongly Curved	22 cm	CC-2654-22



## Wylie J-type Clamp

Description	Length	Code
Wylie J-type Clamp Handles Curved Jaw Curved	23 cm	CC-2656-23



## Wylie Aorta Clamp

Description	Length	Code
Wylie Aorta Clamp Handles Angled Jaw Slightly Curved	21 cm	CC-2657-21
Wylie Aorta Clamp Handles Angled Jaw Slightly Curved	24 cm	CC-2658-24



## Wylie Aorta Clamp

Description	Length	Code
Wylie Aorta Clamp Handles Angled Jaw Slightly Curved	23 cm	CC-3280-23

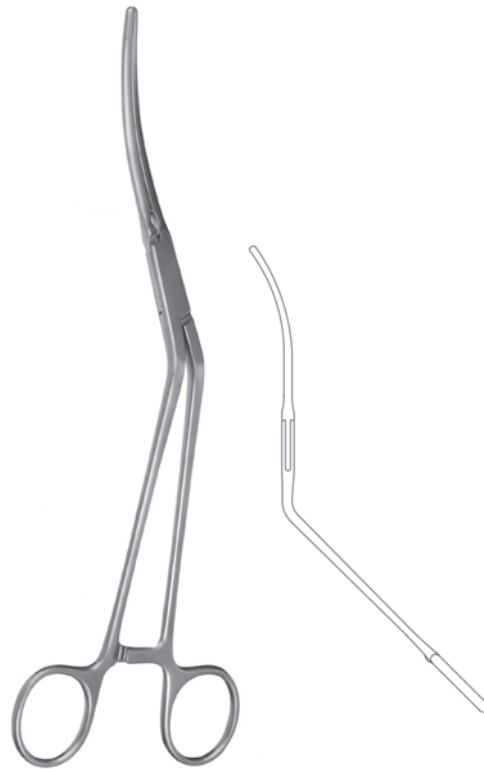

## Wylie External Clamp

Description	Length	Code
Wylie External Clamp Handles Straight Jaw Double Angled	23 cm	CC-2570-23

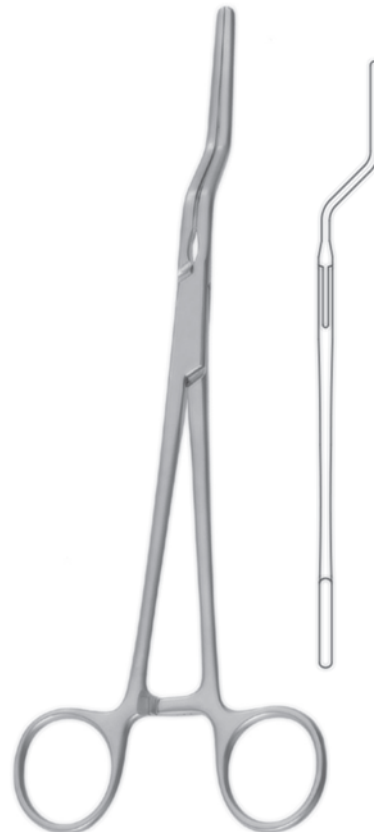

## Wylie Internal Clamp

Description	Length	Code
Wylie Internal Clamp Handles Angled	25 cm	CC-2571-25



## Wylie Vascular Clamp

Description	Length	Code
Wylie Vascular Clamp Handles Curved, Up, Jaw Curved	16 cm	CC-3277-16
Wylie Vascular Clamp Handles Curved, Up, Jaw Curved	18 cm	CC-3276-18



### Wylie Vascular Clamp

Description	Length	Code
Wylie Vascular Clamp Handles Curved, Down, Jaw Curved	16 cm	CC-3279-16
Wylie Vascular Clamp Handles Curved, Down, Jaw Curved	18 cm	CC-3278-18



### Liver Clamp

Description	Length	Code
1. Liver Clamp, Handles Straight, Potts Teeth	25	CC-7496-25
2. Liver Clamp, Handles Straight, Potts Teeth	26	CC-7497-26
3. Liver Clamp, Handles Straight, Potts Teeth	27	CC-7498-27
4. Liver Clamp, Handles Straight, Potts Teeth	27	CC-7499-27

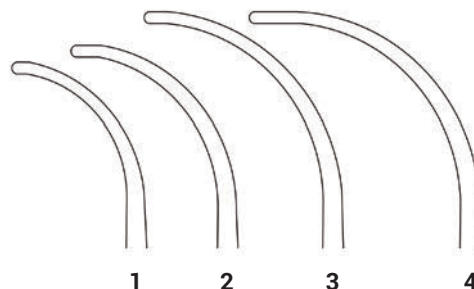

# MICRO VASCULAR CLAMPS

## Peaen Artery Forceps Straight

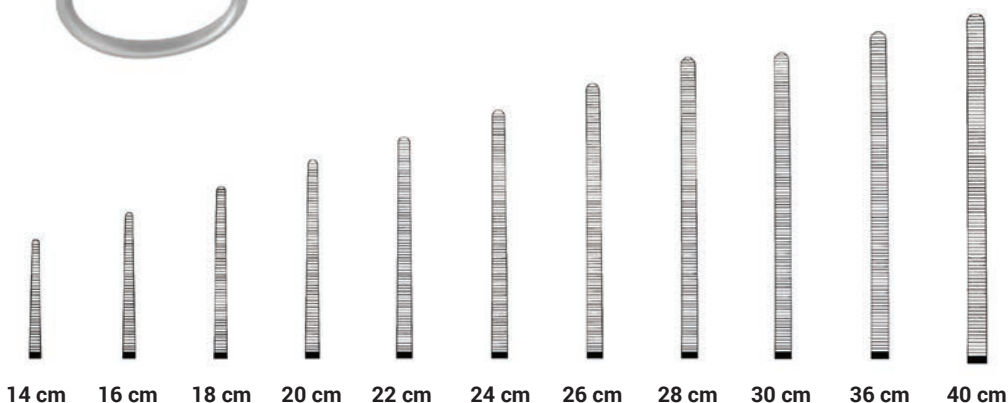

14 cm 16 cm 18 cm 20 cm 22 cm 24 cm 26 cm 28 cm 30 cm 36 cm 40 cm

**Description**

**Length**

**Code**

Peaen Artery Forceps Straight	14 cm	BF-000-14
Peaen Artery Forceps Straight	16 cm	BF-000-16
Peaen Artery Forceps Straight	18 cm	BF-000-18
Peaen Artery Forceps Straight	20 cm	BF-000-20
Peaen Artery Forceps Straight	22 cm	BF-000-22
Peaen Artery Forceps Straight	24 cm	BF-000-24
Peaen Artery Forceps Straight	26 cm	BF-000-26
Peaen Artery Forceps Straight	28 cm	BF-000-28
Peaen Artery Forceps Straight	30 cm	BF-000-30
Peaen Artery Forceps Straight	36 cm	BF-000-36
Peaen Artery Forceps Straight	40 cm	BF-000-40



**Peaen Artery Forceps Curved**

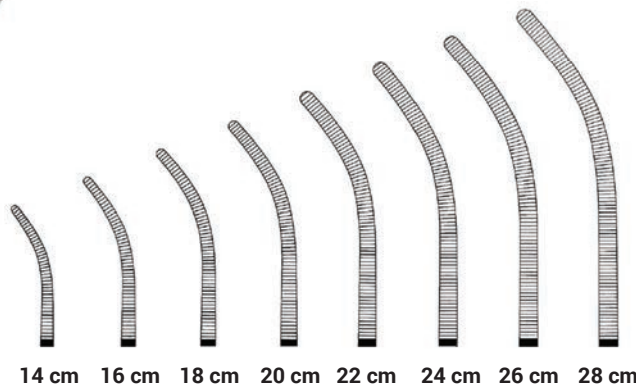

**Description**

Peaen Artery Forceps Curved  
 Peaen Artery Forceps Curved  
 Peaen Artery Forceps Curved  
 Peaen Artery Forceps Curved  
 Peaen Artery Forceps Curved  
 Peaen Artery Forceps Curved  
 Peaen Artery Forceps Curved  
 Peaen Artery Forceps Curved

**Length**

14 cm  
 16 cm  
 18 cm  
 20 cm  
 22 cm  
 24 cm  
 26 cm  
 28 cm

**Code**

BF-001-14  
 BF-001-16  
 BF-001-18  
 BF-001-20  
 BF-001-22  
 BF-001-24  
 BF-001-26  
 BF-001-28



**Spencer-Wells Artery Forceps Straight**

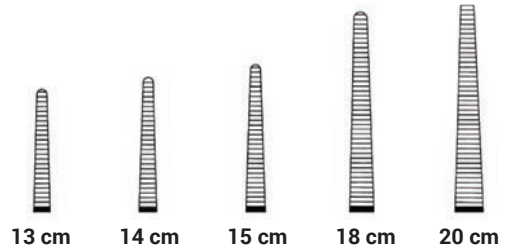

**Description**

Spencer-Wells Artery Forceps Straight  
 Spencer-Wells Artery Forceps Straight  
 Spencer-Wells Artery Forceps Straight  
 Spencer-Wells Artery Forceps Straight  
 Spencer-Wells Artery Forceps Straight

**Length**

13 cm  
 14 cm  
 15 cm  
 18 cm  
 20 cm

**Code**

BF-002-13  
 BF-002-14  
 BF-002-15  
 BF-002-18  
 BF-002-20

**Spencer-Wells Artery Forceps Curved**

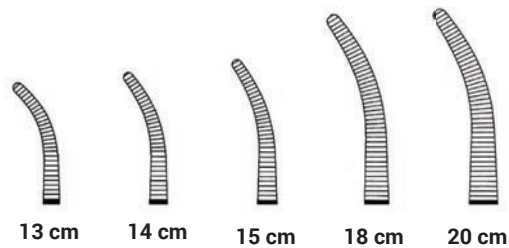

**Description**

Spencer-Wells Artery Forceps Curved  
 Spencer-Wells Artery Forceps Curved  
 Spencer-Wells Artery Forceps Curved  
 Spencer-Wells Artery Forceps Curved  
 Spencer-Wells Artery Forceps Curved

**Length**

13 cm  
 14 cm  
 15 cm  
 18 cm  
 20 cm

**Code**

BF-003-13  
 BF-003-14  
 BF-003-15  
 BF-003-18  
 BF-003-20

**Heiss Artery Forceps**



Description	Length	Code
Heiss Artery Forceps Straight	20 cm	BF-022-20
Heiss Artery Forceps Curved	20 cm	BF-023-20
Heiss Artery Forceps Fully Curved	20 cm	BF-025-20

**Adson Artery Forceps**

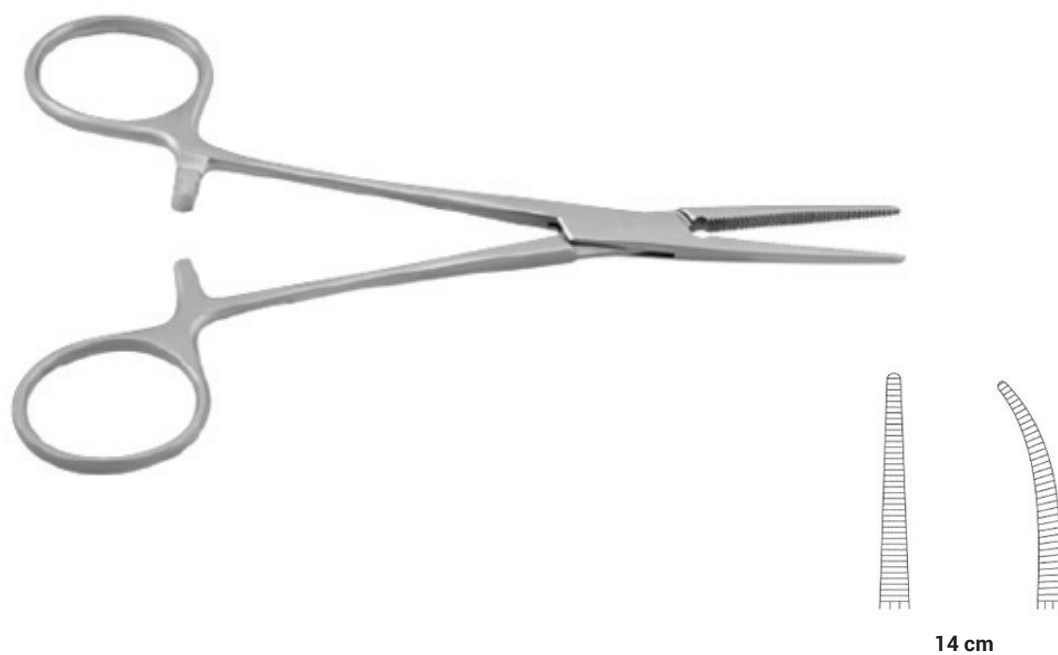

Description	Length	Code
Baby Adson Artery Forceps Curved	14 cm	BF-033-14
Adson Artery Forceps Straight	18 cm	BF-030-18
Adson Artery Forceps Curved	18 cm	BF-031-18

**Crile Artery Forceps**

Description	Length	Code
Crile Artery Forceps Straight	14 cm	BF-048-14
Crile Artery Forceps Curved	14 cm	BF-049-14

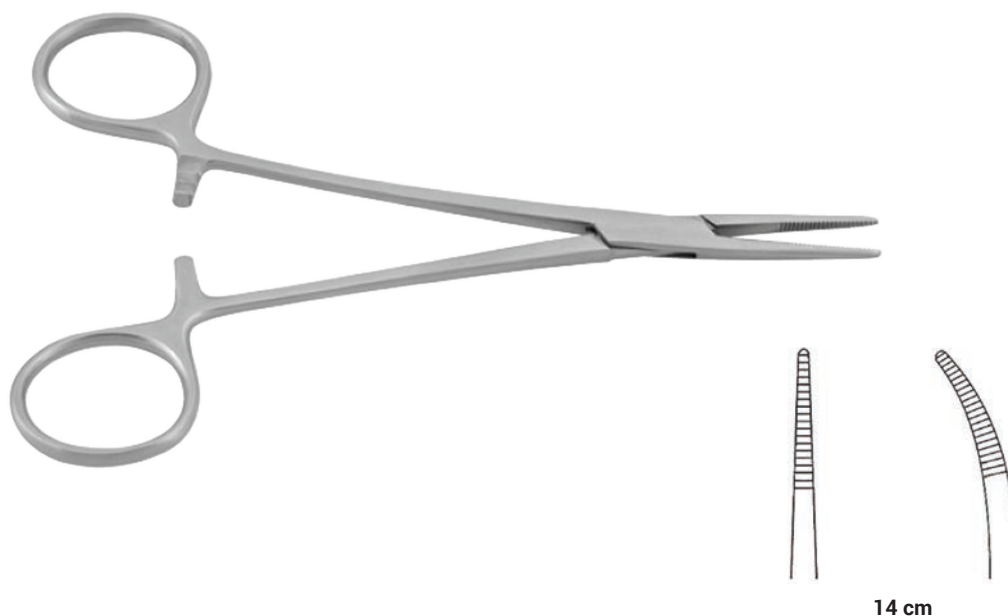
**Kelly Artery Forceps**

Description	Length	Code
Kelly Artery Forceps Straight	14 cm	BF-033-14
Kelly Artery Forceps Curved	14 cm	BF-034-14

### Birkett Artery Forceps



18 cm

**Description**

Birkett Artery Forceps Straight  
 Birkett Artery Forceps Curved

**Length**

18 cm  
 18 cm

**Code**

BF-056-18  
 BF-057-18

### Halsted-Mosquito Artery Forceps

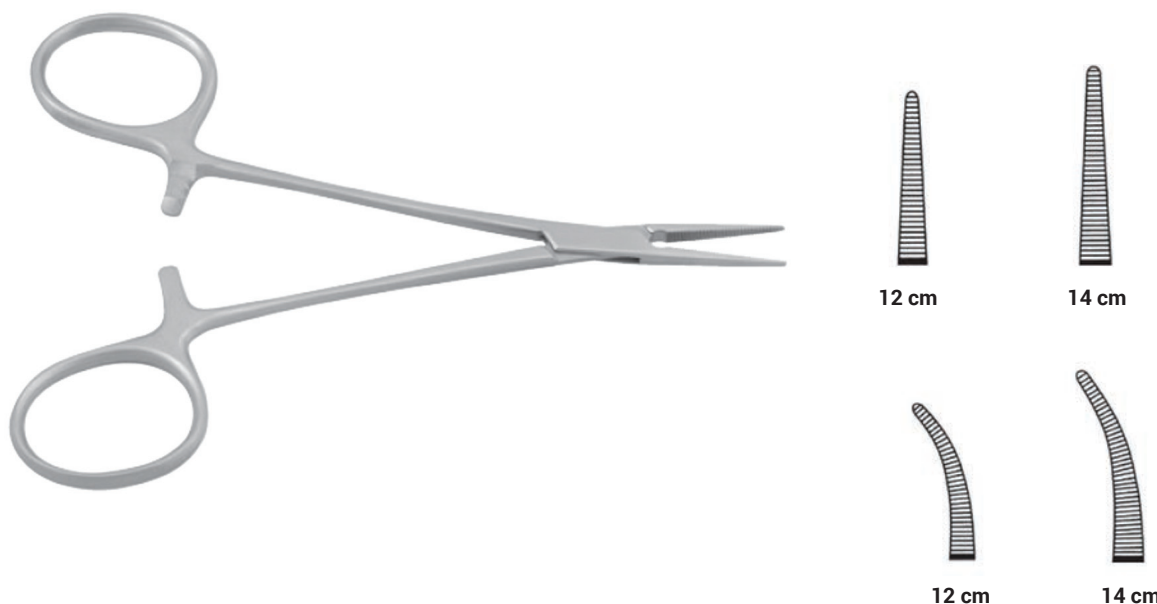

12 cm

14 cm

12 cm

14 cm

**Description**

Halsted-Mosquito Artery Forceps Straight  
 Halsted-Mosquito Artery Forceps Curved  
 Halsted-Mosquito Artery Forceps Straight  
 Halsted-Mosquito Artery Forceps Curved

**Length**

12 cm  
 12 cm  
 14 cm  
 14 cm

**Code**

BF-060-12  
 BF-061-12  
 BF-060-14  
 BF-061-14

# MICRO VASCULAR CLAMPS

## Micro-Mosquito Artery Forceps

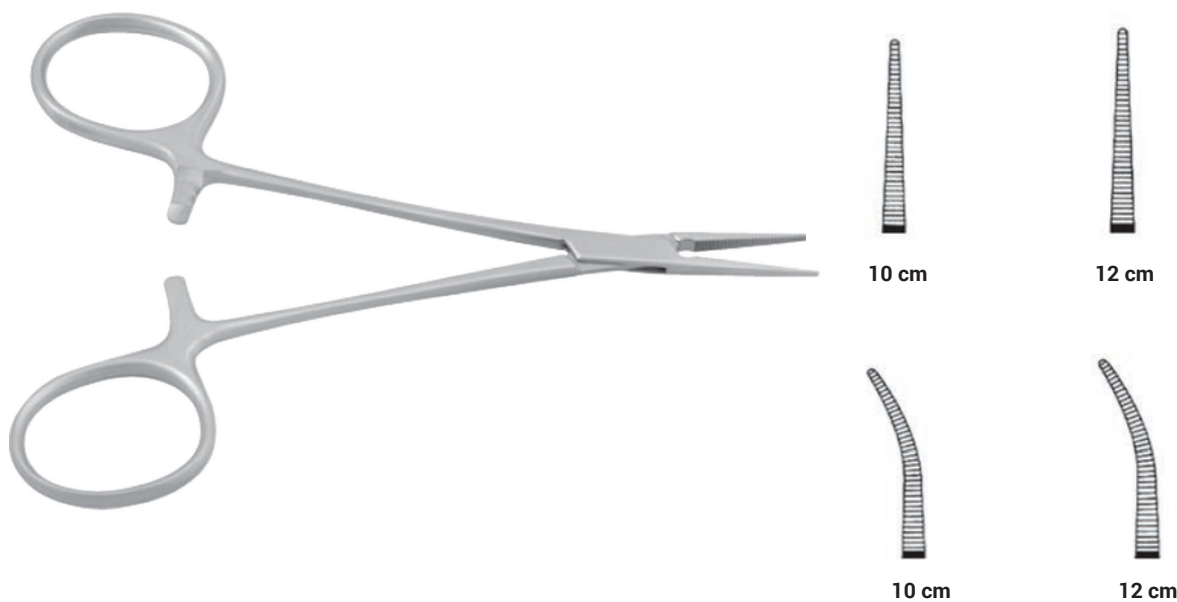

Description	Length	Code
Micro-Mosquito Artery Forceps Straight	10 cm	BF-062-10
Micro-Mosquito Artery Forceps Curved	10 cm	BF-063-10
Micro-Mosquito Artery Forceps Straight	12 cm	BF-062-12
Micro-Mosquito Artery Forceps Curved	12 cm	BF-063-12



### Kocher Artery Forceps Straight

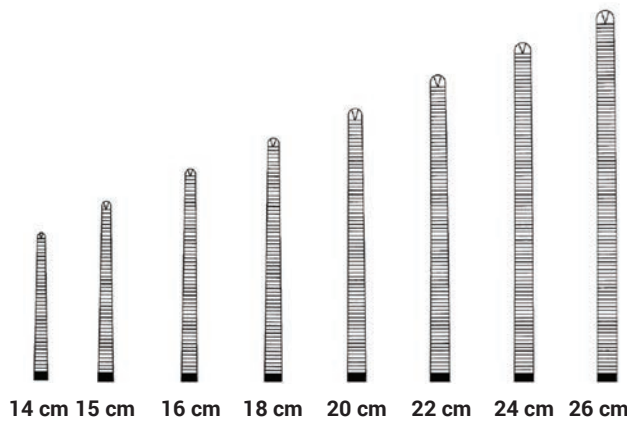

**Description**

Kocher Artery Forceps Straight  
 Kocher Artery Forceps Straight  
 Kocher Artery Forceps Straight  
 Kocher Artery Forceps Straight  
 Kocher Artery Forceps Straight  
 Kocher Artery Forceps Straight  
 Kocher Artery Forceps Straight  
 Kocher Artery Forceps Straight

**Length**

14 cm  
 15 cm  
 16 cm  
 18 cm  
 20 cm  
 22 cm  
 24 cm  
 26 cm

**Code**

BF-100-14  
 BF-100-15  
 BF-100-16  
 BF-100-18  
 BF-100-20  
 BF-100-22  
 BF-100-24  
 BF-100-26

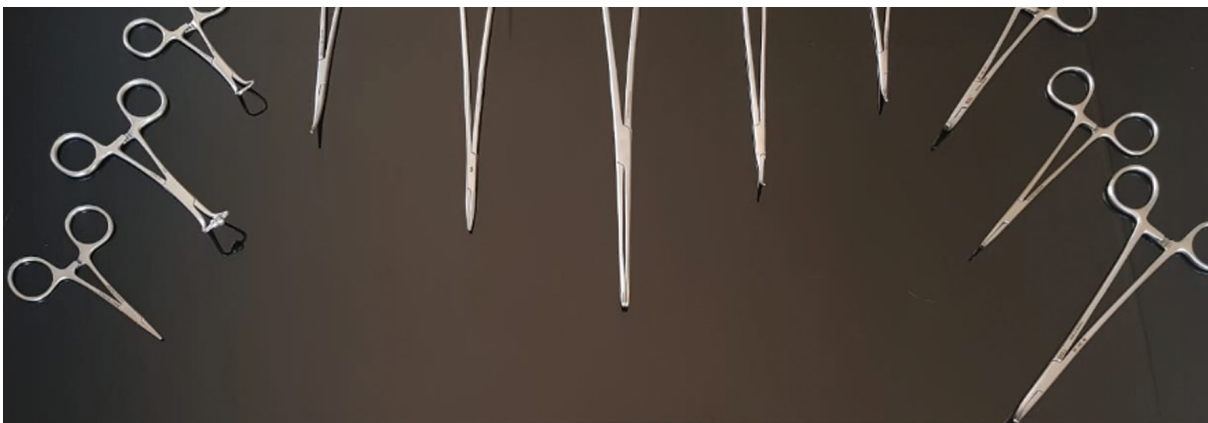

# MICRO VASCULAR CLAMPS

Kocher Artery Forceps Curved

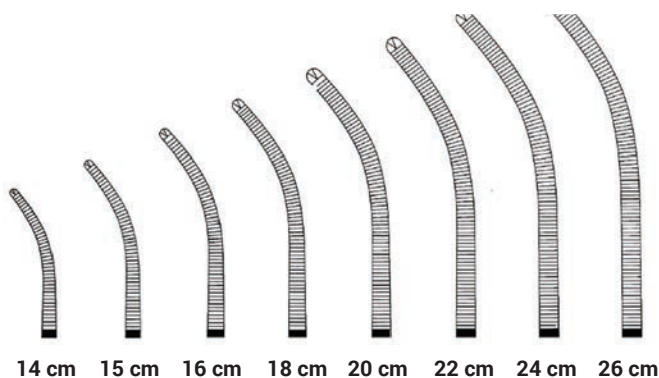

Description	Length	Code
Kocher Artery Forceps Curved	14 cm	BF-101-14
Kocher Artery Forceps Curved	15 cm	BF-101-15
Kocher Artery Forceps Curved	16 cm	BF-101-16
Kocher Artery Forceps Curved	18 cm	BF-101-18
Kocher Artery Forceps Curved	20 cm	BF-101-20
Kocher Artery Forceps Curved	22 cm	BF-101-22
Kocher Artery Forceps Curved	24 cm	BF-101-24
Kocher Artery Forceps Curved	26 cm	BF-101-26



**Gemini Artery Forceps Curved**

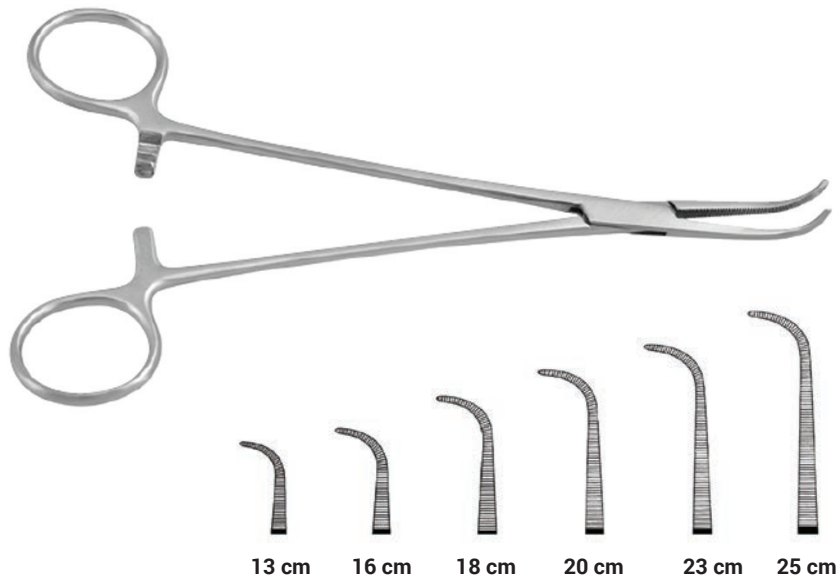

**Description**

Gemini Artery Forceps Curved  
 Gemini Artery Forceps Curved  
 Gemini Artery Forceps Curved  
 Gemini Artery Forceps Curved  
 Gemini Artery Forceps Curved  
 Gemini Artery Forceps Curved

**Length**

13 cm  
 16 cm  
 18 cm  
 20 cm  
 23 cm  
 25 cm

**Code**

BF-237-13  
 BF-237-16  
 BF-237-18  
 BF-237-20  
 BF-237-23  
 BF-237-25

**Crafoord Artery Forceps Curved**

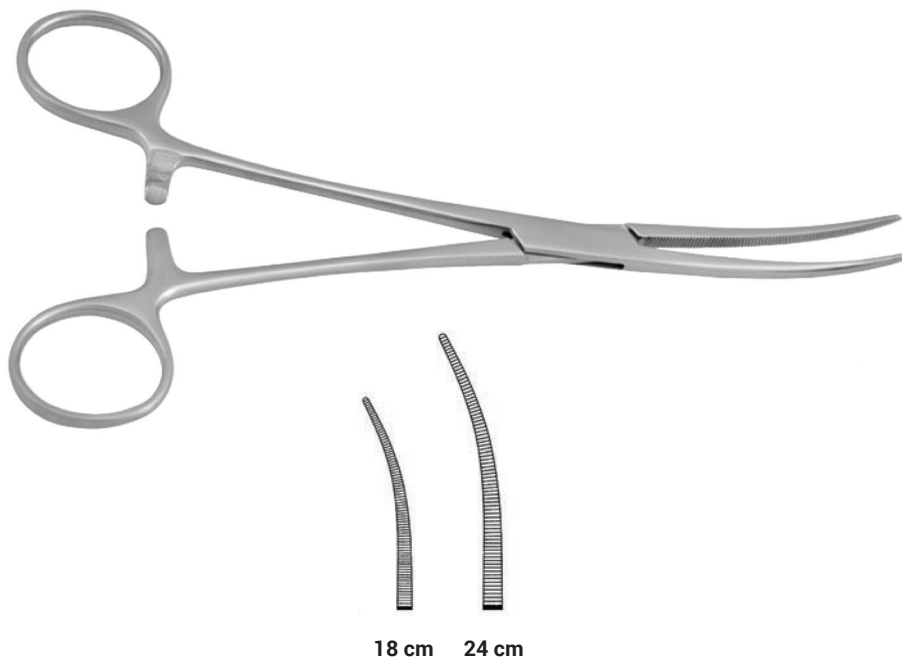

**Description**

Crafoord Artery Forceps Curved  
 Crafoord Artery Forceps Curved

**Length**

18 cm  
 24 cm

**Code**

BF-245-18  
 BF-245-24

### Roberts Artery Forceps

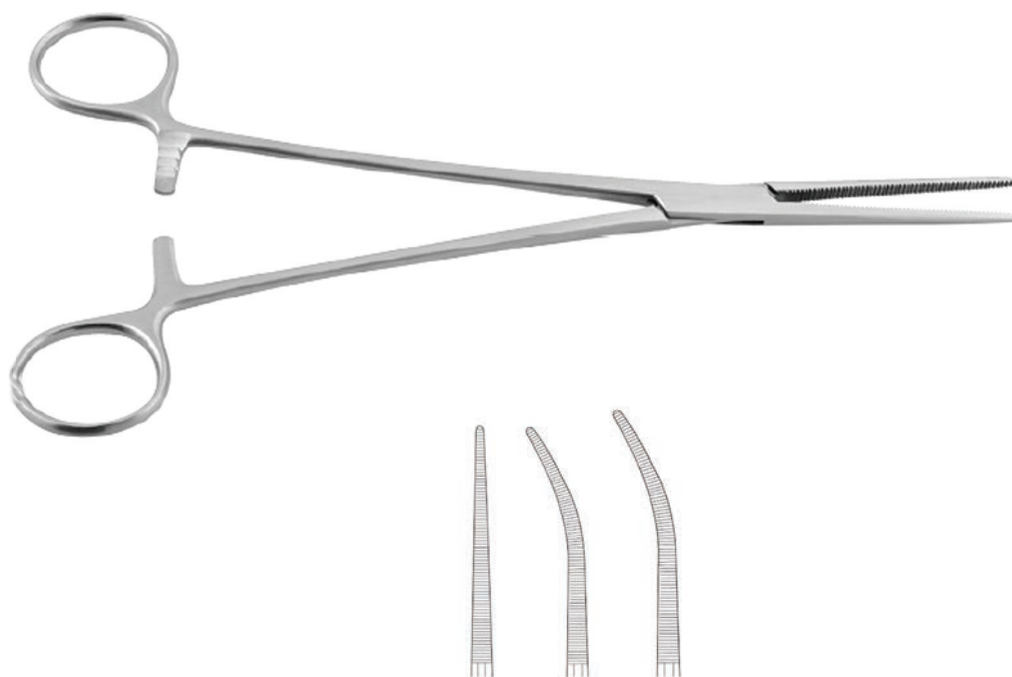

22 cm

#### Description

Roberts Artery Forceps Straight  
 Roberts Artery Forceps Curved  
 Roberts Artery Forceps Curved

#### Length

22 cm  
 22 cm  
 25 cm

#### Code

BF-266-22  
 BF-267-22  
 BF-267-25

### Bailey Fine Forceps



#### Description

Bailey Fine Forceps 30° Angle Jaw  
 Bailey Fine Forceps 60° Angle Jaw  
 Bailey Fine Forceps 90° Angle Jaw

#### Length

18 cm  
 18 cm  
 18 cm

#### Code

BF-411-30  
 BF-411-60  
 BF-411-90

Mixer Artery Forceps Curved

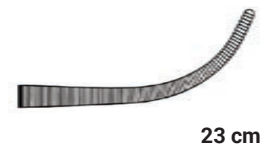
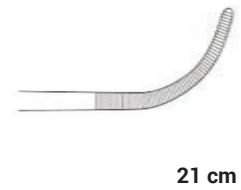
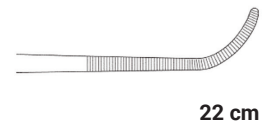

**Description**

Overholt-Mixer Artery Forceps Curved  
 Mixer Artery Forceps Curved  
 Mixer Artery Forceps Curved

**Length**

21 cm  
 22 cm  
 23 cm

**Code**

BF-261-21  
 BF-259-22  
 BF-259-23

Mixer Artery Forceps Curved



Description

Mixer Artery Forceps Curved  
 Mixer Artery Forceps Curved  
 Mixer Artery Forceps Curved  
 Mixer Artery Forceps Curved

Length

14 cm  
 15 cm  
 19 cm  
 23 cm

Code

BF-263-14  
 BF-263-15  
 BF-263-19  
 BF-263-23

Lahey Artery Forceps

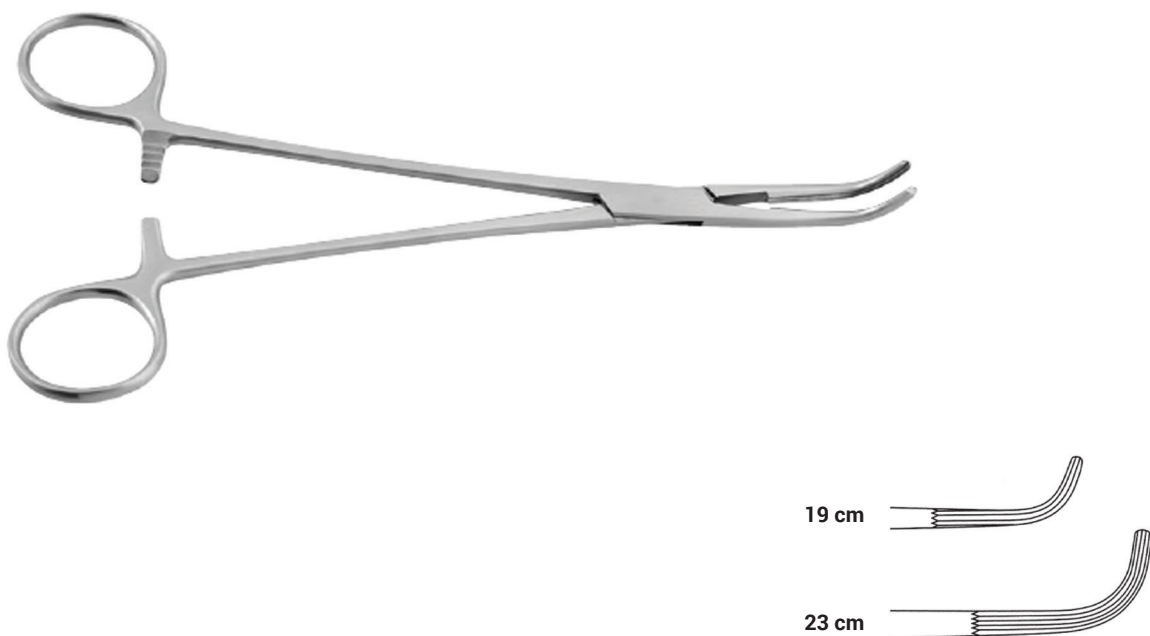

Description

Lahey Artery Forceps Curved  
 Lahey Artery Forceps Curved

Length

19 cm  
 23 cm

Code

BF-361-19  
 BF-361-23

**Rampléy Sponge Holding Forceps**

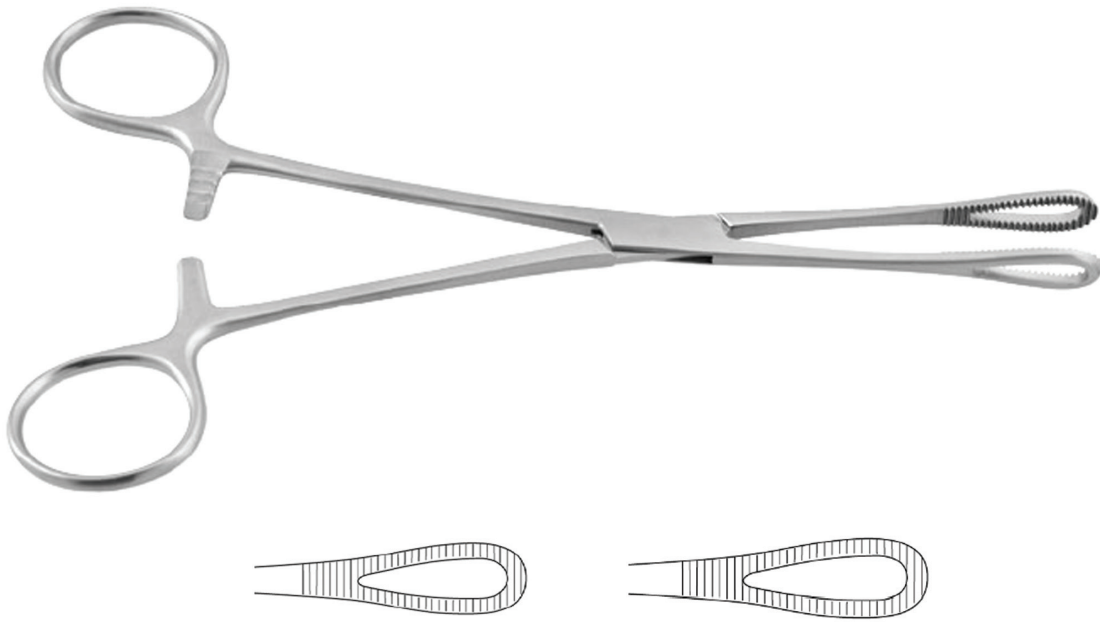

Description	Length	Code
Rampléy Sponge Holding Forceps	18 cm	BF-742-18
Rampléy Sponge Holding Forceps	25 cm	BF-742-25

**Duval Grasping Forceps**

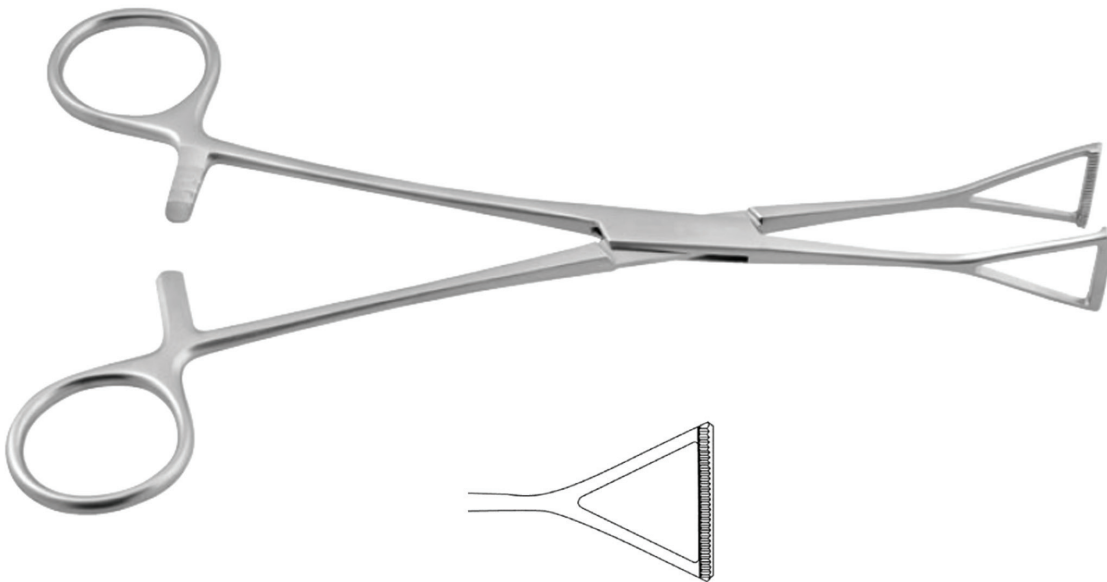

Description	Length	Code
Duval Grasping Forceps	18 cm	BF-752-18
Duval Grasping Forceps	20 cm	BF-752-20
Duval Grasping Forceps	23 cm	BF-752-23

**Duval DeBakey Grasping Forceps**

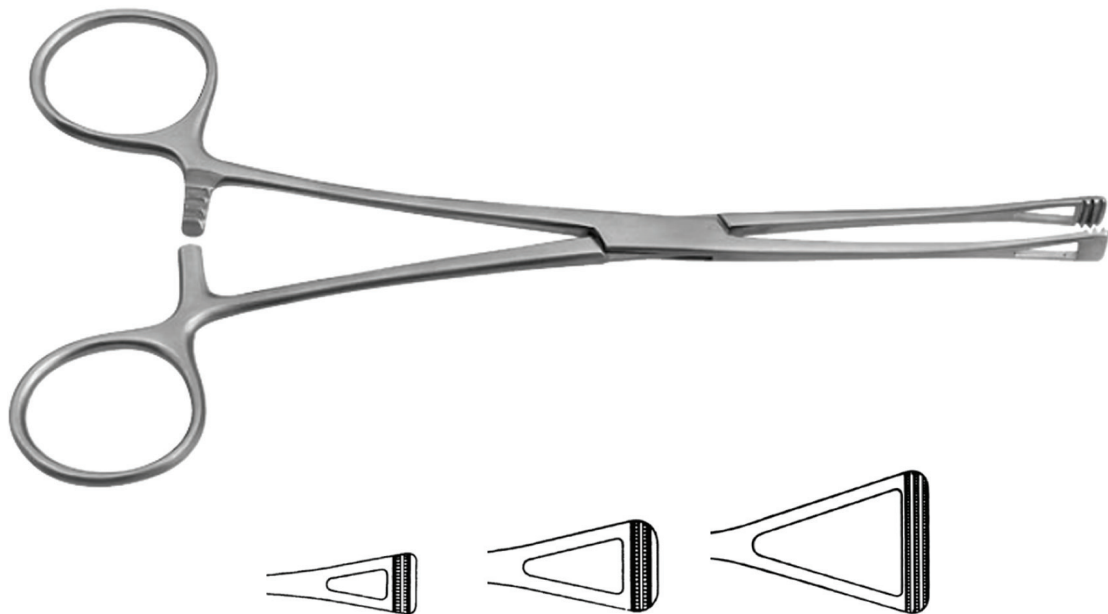

Description	Length	Code
Duval DeBakey Grasping Forceps	18 cm	BF-755-18
Duval DeBakey Grasping Forceps	20 cm	BF-755-20
Duval DeBakey Grasping Forceps	23 cm	BF-755-23

**Babcock Grasping Forceps**

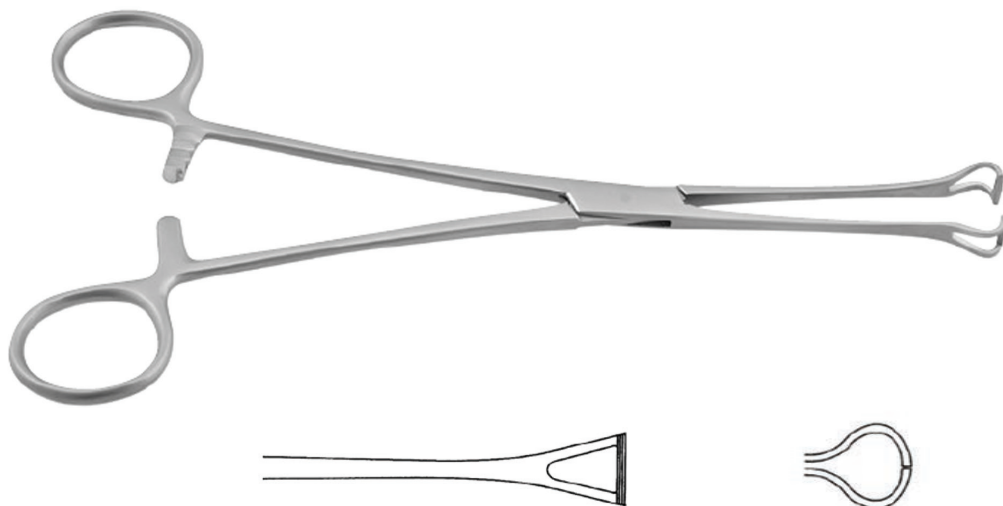

Description	Length	Code
Babcock Grasping Forceps	16 cm	BF-760-16
Babcock Grasping Forceps	18 cm	BF-760-18
Babcock Grasping Forceps	20 cm	BF-760-20
Babcock Grasping Forceps	24 cm	BF-760-24
Babcock Grasping Forceps	36 cm	BF-760-36

**Allis Grasping Forceps**

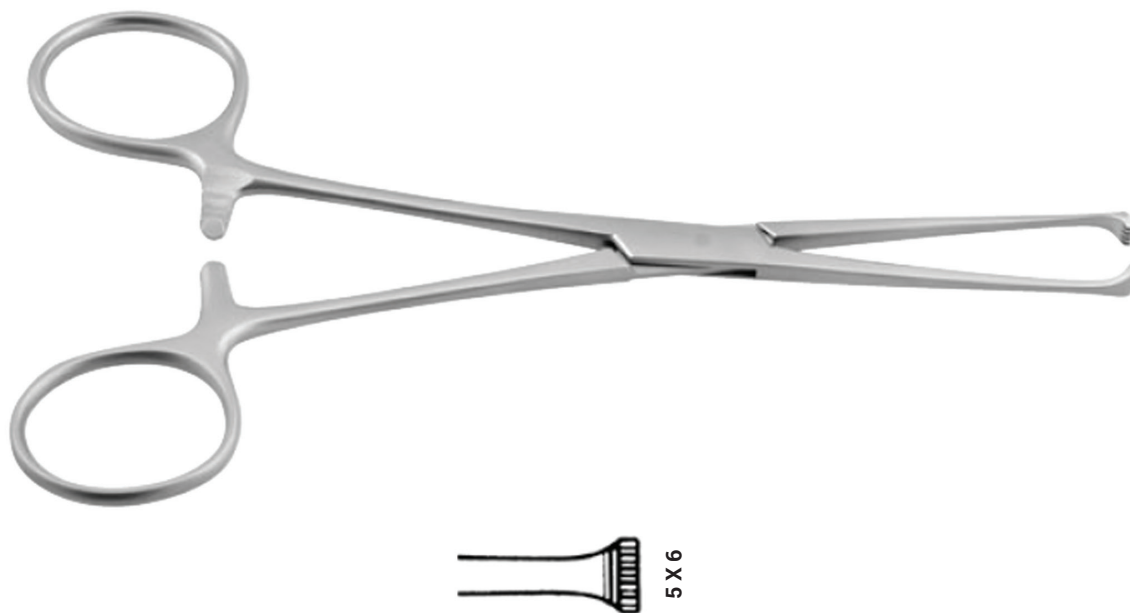

**Description**

Allis Grasping Forceps  
 Allis Grasping Forceps  
 Allis Grasping Forceps  
 Allis Grasping Forceps

**Length**

15 cm  
 19 cm  
 22 cm  
 25 cm

**Code**

BF-766-15  
 BF-766-19  
 BF-766-22  
 BF-766-25

**Littlewood Grasping Forceps**

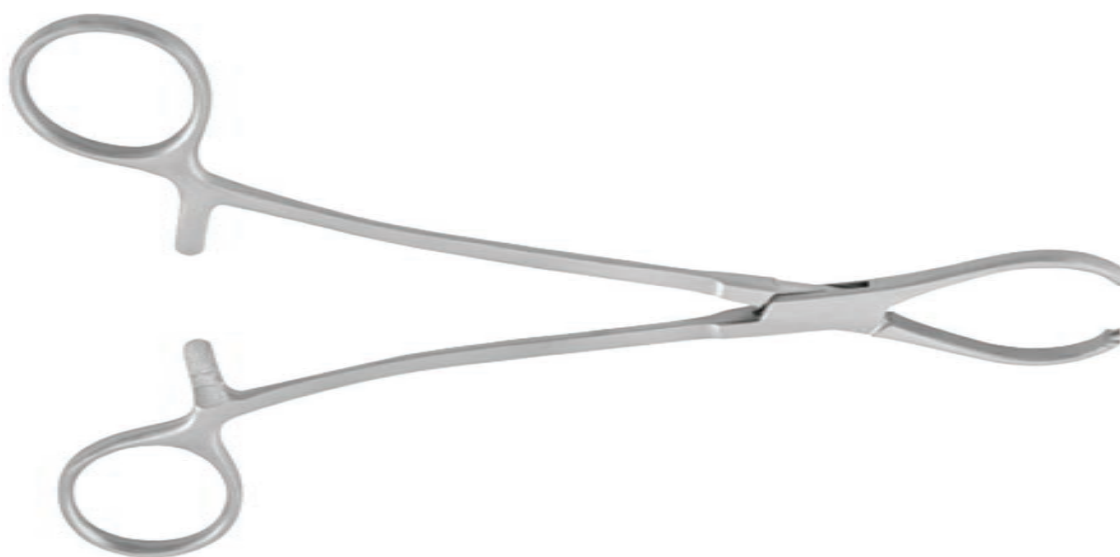

**Description**

Littlewood Grasping Forceps

**Length**

19 cm

**Code**

BF-773-19

**Backhaus Towel Forceps****Description**

Backhaus Towel Forceps  
 Backhaus Towel Forceps  
 Backhaus Towel Forceps  
 Backhaus Towel Forceps

**Length**

8 cm  
 11 cm  
 13 cm  
 16 cm

**Code**

BF-801-08  
 BF-801-11  
 BF-801-13  
 BF-801-16

**Ball & Socket Towel Forceps****Description**

Ball & Socket Towel Forceps  
 Ball & Socket Towel Forceps

**Length**

11 cm  
 14 cm

**Code**

BF-805-11  
 BF-805-14

**Lane Towel Forceps**



Description	Length	Code
Lane Towel Forceps	13 cm	BF-811-13
Lane Towel Forceps	15 cm	BF-811-15
Lane Towel Forceps	20 cm	BF-811-20

**Lorna Towel Forceps**

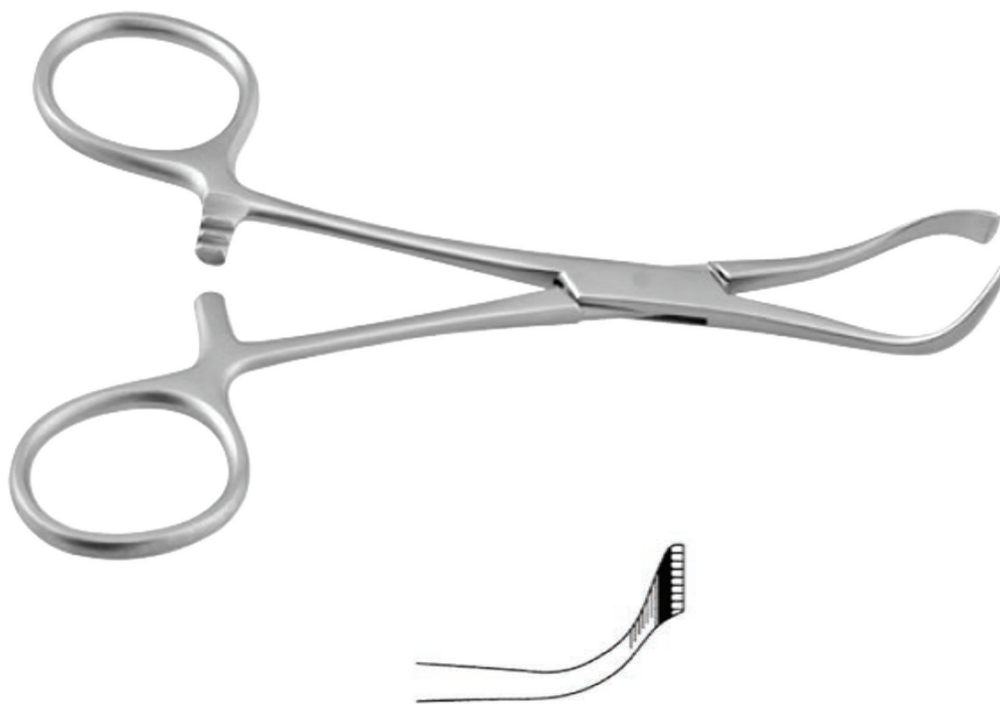

Description	Length	Code
Lorna Towel Forceps	10 cm	BF-806-10
Lorna Towel Forceps	13 cm	BF-806-13

# MICRO VASCULAR CLAMPS

## Tubing Clamp Forceps Straight



**Description**

Tubing Clamp Forceps  
 Tubing Clamp Forceps  
 Tubing Clamp Forceps  
 Tubing Clamp Forceps

**Length**

15 cm  
 18 cm  
 19 cm  
 20 cm

**Code**

BF-844-15  
 BF-844-18  
 BF-844-19  
 BF-844-20

## Tubing Clamp With Guard Forceps Straight



**Description**

Tubing Clamp with Guard Forceps  
 Tubing Clamp with Guard Forceps  
 Tubing Clamp with Guard Forceps

**Length**

15 cm  
 18 cm  
 20 cm

**Code**

BF-846-15  
 BF-848-18  
 BF-848-20

**O'Shaugnessy Artery Forceps**



**Description**

O'Shaugnessy Artery Forceps  
 O'Shaugnessy Artery Forceps  
 O'Shaugnessy Artery Forceps  
 O'Shaugnessy Artery Forceps  
 O'Shaugnessy Artery Forceps

**Length**

15 cm  
 18 cm  
 20 cm  
 23 cm  
 26 cm

**Code**

BF-368-15  
 BF-368-18  
 BF-368-20  
 BF-368-23  
 BF-368-26

**Gregory Suture Tag Forceps**



**Description**

Suture Tag Forceps

**Length**

9 cm

**Code**

BF-410-09



# SKILL<sup>®</sup>

Surgical Instruments

## CARDIOVASCULAR RETRACTORS

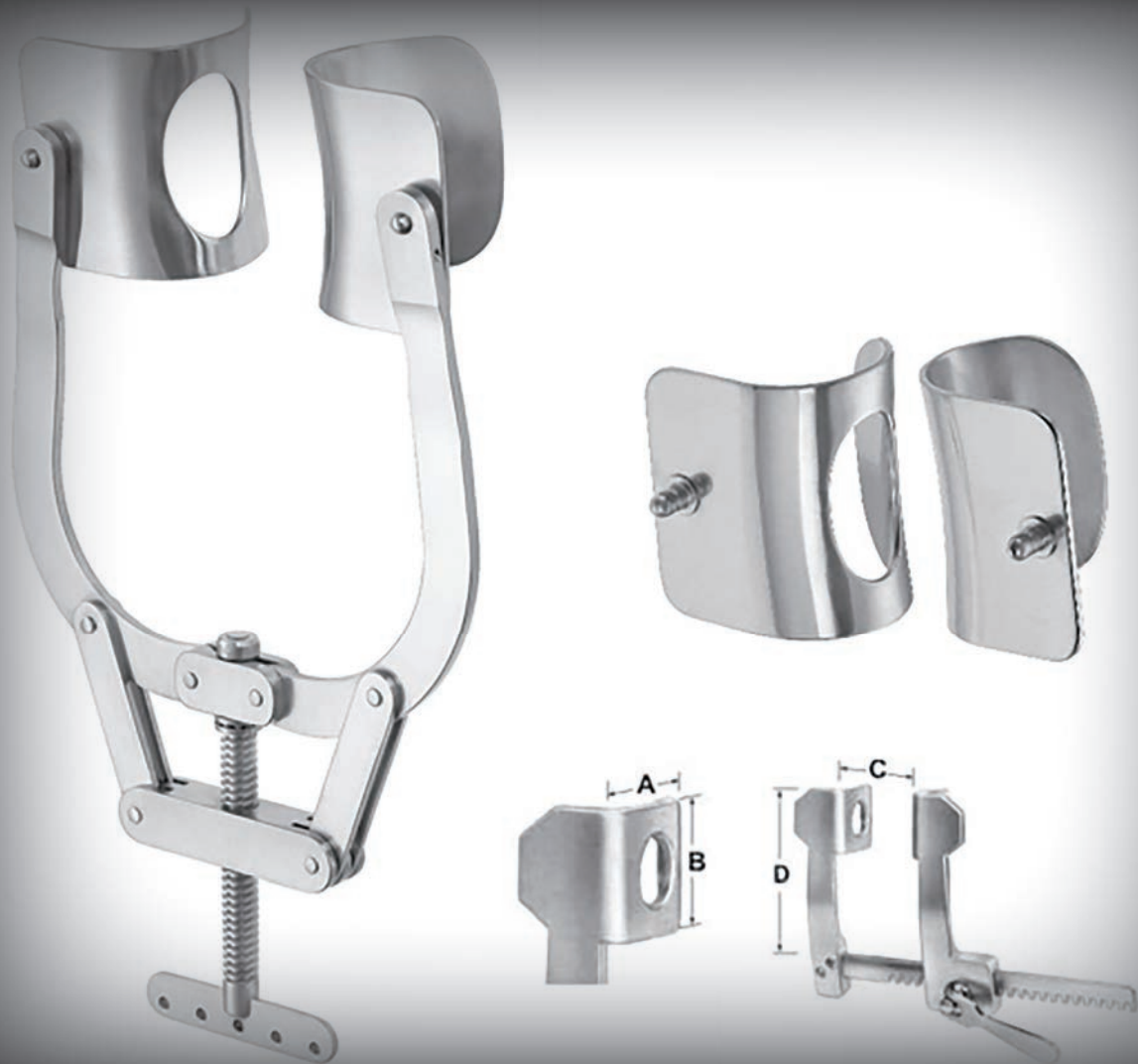

# Index

## Cardiovascular Retractors

Bailey Cardiovascular Retractor   Lemmon Cardiovascular Retractor	264
Tuffier Cardiovascular Retractor Stainless Steel	265
Badgley Cardiovascular Retractor Stainless Steel	266
Rienhoff Cardiovascular Retractor Stainless Steel	266-267
Baby Haight Cardiovascular Retractor Stainless Steel	267
Burford Cardiovascular Retractor	268
Finochietto Baby Cardiovascular Retractor	268-271
Morse Child Cardiovascular Retractor Stainless Steel	272
Favaloro-Morse Cardiovascular Retractor Stainless Steel	272
DeBakey with 3-Set of Blades Cardiovascular Retractor	273
Ankeney Child Cardiovascular Retractor Stainless Steel	274
Haight-Finochietto Cardiovascular Retractor Aluminium	274
Burford-Finochietto Cardiovascular Retractor Aluminium	275
Castaneda Cardiovascular Retractor Aluminium	276
Cooley Cardiovascular Retractor Aluminium	276
Bailey Finochietto Cardiovascular Retractor Aluminium	277
Cooley Cardiovascular Retractor Stainless Steel	277
Finochietto Micro Neonatal Cardiovascular Retractor Stainless Steel	278
Morse Neonatal Cardiovascular Retractor Black Coated	278
Titanium Mini Micro Neonatal Cardiovascular Retractor	279
Neonatal Finochietto Retractor	279
Swivel Blades Cardiovascular Retractor Stainless Steel	280
DeBakey Klein Cardiovascular Retractor Stainless Steel	282
DeBakey Grob Cardiovascular Retractor Stainless Steel	282
Harken Cardiovascular Retractor   DuBost Cardiovascular Retractor Stainless Steel	283
Morse Cardiovascular Retractor Aluminium	284-286
Finochietto-Baby-Haight Cardiovascular Retractor Aluminium	286-290
Burford Cardiovascular Retractor Aluminium	291-292
Skill Cardiovascular Retractor Aluminium   Cooley   Skill-Ankeney   Weinberg   Braastad   Struck	293-304
Skill-DeBakey Cardiovascular Retractor Stainless Steel   DuBost IMA   IMA   Cardiobase	305-308
Snap in Coupling for attachments   Morse Blades   Cooley Blades	309
Malleable Hook	310
Ross Retractor Serrated Cardiobase Retractor   Marberger Retractor Cardiobase Retractor	311
Cooley-type Rake Retractor Malleable Cardiobase Retractor	311-312

Malleable Blade Retractor Cardiobase Retractor	312
Removable Blades IMA Retractor System	313
Cooley Mitral Retractor System	314-315
IMA Couetil Retractor	316-317
Carpentier Mitral Valve Retractors	318-319
Thorax Lifting Retractor   French Model Mini IMA Retractor	320
McCarthy Mini Sternotomy Retractor System	321
Sellors Rib Spreader Stainless Steel	322
Volkmann Retractor	323-325
Koerte Retractor	326
Israel Retractor	327
Kocher Langenbeck Retractor	328
Jefferson Retractor   Valve Retractor	329
Desmarres Open Lid Retractor	330-331
Ross Retractor	332
Cooley Atrium Retractor With Serrated Teeth   Davidson Scapula Retractor	334
Copper Retractor Malleable	335
Cushing Lid Retractor	336
Kirklin Lid Retractor	337
Gill-Vernet Malleable Retractor	338
Murphy Retractor	339
Senn Miller Double Ended Retractor   Czerny Double Ended Retractor	340
Kocher Langenbeck Retractor	341-343
Ross Retractor Serrated   Marberger Retractor   Cooley-type Rake Retractor Malleable	344
Harrington Cardio Retractors	345
Deaver Retractor   DuBost Hand Retractor	346
Allison Hand Retractor	347
Memory (Nitinol) Retractor Malleable   Epicardial Retractor 3x3 Teeth	348
Alm Retractor   Weitlander Retractor	349
Anderson Adson Retractor	350
Travers Retractor   Ionescu Handheld Valve Retractor	351-352
SKILL Atraumatic Retraction System	353
SKILL Cooley Atrial Blades, Shaft Diameter, 6 mm	354
MIDCAB Retractor System Complete	355
MIDCAB Retractor System Complete Blades and Stabilizer	356
MIDCAB Retractor Only Double Joint   MIDCAB Adapter	357
MIDCAB Double Blades (solid individually)	358
SKILL MICS Aortic Clamp Set	359-361
\SKILL MICS Atrial Blade Set	362

# CARDIOVASCULAR RETRACTOR

**Bailey Cardiovascular Retractor****Description**

Bailey Retractor A = 19 mm

Bailey Paediatric Retractor A = 18 mm

Bailey Gibon Retractor A = 29 mm

**Length**

18 cm

14 cm

18 cm

**Code**

DA-1200-18

DA-1201-14

DA-1202-18

**Lemmon Cardiovascular Retractor****Description**

Lemmon Retractor for Children

Lemmon Retractor Large

**Length**

14 cm

18 cm

**Code**

DA-1205-14

DA-1206-18

**Tuffier Cardiovascular Retractor Stainless Steel**

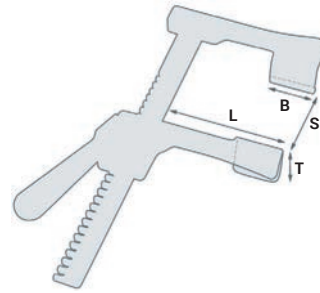

S	L	B	T
178 mm	108 mm	45 mm	48 mm

**Description**

Tuffier Retractor

**Code**

DA-1207-00

**Tuffier Cardiovascular Retractor Stainless Steel**

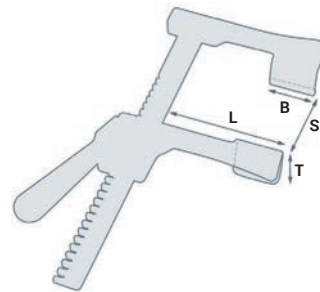

S	L	B	T
178 mm	107 mm	45 mm	48 mm

**Description**

Tuffier Retractor

**Code**

DA-1208-00

**Badgley Cardiovascular Retractor Stainless Steel**

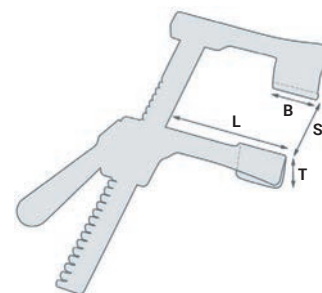

Blades with 4 prongs

S	L	B	T
165 mm	108 mm	45 mm	50 mm

**Description**

Badgley Retractor

**Code**

DA-1209-00

**Rienhoff Cardiovascular Retractor Stainless Steel**

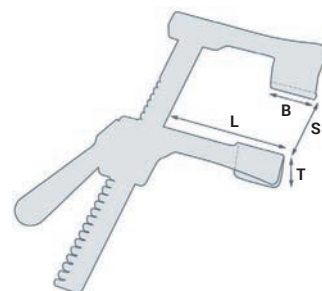

S	L	B	T
140 mm	116 mm	33 mm	30 mm

**Description**

Rienhoff Retractor

**Code**

DA-1210-00

### Rienhoff Cardiovascular Retractor Stainless Steel

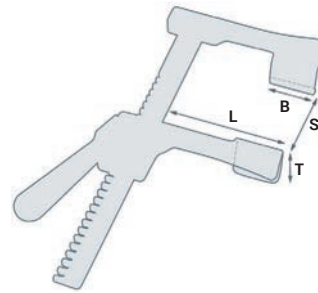

S	L	B	T
140 mm	146 mm	45 mm	47 mm

**Description**

Rienhoff Retractor

**Code**

DA-1211-00

### Baby Haight Cardiovascular Retractor Stainless Steel

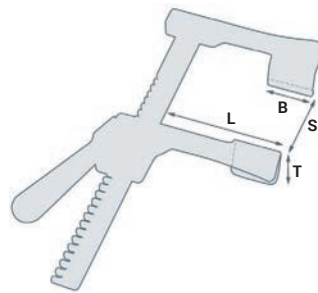

	S	L	B	T
<b>A</b>	126 mm	64 mm	31 mm	32 mm
<b>B</b>	126 mm	90 mm	31 mm	32 mm

**Description**

- A** Baby Haight Retractor
- B** Baby Haight Retractor

**Code**

- DA-1212-00
- DA-1213-00

**Burford Cardiovascular Retractor**

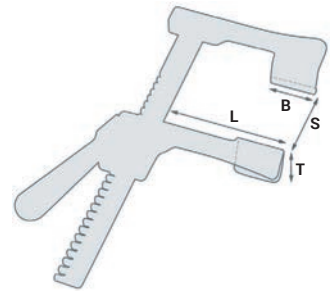
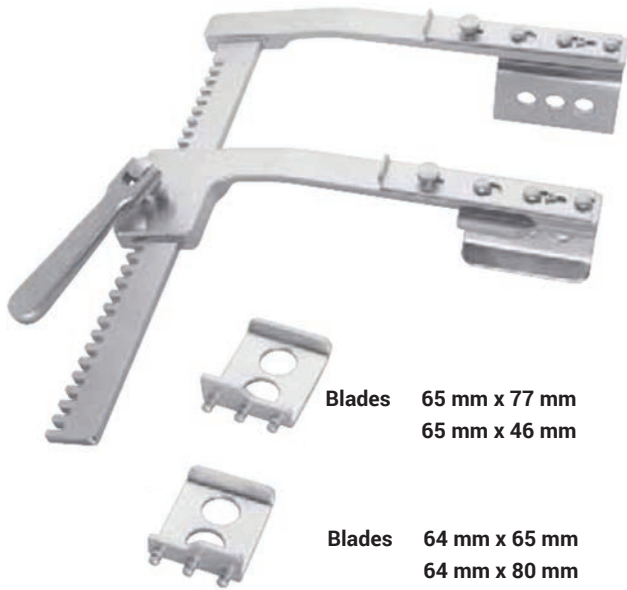

Blades 65 mm x 77 mm  
65 mm x 46 mm

Blades 64 mm x 65 mm  
64 mm x 80 mm

	S	L	B	T
A	208 mm	192 mm	65 mm	77 mm
B	200 mm	205 mm	65 mm	46 mm

**Description**

- A Burford Retractor
- B Burford Retractor

**Code**

- DA-1214-00
- DA-1215-00

**Burford-Finochietto Child Cardiovascular Retractor Stainless Steel**

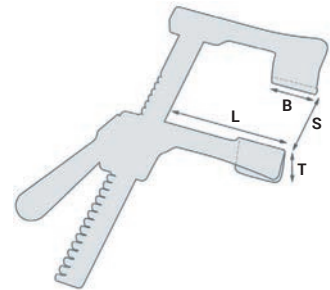
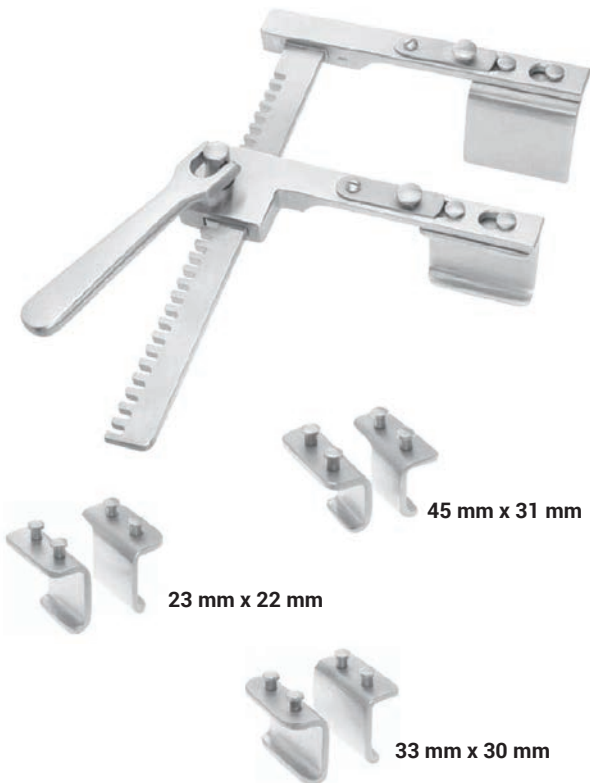

45 mm x 31 mm

23 mm x 22 mm

33 mm x 30 mm

S	L	B	T
157 mm	108 mm	44 mm	47 mm

**Description**

Burford-Finochietto Child

**Code**

DA-1216-00

**Finochietto Baby Straight Arms Cardiovascular Retractor  
Stainless Steel**

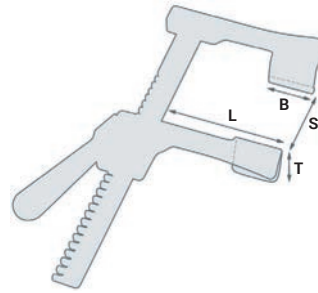

	S	L	B	T
<b>A</b>	55 mm	51 mm	15 mm	13 mm
<b>B</b>	75 mm	51 mm	15 mm	13 mm
<b>C</b>	80 mm	60 mm	21 mm	18 mm

**Description**

- A** Finochietto Baby Retractor
- B** Finochietto Baby Retractor
- C** Finochietto Baby Retractor

**Code**

- DA-1217-00
- DA-1218-00
- DA-1219-00

**Finochietto Baby Curved Arms Cardiovascular Retractor  
Stainless Steel**

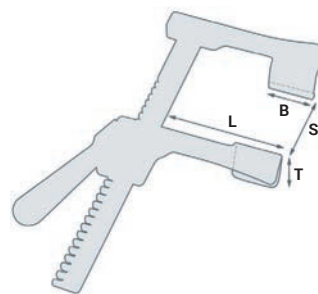

	S	L	B	T
	80 mm	60 mm	21 mm	18 mm

**Description**

Finochietto Baby Retractor

**Code**

DA-1220-00

**CARDIOVASCULAR RETRACTOR**

**Finochietto Baby Curved Arms With Circular Fenestration  
Cardiovascular Retractor Stainless Steel**

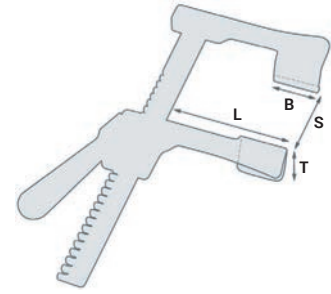

S	L	B	T
150 mm	111 mm	32 mm	28 mm

**Description**

Finochietto Baby Retractor

**Code**

DA-1221-00

**Finochietto Baby Cardiovascular Retractor Stainless Steel**

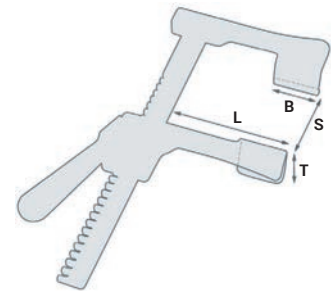

S	L	B	T
80 mm	68 mm	21 mm	19 mm

**Description**

Finochietto Baby Retractor

**Code**

DA-1222-00

### Finochietto Straight Arms Cardiovascular Retractor Stainless Steel

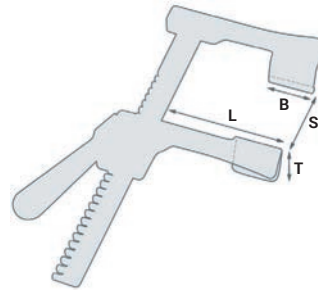

	S	L	B	T
<b>A</b>	200 mm	186 mm	66 mm	51 mm
<b>B</b>	265 mm	186 mm	66 mm	51 mm
<b>C</b>	310 mm	186 mm	66 mm	51 mm

**Description**

- A** Finochietto Retractor
- B** Finochietto Retractor
- C** Finochietto Retractor

**Code**

- DA-1223-00
- DA-1224-00
- DA-1225-00

### Finochietto Curved Arms Cardiovascular Retractor Stainless Steel

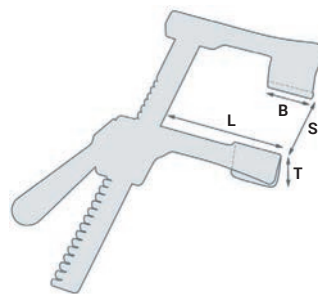

	S	L	B	T
<b>A</b>	148 mm	130 mm	45 mm	40 mm
<b>B</b>	200 mm	162 mm	65 mm	50 mm
<b>C</b>	200 mm	130 mm	65 mm	50 mm
<b>D</b>	200 mm	180 mm	65 mm	50 mm
<b>E</b>	220 mm	180 mm	65 mm	70 mm
<b>F</b>	250 mm	180 mm	65 mm	70 mm

**Description**

- A** Finochietto Retractor
- B** Finochietto Retractor
- C** Finochietto Retractor
- D** Finochietto Retractor
- E** Finochietto Retractor
- F** Finochietto Retractor

**Code**

- DA-1226-00
- DA-1227-00
- DA-1228-00
- DA-1229-00
- DA-1230-00
- DA-1231-00

CARDIOVASCULAR RETRACTOR

**Morse Child Cardiovascular Retractor Stainless Steel**

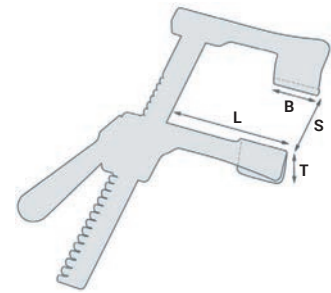

S	L	B	T
154 mm	125 mm	22 mm	15 mm

**Description**

Morse Child Retractor

**Code**

DA-1232-00

**Favaloro-Morse Cardiovascular Retractor Stainless Steel**

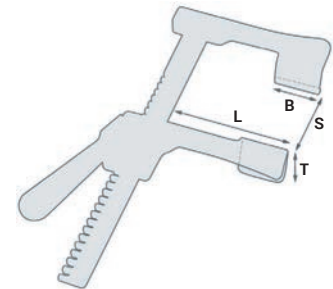

	S	L	B	T
<b>A</b>	212 mm	148 mm	29 mm	23 mm
<b>B</b>	212 mm	148 mm	29 mm	38 mm
<b>C</b>	212 mm	205 mm	29 mm	38 mm
<b>D</b>	170 mm	148 mm	29 mm	34 mm

**Description**

- A** Morse Retractor
- B** Favaloro-Morse Retractor
- C** Favaloro-Morse Retractor
- D** Pacifico-Morse Retractor

**Code**

- DA-1233-00
- DA-1234-00
- DA-1235-00
- DA-1236-00

**DeBakey with 3-Set of Blades Cardiovascular Retractor  
Stainless Steel**

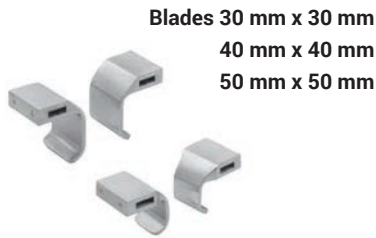
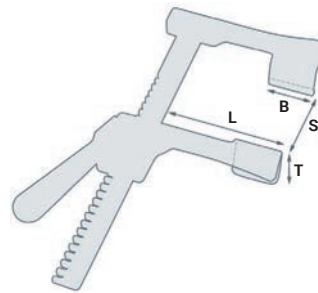
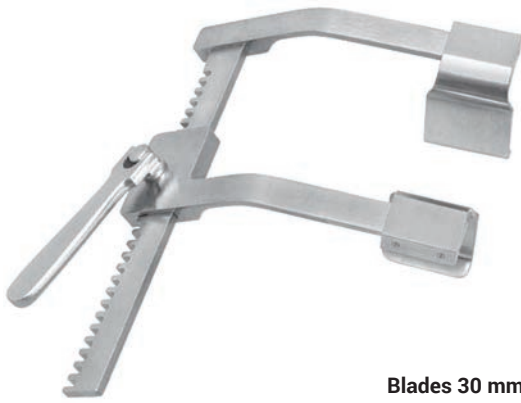

Blades 30 mm x 30 mm  
40 mm x 40 mm  
50 mm x 50 mm

S	L	B	T
192 mm	153 mm	40 mm	40 mm

**Description**

DeBakey Retractor

**Code**

DA-1237-00

**DeBakey with 3-Set of Blades Cardiovascular Retractor  
Stainless Steel**

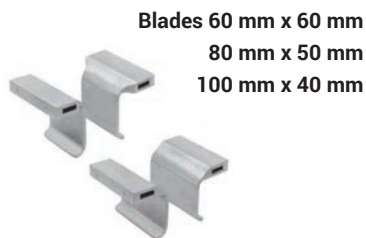
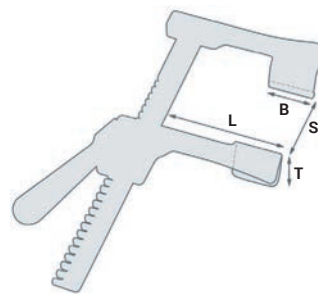
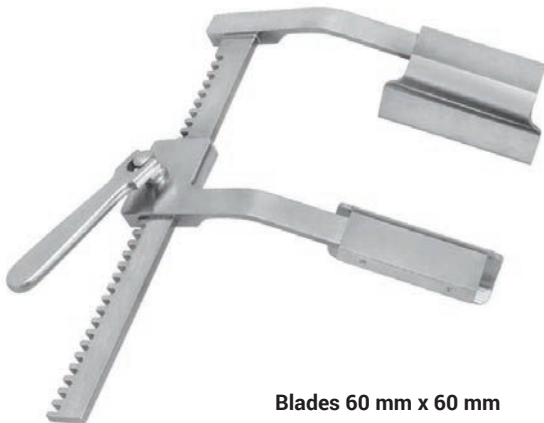

Blades 60 mm x 60 mm  
80 mm x 50 mm  
100 mm x 40 mm

S	L	B	T
240 mm	170 mm	60 mm	60 mm

**Description**

DeBakey Retractor

**Code**

DA-1238-00

CARDIOVASCULAR RETRACTOR

**Ankeney Child Cardiovascular Retractor Stainless Steel**

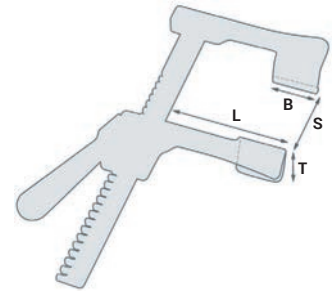

	S	L	B	T
<b>A</b>	139 mm	114 mm	19 mm	23 mm
<b>B</b>	195 mm	289 mm	35 mm	35 mm

**Description**

Ankeney Retractor  
Ankeney Retractor

**Code**

DA-1239-00  
DA-1240-00

**Haight-Finochietto Cardiovascular Retractor Aluminium**

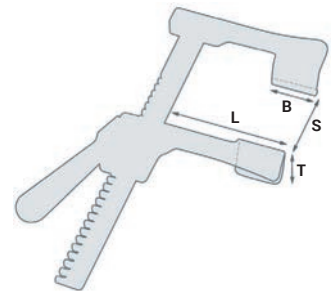

S	L	B	T
98 mm	76 mm	31 mm	31 mm

**Description**

Haight-Finochietto Retractor

**Code**

DA-1241-00

### Burford-Finochietto Cardiovascular Retractor Aluminium

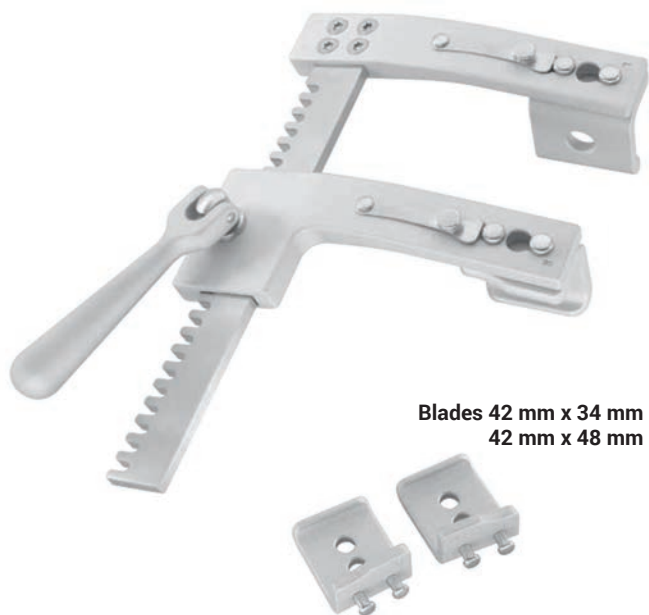

Blades 42 mm x 34 mm  
42 mm x 48 mm

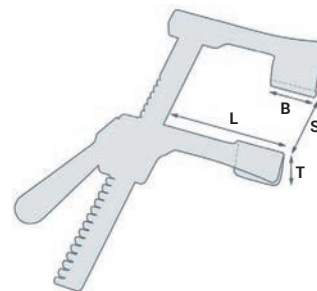

S	L	B	T
135 mm	113 mm	42 mm	48 mm

**Description**

Burford-Finochietto Retractor

**Code**

DA-1242-00

### Burford-Finochietto Cardiovascular Retractor Aluminium

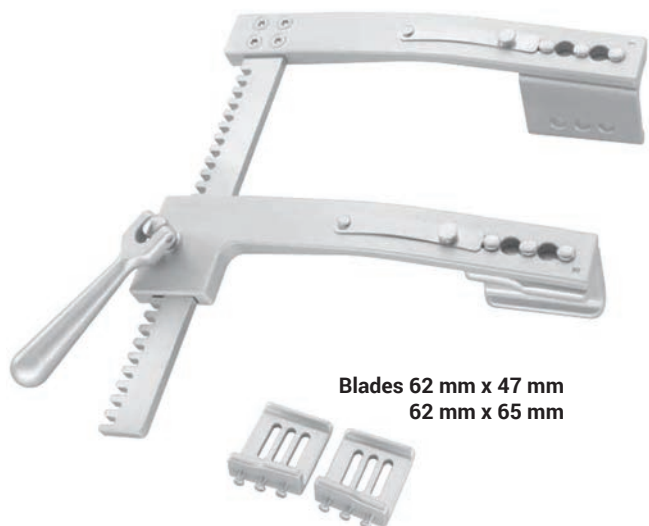

Blades 62 mm x 47 mm  
62 mm x 65 mm

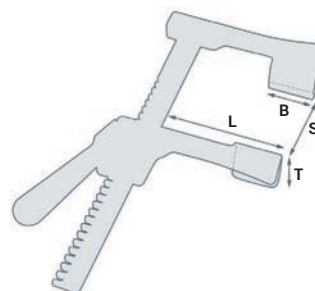

	S	L	B	T
<b>A</b>	200 mm	197 mm	62 mm	47 mm
<b>B</b>	288 mm	197 mm	62 mm	47 mm
<b>C</b>	330 mm	197 mm	62 mm	47 mm

**Description**

- A** Burford-Finochietto Retractor
- B** Burford-Finochietto Retractor
- C** Burford-Finochietto Retractor

**Code**

- DA-1243-00
- DA-1244-00
- DA-1245-00

CARDIOVASCULAR RETRACTOR

**Castaneda Cardiovascular Retractor Aluminium**

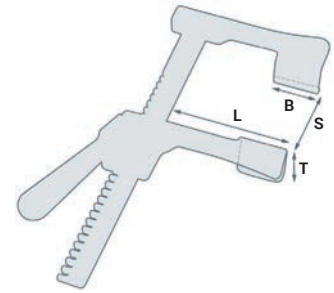

	<b>S</b>	<b>L</b>	<b>B</b>	<b>T</b>
<b>A</b>	74 mm	60 mm	34 mm	11 mm
<b>B</b>	80 mm	80 mm	45 mm	13 mm
<b>C</b>	110 mm	126 mm	60 mm	17 mm

**Description**

- A** Castaneda Retractor
- B** Castaneda Retractor
- C** Castaneda Retractor

**Code**

- DA-1246-00
- DA-1247-00
- DA-1248-00

**Cooley Cardiovascular Retractor Aluminium**

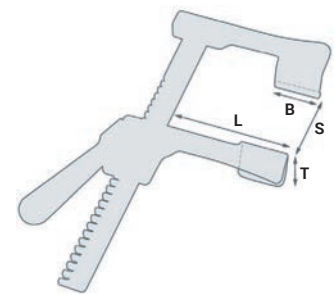

	<b>S</b>	<b>L</b>	<b>B</b>	<b>T</b>
<b>A</b>	74 mm	58 mm	17 mm	11 mm
<b>B</b>	101 mm	80 mm	30 mm	17 mm
<b>C</b>	74 mm	58 mm	17 mm	13 mm

**Description**

- A** Cooley Neonatal Retractor
- B** Cooley Small Child Retractor
- C** Cooley Child Retractor

**Code**

- DA-1249-00
- DA-1250-00
- DA-1251-00

### Bailey Finochietto Cardiovascular Retractor Aluminium

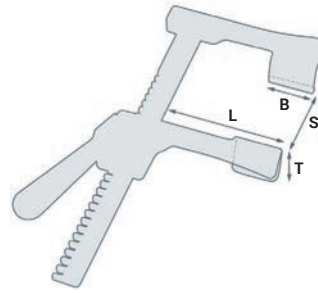

S	L	B	T
74 mm	58 mm	14 mm	12 mm

**Description**

Bailey Finochietto Retractor

**Code**

DA-1252-00

### Cooley Cardiovascular Retractor Stainless Steel

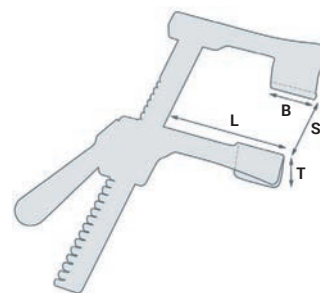

	S	L	B	T
<b>A</b>	137 mm	112 mm	46 mm	25 mm
<b>B</b>	170 mm	140 mm	52 mm	34 mm

**Description**

- A** Cooley Retractor
- B** Cooley Retractor

**Code**

- DA-1253-00
- DA-1254-00

CARDIOVASCULAR RETRACTOR

**Finochietto Micro Neonatal Cardiovascular Retractor  
Stainless Steel**

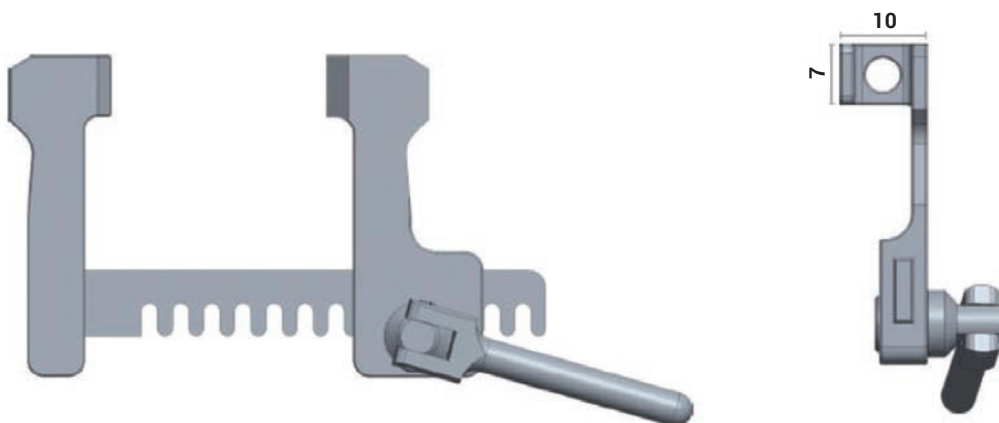

S	L	B	T
32 mm	59 mm	10 mm	7 mm

**Description**

Finocietto Retractor

**Code**

DA-3050-00

**Morse Neonatal Cardiovascular Retractor Black Coated**

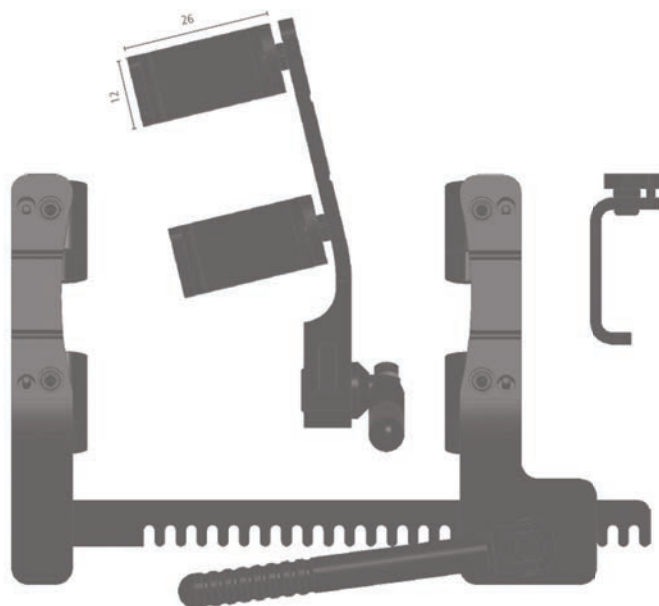

S	L	B	T
65 mm	109 mm	40 mm	12 mm

**Description**

Morse Neonatal Cardiovascular Retractor

**Code**

DA-3077-00

**Titanium Mini Micro Neonatal Cardiovascular Retractor**



	Overall Length	Overall Height	Max. Spread
<b>A</b>	77 mm	53 mm	39 mm



Full Blades

	Blade Depth	Blade Width	Type
<b>B</b>	15 mm	20 mm	Right
	15 mm	20 mm	Left

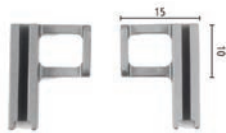

Fenstered Blades

	Blade Depth	Blade Width	Type
<b>B</b>	15 mm	20 mm	Right
	15 mm	20 mm	Left

**Description**

- A** Titanium Mini Micro Neonatal complete with Full Blades
- B** Titanium Mini Micro Neonatal complete with Fenstered Blades

**Code**

- DA-3160-01T
- DA-3160-02T

**Neonatal Fiochietto Retractor**



S	L	B	T
6 mm	7 mm	37 mm	25 mm

**Description**

Neonatal Fiochietto Retractor

**Code**

DA-3170-00

Swivel Blades Cardiovascular Retractor Stainless Steel

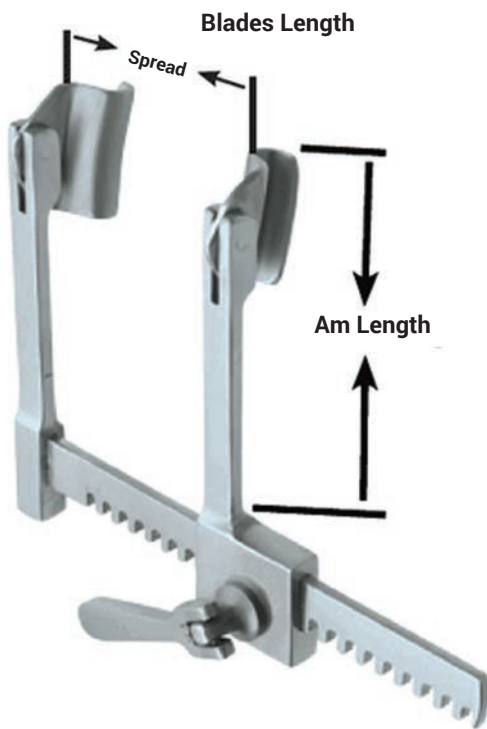
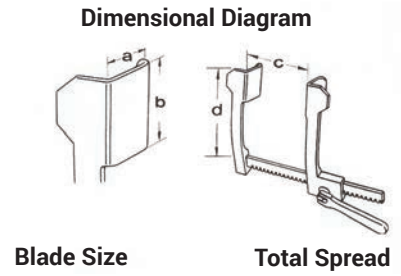
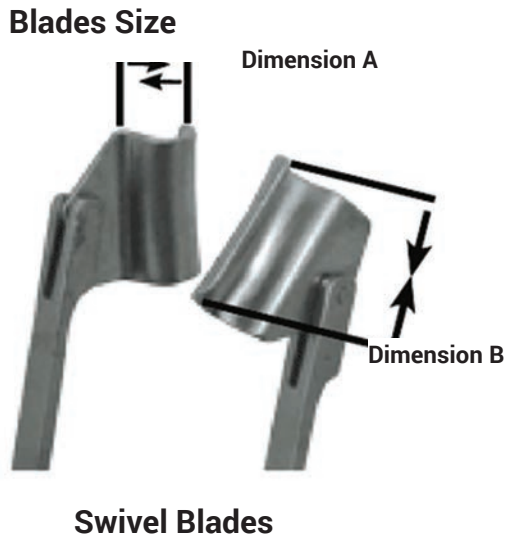

**Skill Turn-Over Retractor Neonatal**

With turn-over function of retractor body.

	A	B	C	D
A	20 mm	28 mm	65 mm	65 mm

**Skill Turn-Over Retractor Infant**

With turn-over function of retractor body.

	A	B	C	D
B	14 mm	45 mm	80 mm	75 mm

**Skill Turn-Over Retractor Small-Child**

With turn-over function of retractor body.

	A	B	C	D
C	18 mm	58 mm	90 mm	85 mm

**Description**

- A Swivel Blades Cardiovascular Retractor
- B Swivel Blades Cardiovascular Retractor
- C Swivel Blades Cardiovascular Retractor

**Code**

- DA-3170-01
- DA-3170-02
- DA-3170-03



# CARDIOVASCULAR RETRACTOR

## DeBakey Klein Cardiovascular Retractor Stainless Steel

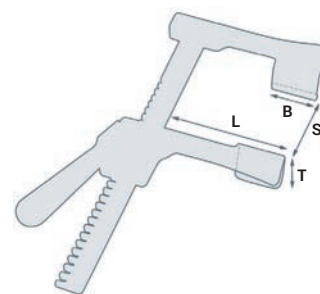

S	L	B	T
152 mm	144 mm	30 mm	30 mm

**Description**

DeBakey Klein Retractor

**Code**

DA-1255-00

## DeBakey Grob Cardiovascular Retractor Stainless Steel

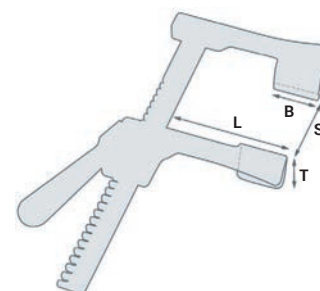
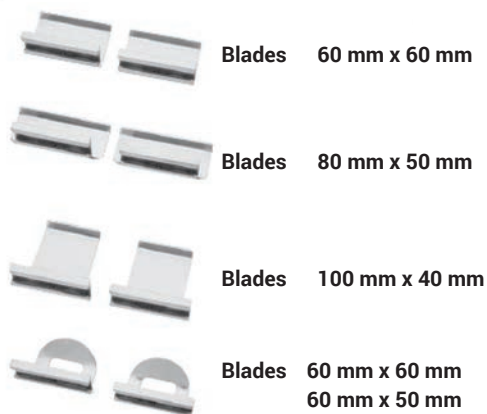

S	L	B	T
241 mm	189 mm	80 mm	50 mm

**Description**

DeBakey Grob Retractor

**Code**

DA-1256-00

### Harken Cardiovascular Retractor

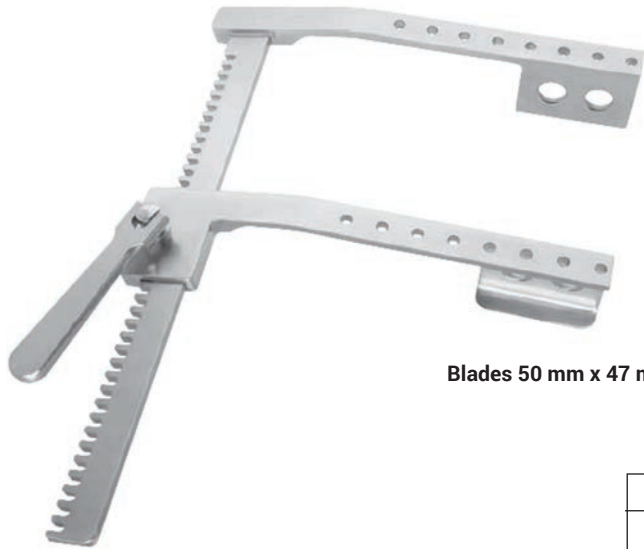

Blades 50 mm x 47 mm

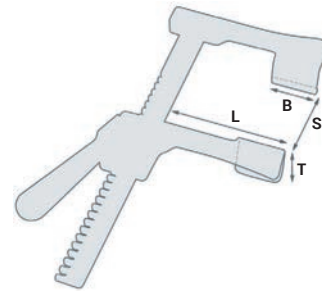

S	L	B	T
280 mm	210 mm	65 mm	49 mm

**Description**

Harken Retractor

**Code**

DA-1257-00

### DuBost Cardiovascular Retractor Stainless Steel



Blades 100 mm x 30 mm



Blades 100 mm x 50 mm

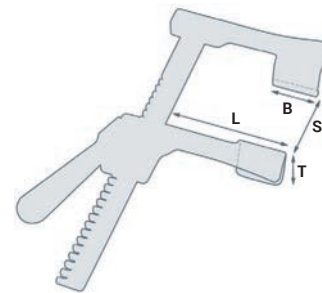

S	L	B	T
160 mm	140 mm	100 mm	40 mm

**Description**

DuBost Retractor

**Code**

DA-1258-00

**Morse Cardiovascular Retractor Aluminium**



**Dimensional Diagram**

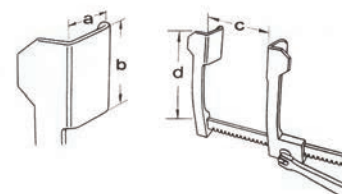

**Blade Size**

**Total Spread**

**Morse Sternal**

With double swivel blades, for adults, distance between blades 72 mm, arms curved between rack and blades. Aluminium natural grey.

Like Morse Sternal but arms curved between blades.

A	B	C	D
20 mm	28 mm	210 mm	155 mm

**Description**

Morse Cardiovascular Retractor Aluminium

**Code**

DA-1400-00

**Morse Cardiovascular Retractor Aluminium**



**Dimensional Diagram**

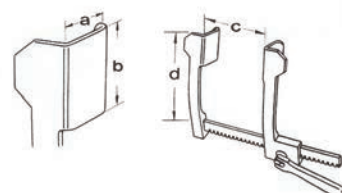

**Blade Size**

**Total Spread**

**Morse Sternal**

With double swivel blades, for children, distance between blades 50 mm, arms curved between rack and blades. Aluminium natural grey.

Like Morse Sternal but arms curved between blades.

A	B	C	D
20 mm	20 mm	155 mm	120 mm

**Description**

Morse Cardiovascular Retractor Aluminium

**Code**

DA-1401-00

**Morse-Favaloro Cardiovascular Retractor Aluminium**

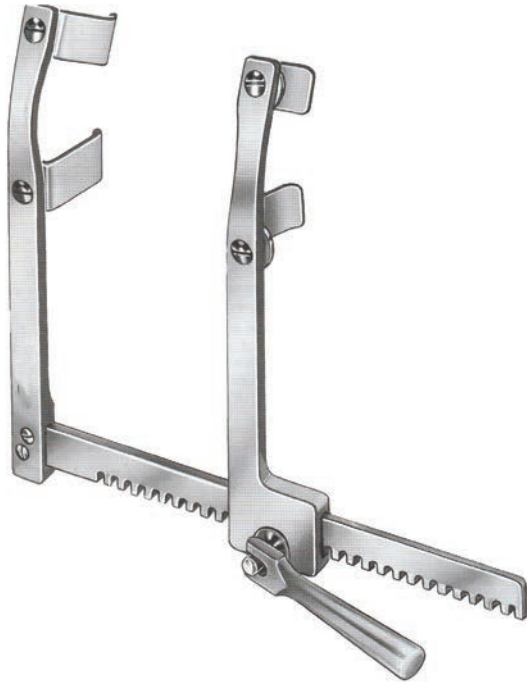

Dimensional Diagram

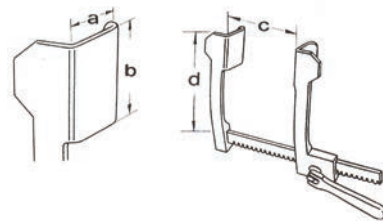

Blade Size

Total Spread

**Morse-Favaloro Sternal**

For adults, with double swivel blades, distance between blades 65 mm, arms curved between blades. Aluminium natural grey.

A	B	C	D
40 mm	20 mm	155 mm	175 mm

**Description**

Morse-Favaloro Cardiovascular Retractor Aluminium

**Code**

DA-1402-00

**Morse-Favaloro Cardiovascular Retractor Aluminium**

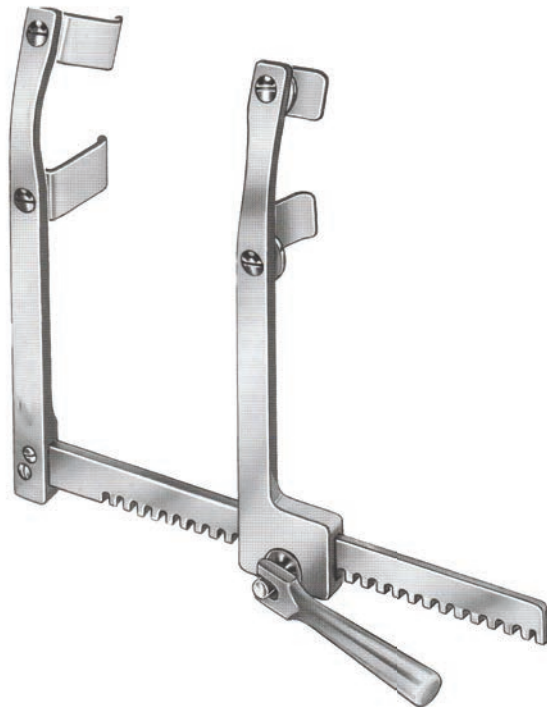

Dimensional Diagram

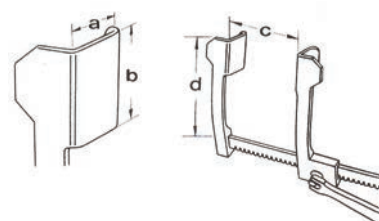

Blade Size

Total Spread

**Morse-Favaloro Sternal**

For children, with double swivel blades, distance between blades 50 mm, arms curved between blades. Aluminium natural grey.

A	B	C	D
40 mm	20 mm	155 mm	175 mm

**Description**

Morse-Favaloro Cardiovascular Retractor Aluminium

**Code**

DA-1403-00

**Skill-Morse Cardiovascular Retractor Aluminium**



Dimensional Diagram

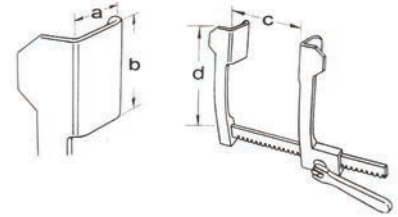

Blade Size

Total Spread

**Skill-Morse Sternal**

For adults, modified by Skill, extra large, with 3 pairs of swivel blades, distance between blades 42 mm. Aluminium natural grey.

A	B	C	D
30 mm	35 mm	200 mm	195 mm

**Description**

Skill-Morse Cardiovascular Retractor Aluminium

**Code**

DA-1404-00

**Finochietto-Baby-Haight Cardiovascular Retractor Aluminium**

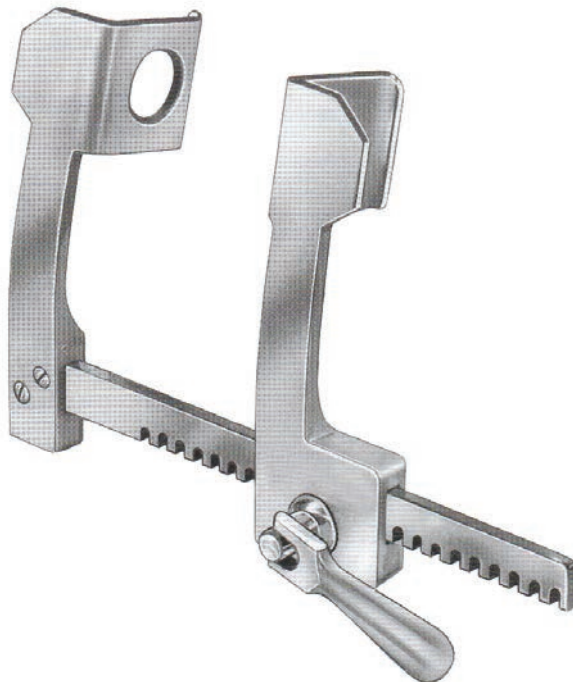

Dimensional Diagram

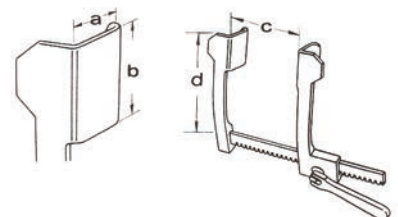

Blade Size

Total Spread

**Finochietto-Baby-Haight**

Child size. Aluminium natural grey.

A	B	C	D
27 mm	30 mm	95 mm	80 mm

**Description**

Finochietto-Baby-Haight Cardiovascular Retractor Aluminium

**Code**

DA-1405-00

### Finochietto-Infant Cardiovascular Retractor Aluminium

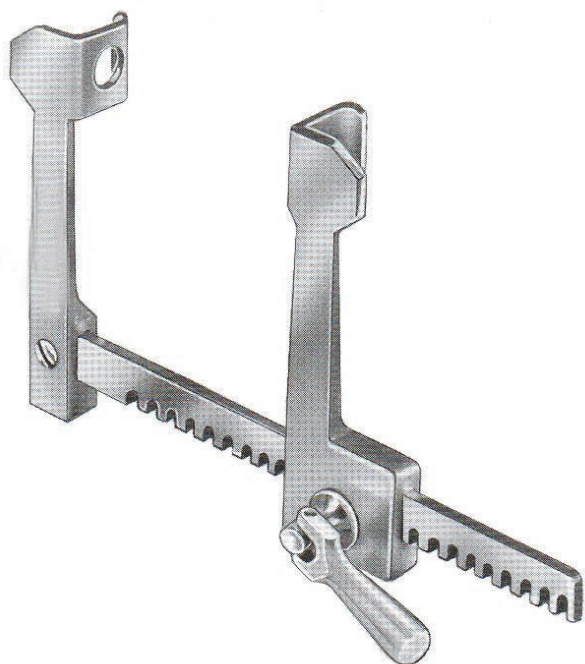

Dimensional Diagram

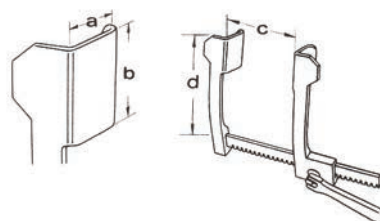

Blade Size

Total Spread

**Finochietto-Infant**  
 Infant size.  
 Aluminium natural grey.

A	B	C	D
12 mm	15 mm	70 mm	55 mm

**Description**

Finochietto-Infant Cardiovascular Retractor Aluminium

**Code**

DA-1406-00

### Skill-Finochietto Cardiovascular Retractor Aluminium

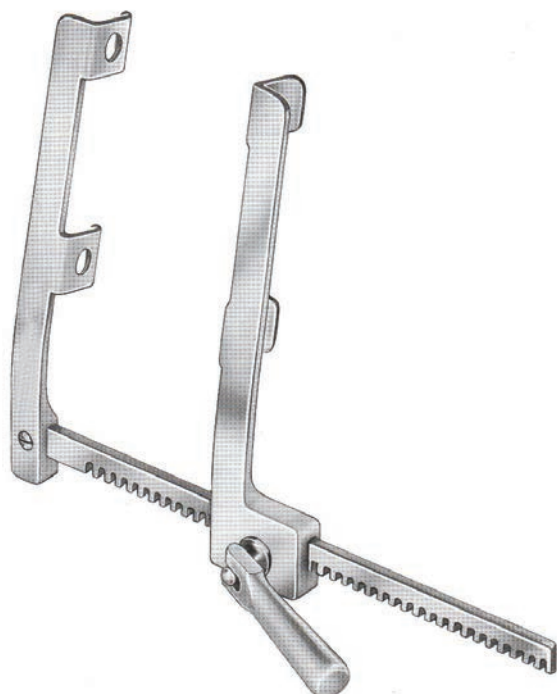

Dimensional Diagram

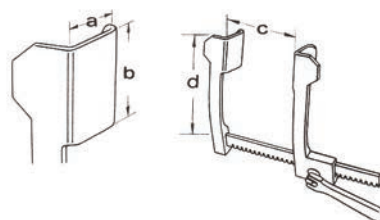

Blade Size

Total Spread

**Skill-Finochietto**  
 Infant size. Two blades attached to each arm,  
 40 mm distance between blades.  
 Aluminium natural grey.

A	B	C	D
10 mm	15 mm	120 mm	105 mm

**Description**

Skill-Finochietto Cardiovascular Retractor Aluminium

**Code**

DA-1407-00

**Finochietto Cardiovascular Retractor Aluminium**

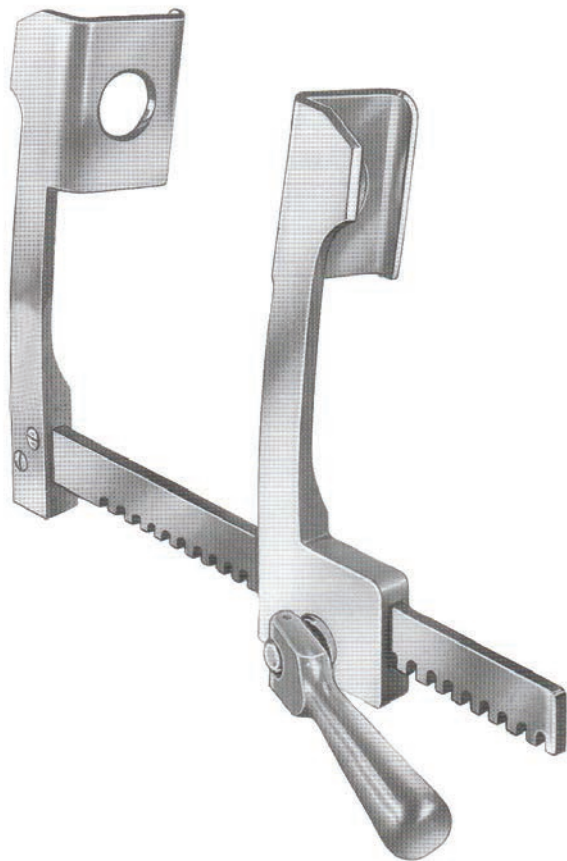

**Dimensional Diagram**

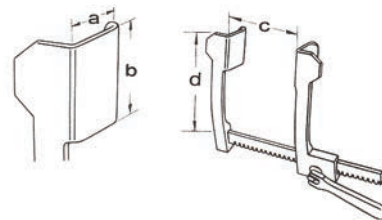

**Blade Size**

**Total Spread**

**Finochietto**

Small size for children too.  
Aluminium natural grey.

A	B	C	D
30 mm	45 mm	140 mm	110 mm

**Description**

Finochietto Cardiovascular Retractor Aluminium

**Code**

DA-1408-00



## Finochietto Cardiovascular Retractor Aluminium

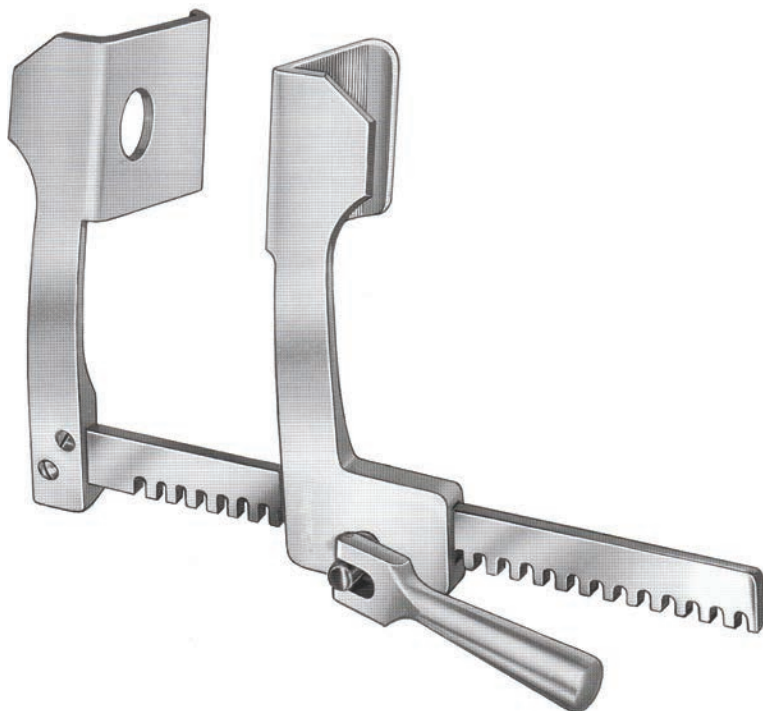

Dimensional Diagram

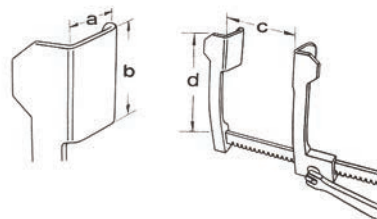

Blade Size

Total Spread

**Finochietto**

Large size for adults.  
Aluminium natural grey.

A	B	C	D
73 mm	65 mm	170 mm	140 mm

**Description**

Finochietto Cardiovascular Retractor Aluminium

**Code**

DA-1409-00

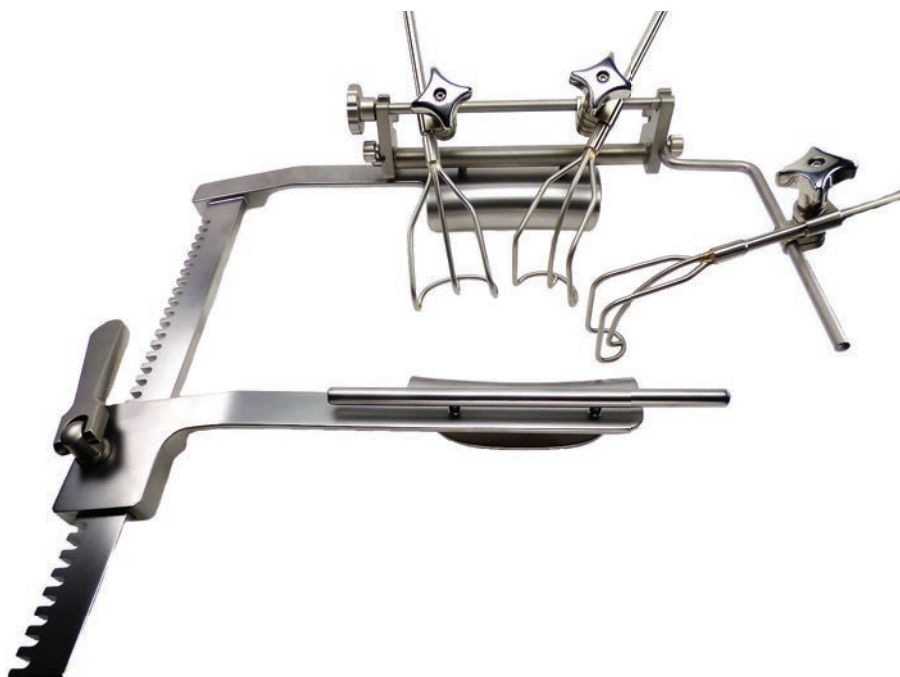

CARDIOVASCULAR RETRACTOR

**Finochietto Cardiovascular Retractor Aluminium**

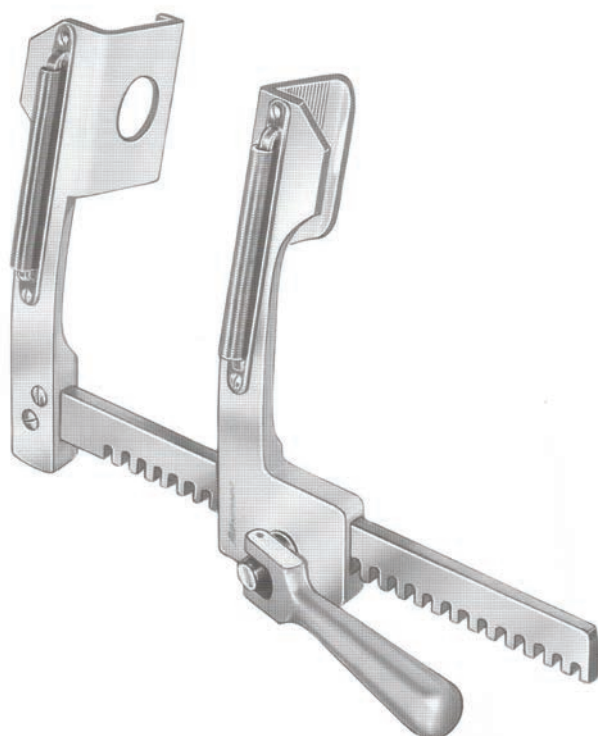

**Dimensional Diagram**

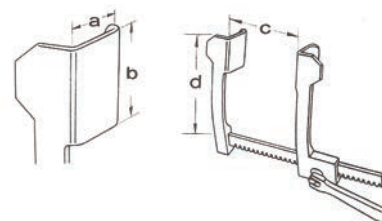

**Blade Size**

**Total Spread**

**Finochietto**

Medium size for adults with suture separator.  
Aluminium natural grey.

A	B	C	D
42 mm	62 mm	170 mm	140 mm

**Description**

Finochietto Cardiovascular Retractor Aluminium

**Code**

DA-1410-00

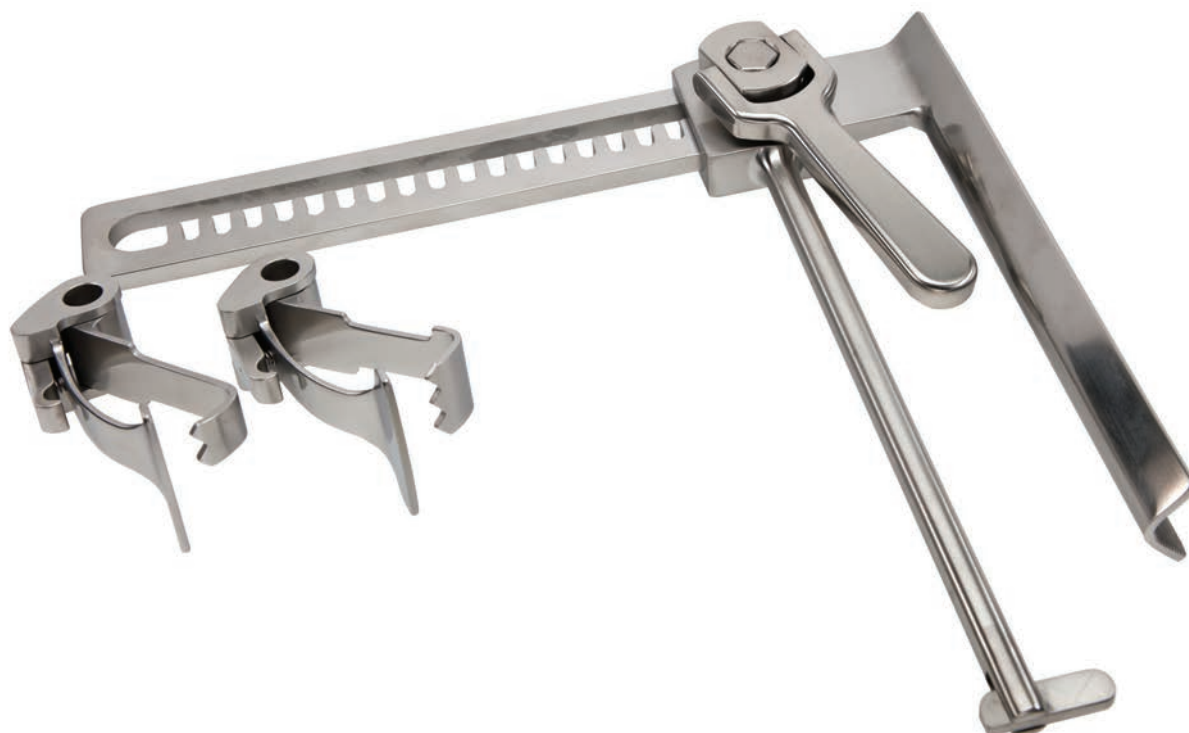

**Burford Cardiovascular Retractor Aluminium**

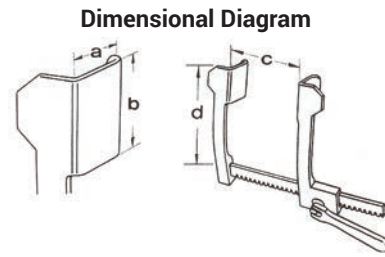
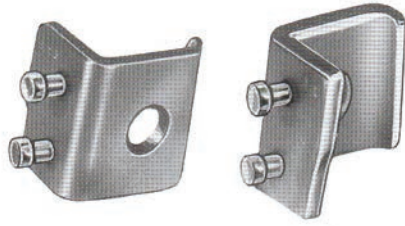

Blade Size

Total Spread



**Burford**

Child size, with two pairs of interchangeable blades, small and large. Aluminium natural grey.

A1	B1	A2	B2	C	D
30 mm	42 mm	41 mm	42 mm	130 mm	117 mm

**Pair of Blades**

A	B
30 mm	42 mm
41 mm	42 mm

**Description**

Burford Cardiovascular Retractor Aluminium

Burford Cardiovascular Retractor Aluminium Pair of Blades 30 mm, 42 mm

Burford Cardiovascular Retractor Aluminium Pair of Blades 41 mm, 42 mm

**Code**

DA-1411-00

DA-1412-00

DA-1413-00



CARDIOVASCULAR RETRACTOR

# CARDIOVASCULAR RETRACTOR

## Burford Cardiovascular Retractor Aluminium



Dimensional Diagram

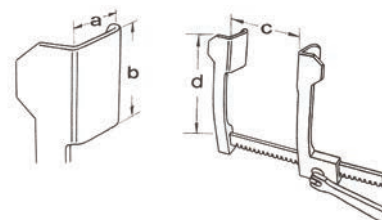

Blade Size

Total Spread

### Burford 165 mm

Adult size, with two pairs of interchangeable blades, small and large.  
Aluminium natural grey.

A1	B1	A2	B2	C	D
45 mm	62 mm	65 mm	62 mm	165 mm	200 mm

### Burford 250 mm

Standard size for adults with two pairs of interchangeable blades, small and large.  
Aluminium natural grey.

A1	B1	A2	B2	C	D
45 mm	62 mm	65 mm	62 mm	250 mm	200 mm

### Burford 290 mm

For adults with two pairs of interchangeable blades, small and large.  
Aluminium natural grey.

A1	B1	A2	B2	C	D
45 mm	62 mm	62 mm	62 mm	290 mm	200 mm

### Pair of Blades

A	B
45 mm	62 mm
65 mm	62 mm

### Description

Burford Cardiovascular Retractor Aluminium 165 mm

Burford Cardiovascular Retractor Aluminium 250 mm

Burford Cardiovascular Retractor Aluminium 290 mm

Burford Cardiovascular Retractor Aluminium Pair of Blades 45 mm, 62 mm

Burford Cardiovascular Retractor Aluminium Pair of Blades 65 mm, 62 mm

### Code

DA-1444-00

DA-1445-00

DA-1446-00

DA-1447-00

DA-1448-00

**Skill Cardiovascular Retractor Aluminium**



**Dimensional Diagram**

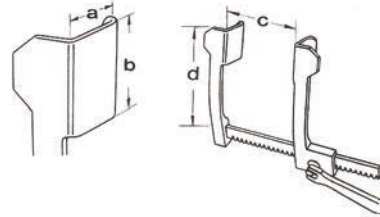

**Blade Size**

**Total Spread**

**Skill Sternal**

Neonatal, with concave-convex blades.  
Aluminium natural grey.

A	B	C	D
16 mm	30 mm	65 mm	55 mm

**Description**

Skill Cardiovascular Retractor Aluminium

**Code**

DA-1449-00

**Skill Cardiovascular Retractor Aluminium**

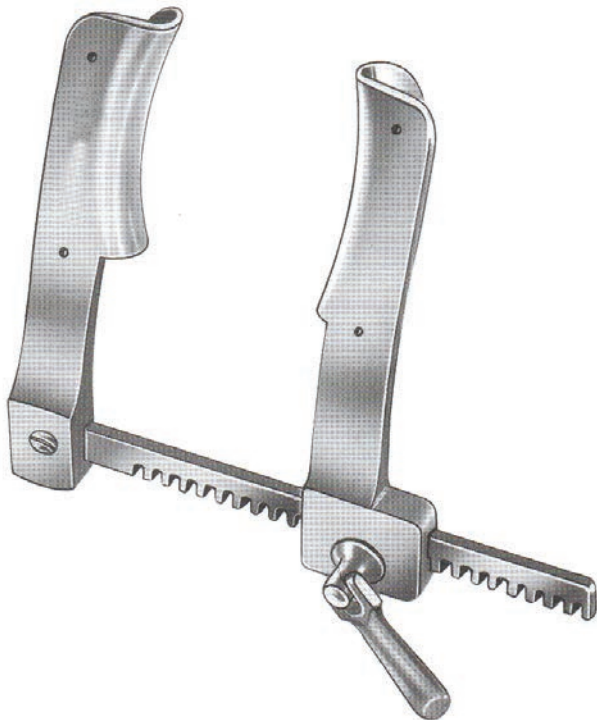

**Dimensional Diagram**

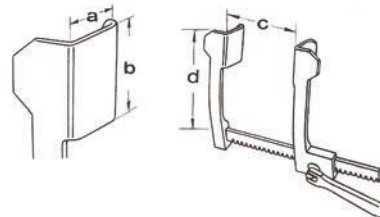

**Blade Size**

**Total Spread**

**Skill Sternal**

For babies with concave-convex blades.  
Aluminium natural grey.

A	B	C	D
12 mm	45 mm	72 mm	80 mm

**Description**

Skill Cardiovascular Retractor Aluminium

**Code**

DA-1450-00

# CARDIOVASCULAR RETRACTOR

## Skill Cardiovascular Retractor Aluminium

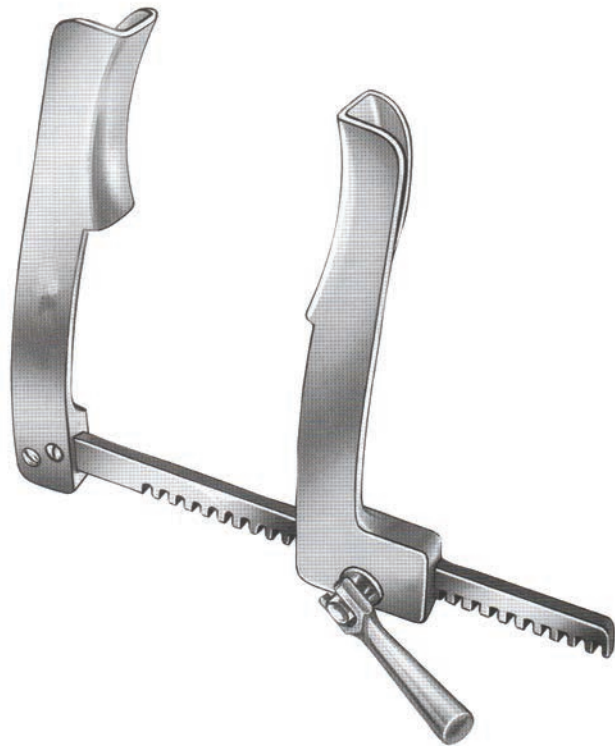

Dimensional Diagram

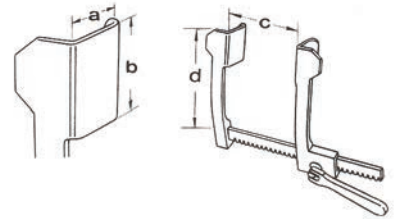

Blade Size

Total Spread

### Skill Sternal

Child size with concave-convex blades.  
Aluminium natural grey.

A	B	C	D
15 mm	60 mm	100 mm	125 mm

**Description**

Skill Cardiovascular Retractor Aluminium

**Code**

DA-1451-00

## Skill Cooley Cardiovascular Retractor Aluminium



Dimensional Diagram

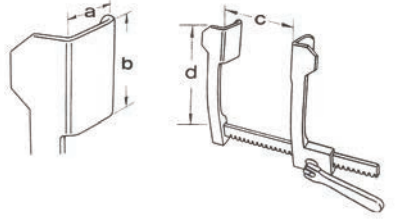

Blade Size

Total Spread

### Skill Cooley

With swivel convex blades for babies.  
Aluminium natural grey.

A	B	C	D
10 mm	15 mm	90 mm	75 mm

**Description**

Skill Cooley Cardiovascular Retractor Aluminium

**Code**

DA-1452-00

**Skill Cooley Cardiovascular Retractor Aluminium**



Dimensional Diagram

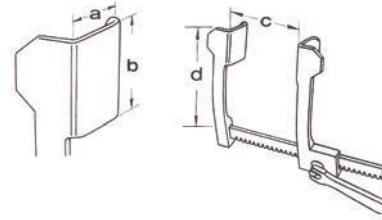

Blade Size

Total Spread

**Skill Cooley**

With swivel blades for babies.  
Aluminium natural grey.

A	B	C	D
10 mm	15 mm	90 mm	75 mm

**Description**

Skill Cooley Cardiovascular Retractor Aluminium

**Code**

DA-1453-00

**Cooley Cardiovascular Retractor Aluminium**

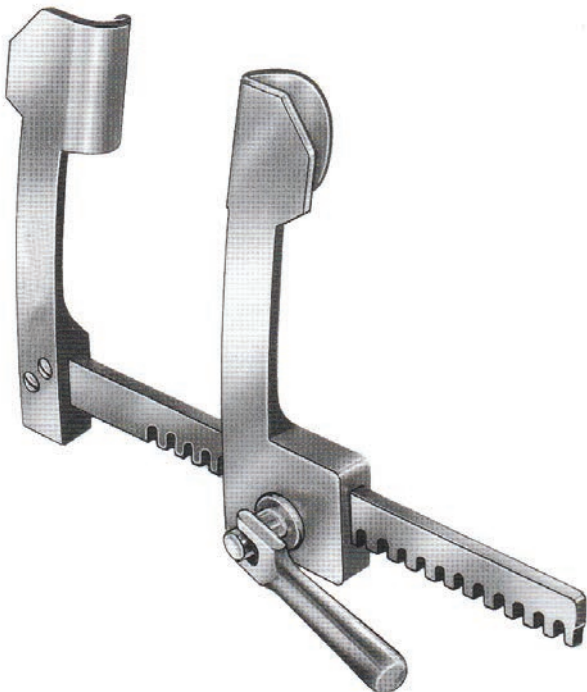

Dimensional Diagram

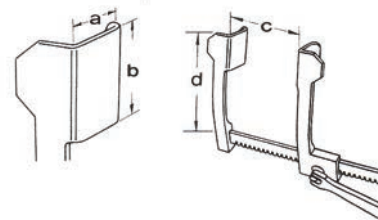

Blade Size

Total Spread

**Cooley**

Paediatric size, sternal spreader,  
light-weight but sturdy.  
Aluminium natural grey.

A	B	C	D
15 mm	30 mm	115 mm	80 mm

**Description**

Cooley Cardiovascular Retractor Aluminium

**Code**

DA-1454-00

# CARDIOVASCULAR RETRACTOR

## Cooley Cardiovascular Retractor Aluminium



Dimensional Diagram

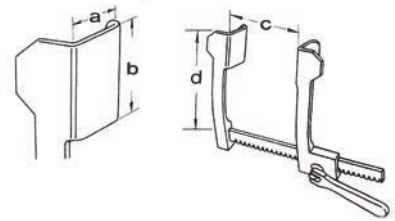

Blade Size

Total Spread

**Cooley**  
Neonatal size.  
Aluminium natural grey.

A	B	C	D
14 mm	16 mm	85 mm	55 mm

**Description**

Cooley Cardiovascular Retractor Aluminium

**Code**

DA-1455-00

## Cooley Cardiovascular Retractor Aluminium



Dimensional Diagram

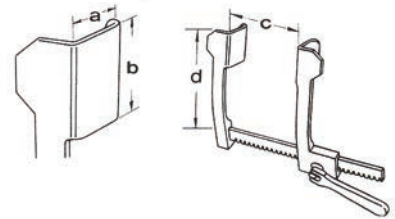

Blade Size

Total Spread

**Cooley**  
Infant size, Sternal spreader.  
Aluminium natural grey.

A	B	C	D
15 mm	20 mm	100 mm	80 mm

**Description**

Cooley Cardiovascular Retractor Aluminium

**Code**

DA-1456-00

### Skill-Ankeney Cardiovascular Retractor Aluminium

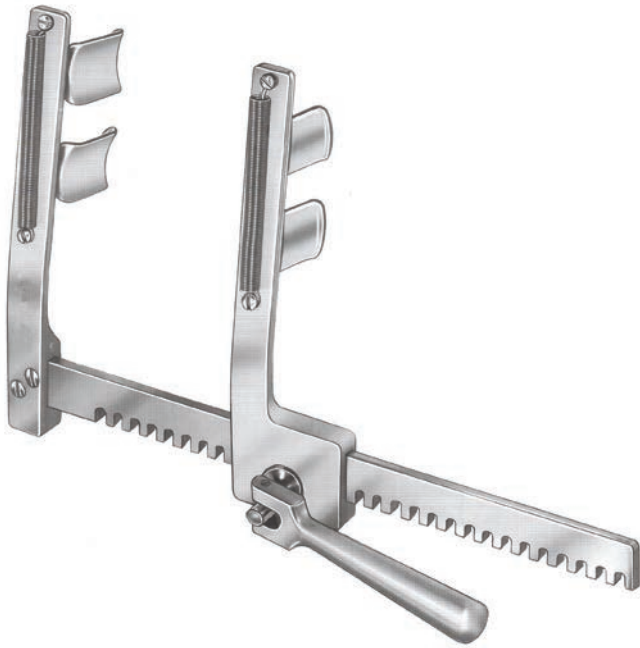

Dimensional Diagram

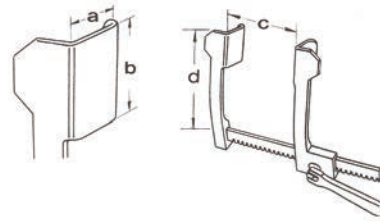

Blade Size

Total Spread

**Skill-Ankeney**

Child size, with double swivel blades, distance blades 30 mm, suture separator Aluminium natural grey.

A	B	C	D
20 mm	20 mm	160 mm	115 mm

**Description**

Skill-Ankeney Cardiovascular Retractor Aluminium

**Code**

DA-1457-00

### Cooley Cardiovascular Retractor Aluminium



Dimensional Diagram

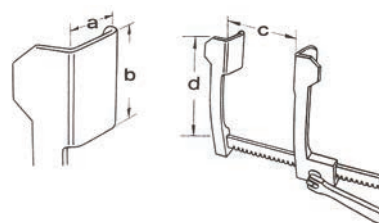

Blade Size

Total Spread

**Cooley**

For adults, standard size, modified by Skill. Aluminium natural grey.

A	B	C	D
30 mm	50 mm	185 mm	145 mm

**Description**

Cooley Cardiovascular Retractor Aluminium

**Code**

DA-1458-00

**Cooley Cardiovascular Retractor Aluminium**



**Dimensional Diagram**

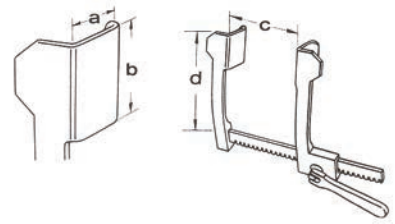

**Blade Size**

**Total Spread**

**Cooley**

For children, modified by Skill.  
Aluminium natural grey.

A	B	C	D
20 mm	45 mm	140 mm	110 mm

**Description**

Cooley Cardiovascular Retractor Aluminium

**Code**

DA-1459-00

**Cooley Cardiovascular Retractor Aluminium**

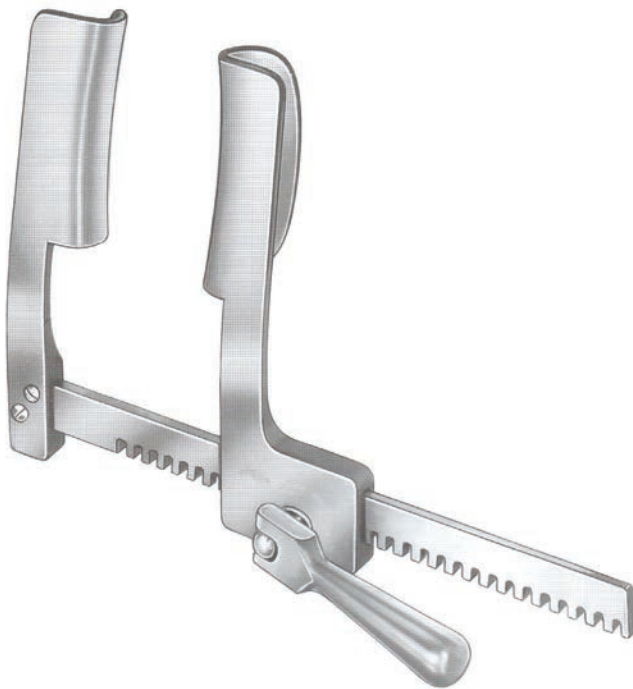

**Dimensional Diagram**

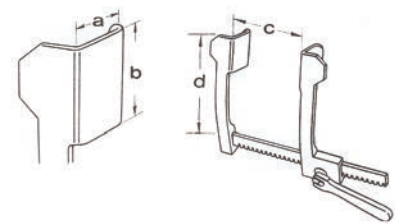

**Blade Size**

**Total Spread**

**Cooley**

Adult size, modified by Skill.  
Aluminium natural grey.

A	B	C	D
35 mm	100 mm	180 mm	180 mm

**Description**

Cooley Cardiovascular Retractor Aluminium

**Code**

DA-1460-00

**Cooley Cardiovascular Retractor Aluminium**



Dimensional Diagram

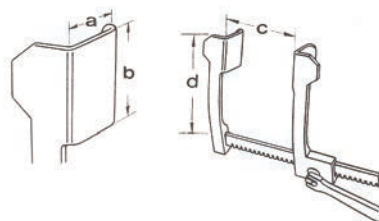

Blade Size

Total Spread

**Cooley**  
Adult size, suture separator, modified by Skill.  
Aluminium natural grey.

A	B	C	D
35 mm	100 mm	180 mm	180 mm

**Description**

Cooley Cardiovascular Retractor Aluminium

**Code**

DA-1461-00

**Cooley Cardiovascular Retractor Aluminium**



Dimensional Diagram

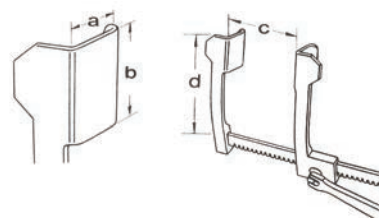

Blade Size

Total Spread

**Cooley**  
Extra large, adult size.  
Aluminium natural grey.

A	B	C	D
35 mm	115 mm	230 mm	205 mm

**Description**

Cooley Cardiovascular Retractor Aluminium

**Code**

DA-1462-00

**Cooley Cardiovascular Retractor Aluminium**



Dimensional Diagram

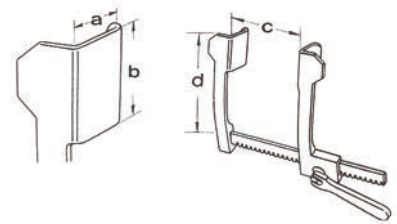

Blade Size

Total Spread

**Cooley**  
Neonatal.  
Aluminium natural grey.

A	B	C	D
12 mm	15 mm	70 mm	55 mm

**Description**

Cooley Cardiovascular Retractor Aluminium

**Code**

DA-1463-00

**Weinberg Cardiovascular Retractor Aluminium**



Dimensional Diagram

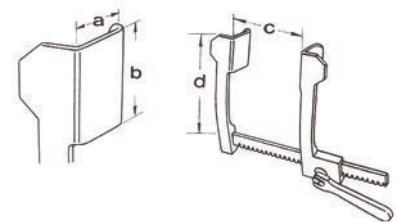

Blade Size

Total Spread

**Weinberg**  
For children, modified by Skill.  
Aluminium natural grey.

A	B	C	D
12 mm	20 mm	95 mm	75 mm

**Description**

Weinberg Cardiovascular Retractor Aluminium

**Code**

DA-1464-00

**Cooley Cardiovascular Retractor Aluminium**



**Dimensional Diagram**

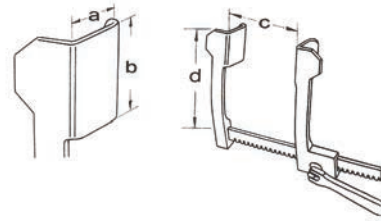

**Blade Size**

**Total Spread**

**Cooley**  
Child size.  
Aluminium natural grey.

A	B	C	D
20 mm	25 mm	100 mm	80 mm

**Description**

Cooley Cardiovascular Retractor Aluminium

**Code**

DA-1465-00

**Cooley Cardiovascular Retractor Aluminium**

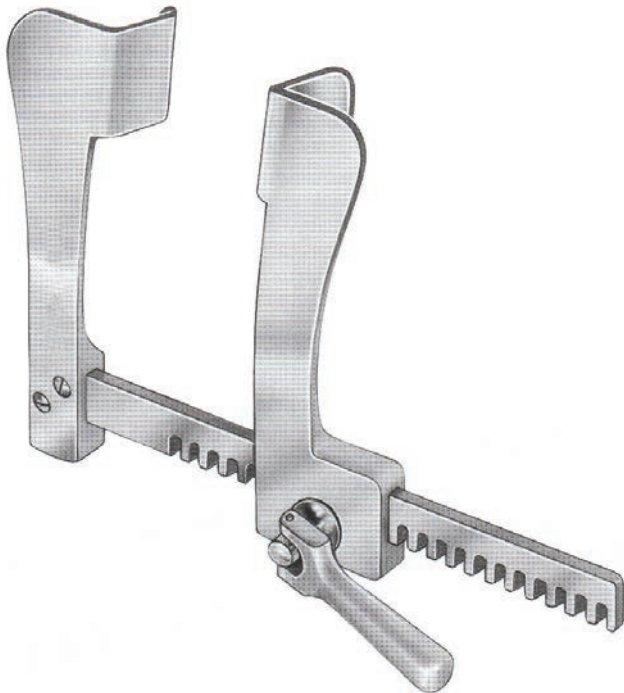

**Dimensional Diagram**

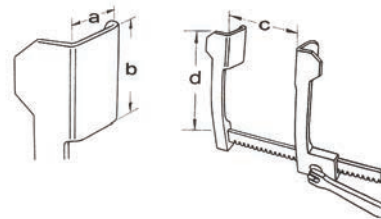

**Blade Size**

**Total Spread**

**Cooley**  
For babies.  
Aluminium natural grey.

A	B	C	D
20 mm	25 mm	100 mm	80 mm

**Description**

Cooley Cardiovascular Retractor Aluminium

**Code**

DA-1466-00

# CARDIOVASCULAR RETRACTOR

## Braastad Cardiovascular Retractor Aluminium

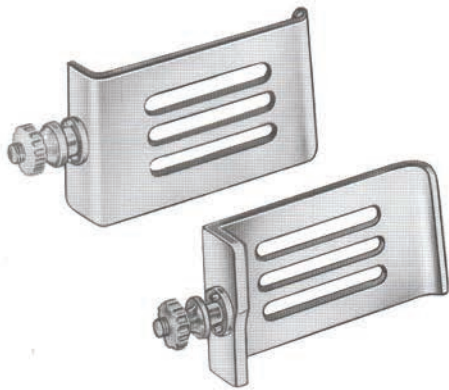

Dimensional Diagram

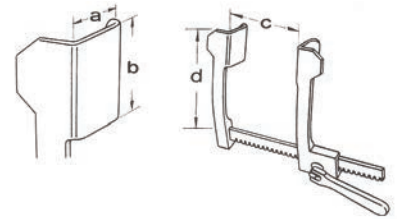

Blade Size

Total Spread

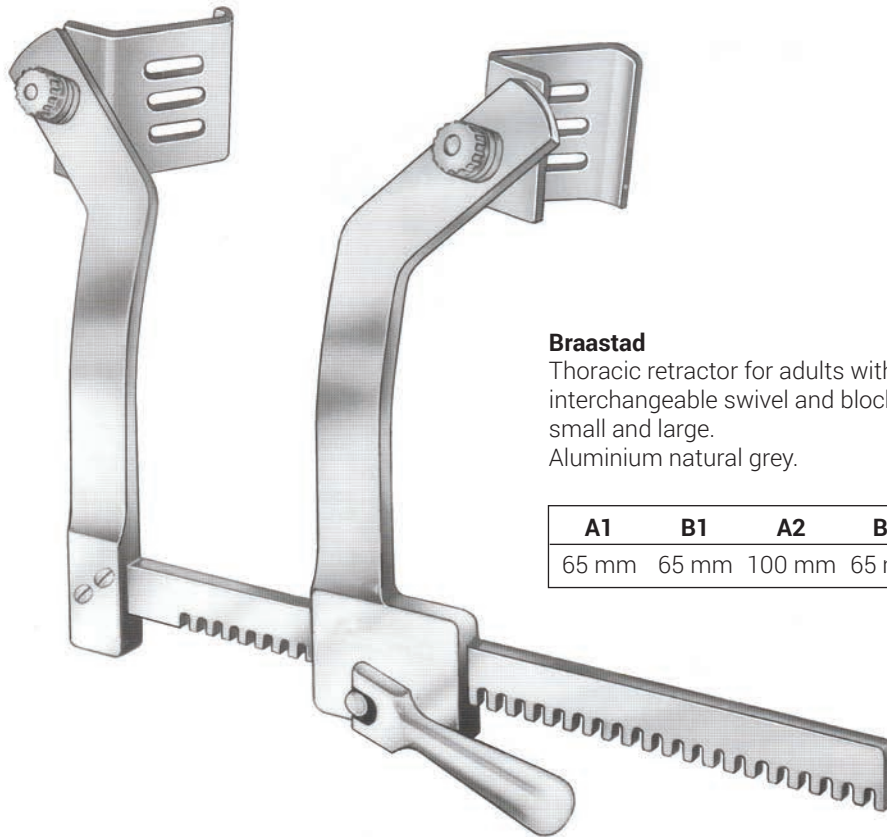

**Braastad**

Thoracic retractor for adults with two pairs of interchangeable swivel and blockable blades, small and large. Aluminium natural grey.

A1	B1	A2	B2	C	D
65 mm	65 mm	100 mm	65 mm	330 mm	210 mm

**Pair of Blades**

A	B
65 mm	65 mm
100 mm	65 mm

**Description**

Braastad Cardiovascular Retractor Aluminium

Braastad Cardiovascular Retractor Aluminium Pair of Blades 65 mm x 65 mm

Braastad Cardiovascular Retractor Aluminium Pair of Blades 100 mm x 65 mm

**Code**

DA-1467-00

DA-1468-00

DA-1469-00

Struck Cardiovascular Retractor Stainless Steel



Dimensional Diagram

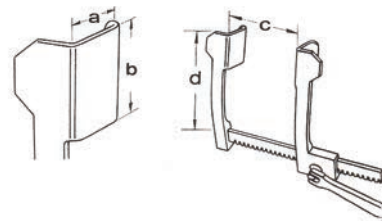

Blade Size

Total Spread

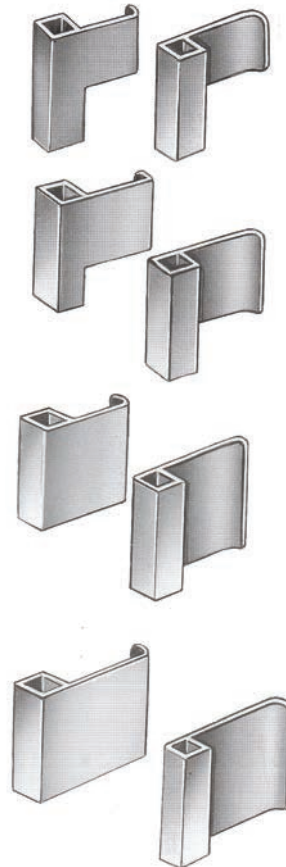

**Struck**

Infant size with two pairs of detachable blades, small and large.

A1	B1	A2	B2	C	D
15 mm	20 mm	20 mm	20 mm	70 mm	55 mm

A	B
15 mm	20 mm
20 mm	20 mm
10 mm	20 mm
10 mm	15 mm

**Description**

Struck Cardiovascular Retractor Stainless Steel

Struck Cardiovascular Retractor Stainless Steel Pair of Blades 15 mm x 20 mm

Struck Cardiovascular Retractor Stainless Steel Pair of Blades 20 mm x 20 mm

Struck Cardiovascular Retractor Stainless Steel Pair of Blades 10 mm x 20 mm

Struck Cardiovascular Retractor Stainless Steel Pair of Blades 10 mm x 15 mm

**Code**

DA-1470-00

DA-1471-00

DA-1472-00

DA-1473-00

DA-1474-00

# CARDIOVASCULAR RETRACTOR

## Cooley Cardiovascular Retractor Stainless Steel



Dimensional Diagram

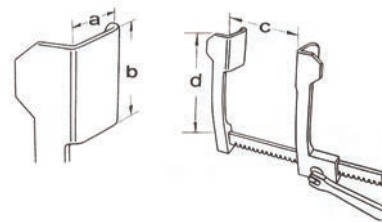

Blade Size

Total Spread

**Cooley**

Adult size, extra large with stable concave-convex blades.

A	B	C	D
35 mm	110 mm	230 mm	205 mm

**Cooley**

For adults, standard size, modified by Skill.

A	B	C	D
35 mm	100 mm	180 mm	165 mm

**Description**

Cooley Cardiovascular Retractor Stainless Steel Adult Size

Cooley Cardiovascular Retractor Stainless Steel Standard Size

**Code**

DA-1475-00

DA-1476-00

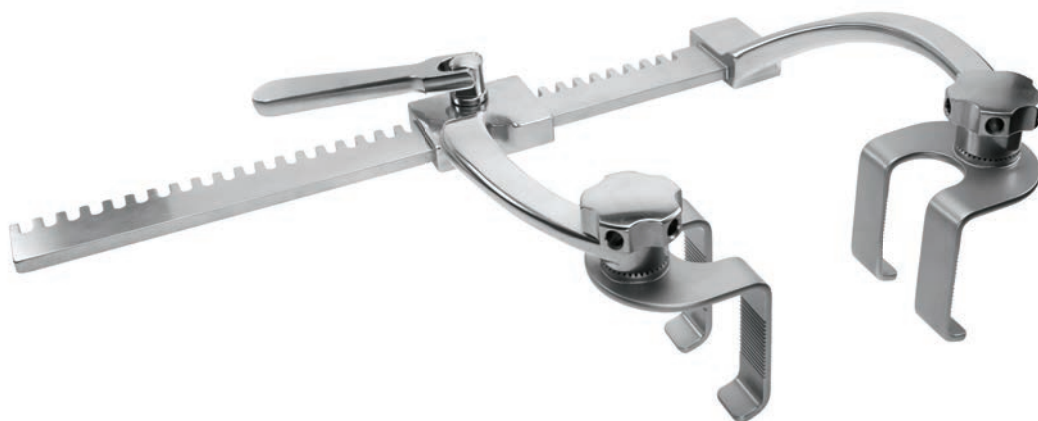

**Skill-DeBakey Cardiovascular Retractor Stainless Steel**

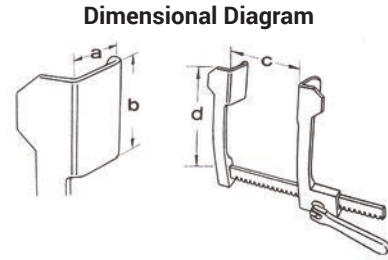

Blade Size

Total Spread

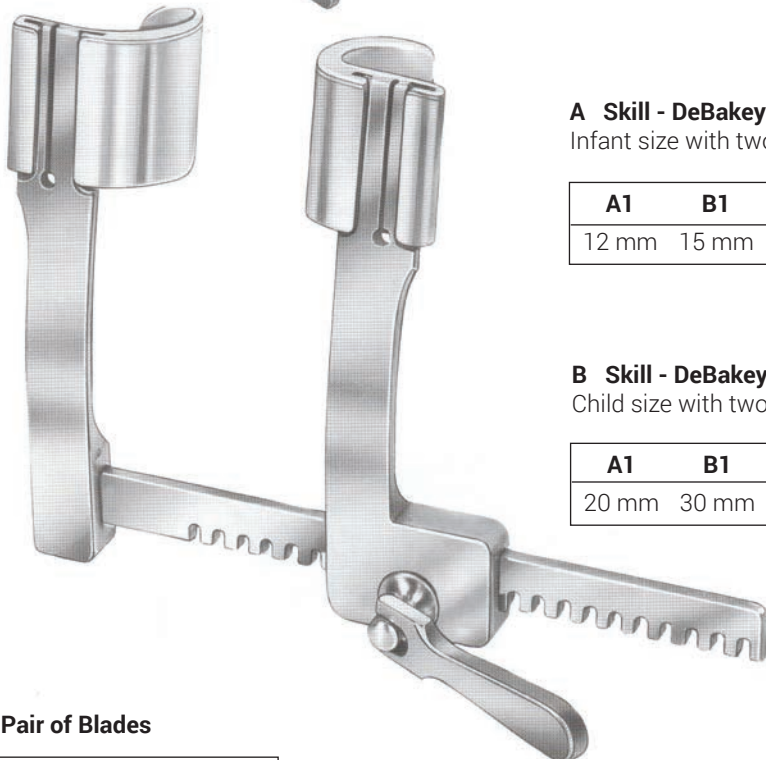

**A Skill - DeBakey**

Infant size with two pairs of interchangeable blades.

A1	B1	A2	B2	C	D
12 mm	15 mm	15 mm	15 mm	70 mm	90 mm

**B Skill - DeBakey**

Child size with two pairs of interchangeable blades.

A1	B1	A2	B2	C	D
20 mm	30 mm	30 mm	30 mm	120 mm	130 mm

**Pair of Blades**

A	B
12 mm	15 mm
15 mm	15 mm
20 mm	30 mm
30 mm	30 mm
30 mm	60 mm
48 mm	60 mm

**C Skill - DeBakey**

Adult size with two pairs of interchangeable blades.

A1	B1	A2	B2	C	D
30 mm	60 mm	48 mm	60 mm	200 mm	190 mm

**Description**

**A** Skill - DeBakey Cardiovascular Retractor Stainless Steel

**B** Skill - DeBakey Cardiovascular Retractor Stainless Steel

**C** Skill - DeBakey Cardiovascular Retractor Stainless Steel

Skill - DeBakey Cardiovascular Retractor Aluminium Pair of Blades 12 mm x 15 mm

Skill - DeBakey Cardiovascular Retractor Aluminium Pair of Blades 15 mm x 15 mm

Skill - DeBakey Cardiovascular Retractor Aluminium Pair of Blades 20 mm x 30 mm

Skill - DeBakey Cardiovascular Retractor Aluminium Pair of Blades 30 mm x 30 mm

Skill - DeBakey Cardiovascular Retractor Aluminium Pair of Blades 30 mm x 60 mm

Skill - DeBakey Cardiovascular Retractor Aluminium Pair of Blades 48 mm x 60 mm

**Code**

DA-1477-00A

DA-1477-00B

DA-1477-00C

DA-1478-00

DA-1479-00

DA-1480-00

DA-1481-00

DA-1482-00

DA-1483-00

CARDIOVASCULAR RETRACTOR

# CARDIOVASCULAR RETRACTOR

## DuBost IMA Cardiovascular Retractor Stainless Steel

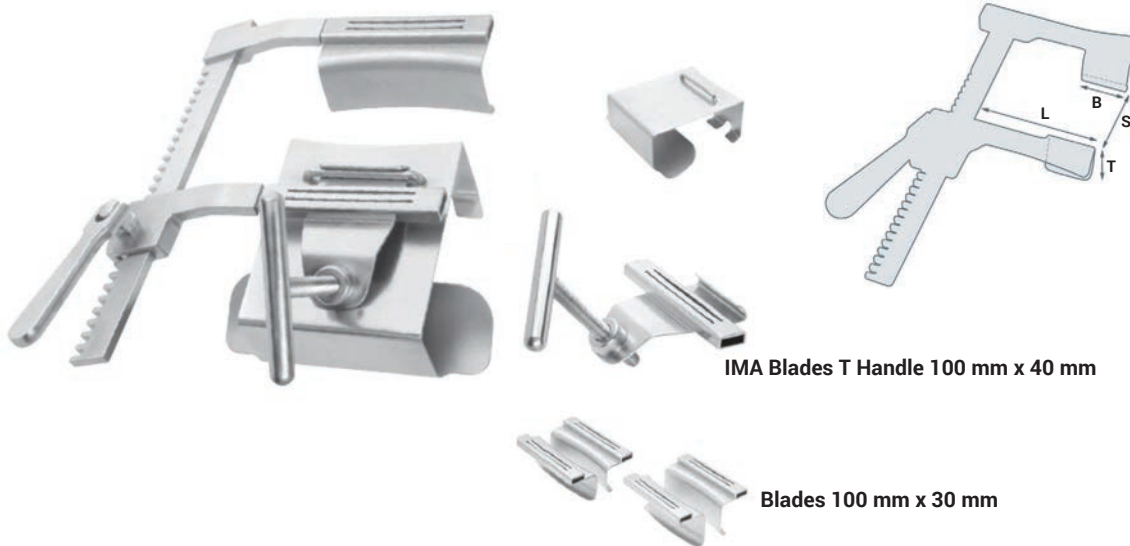

IMA Blades T Handle 100 mm x 40 mm

Blades 100 mm x 30 mm

T	B	L	S
50 mm	100 mm	140 mm	160 mm

DuBost Retractor

**Code**

DA-1259-00

## IMA Cardiovascular Retractor Stainless Steel

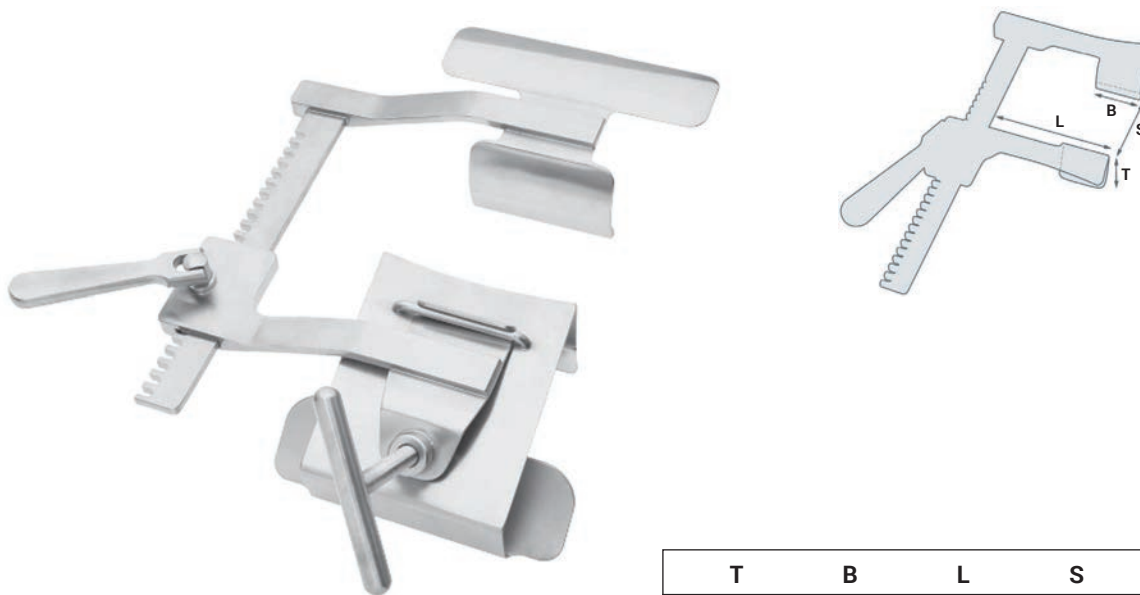

T	B	L	S
50 mm	150 mm	195 mm	134 mm

IMA Retractor

**Code**

DA-1260-00

IMA Cardiovascular Retractor Swivel Blades Stainless Steel



- 2 x Cooley Small Blades 25 mm
- 1 x Cooley Medium Blades 40 mm
- 1 x Cooley Large Blades 50 mm
- 2 x Malleable Ribbon Blades

IMA Retractor Complete set

Code

DA-1261-00

CARDIOVASCULAR RETRACTOR

# CARDIOVASCULAR RETRACTOR

## Cardibase Retractor System

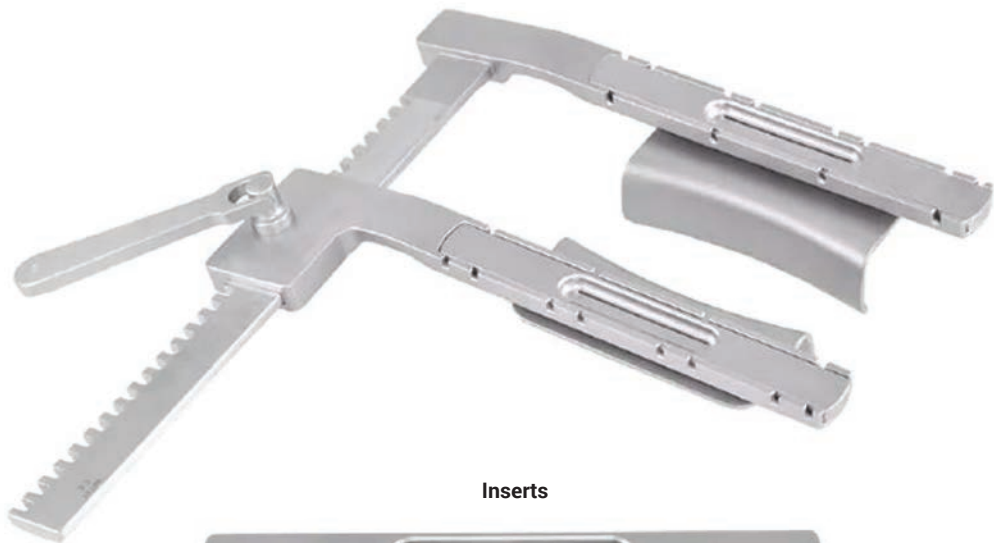
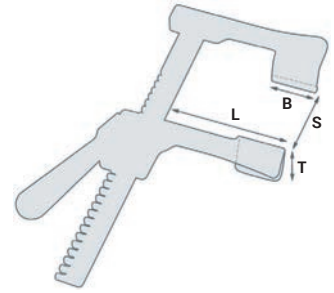

Inserts



Cooley Blades 30 mm x 100 mm

**Description**

Cardibase Retractor Frame with 2 Inserts and  
2 x Cooley Blades 30 mm x 100 mm x 190 mm x 190 mm

**Code**

CB1-10-9325-12

### Snap in Coupling for attachments



**Description**

Snap in Coupling for attachments

**Code**

CB1-10-9325-10

### Morse Blades

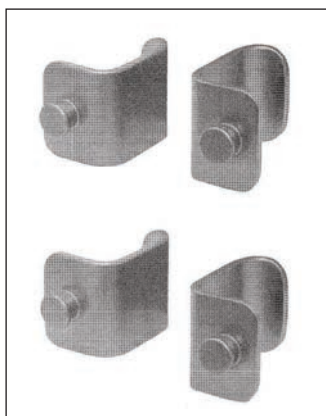

**Description**

4 x Morse Blades 30 mm x 28 mm

4 x Morse Blades 40 mm x 28 mm

**Code**

CB1-10-9325-30M

CB1-10-9325-40M

### Cooley Blades

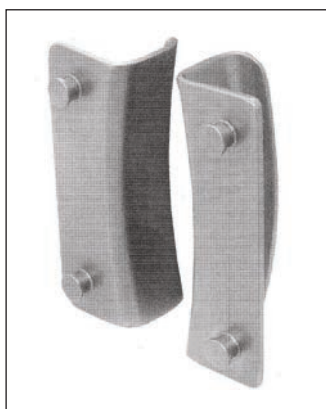

**Description**

2 x Cooley Blades 30 mm x 100 mm

2 x Cooley Blades 40 mm x 100 mm

**Code**

CB1-10-9325-30C

CB1-10-9325-40C

## Malleable Hooks



Cooley

Malleable  
Hook ShortMalleable  
Hook LongMalleable  
Hook Curved

Description	Dimension	Code
Cooley Malleable Rake Hook	20 mm	CB1-10-9325-20
Cooley Malleable Rake Hook	35 mm	CB1-10-9325-35
Cooley Malleable Rake Hook	45 mm	CB1-10-9325-45
Malleable Hook Short 14 cm	18 x 52 mm	CB1-10-9325-18S
Malleable Hook Short 14 cm	18 x 80 mm	CB1-10-9325-19S
Malleable Hook Short 14 cm	22 x 80 mm	CB1-10-9325-20S
Malleable Hook Long 19 cm	18 x 52 mm	CB1-10-9325-21S
Malleable Hook Long 19 cm	18 x 80 mm	CB1-10-9325-22S
Malleable Hook Long 19 cm	22 x 80 mm	CB1-10-9325-23S
Malleable Hook Long Curved 19 cm	18 x 52 mm	CB1-10-9325-24S
Malleable Hook Long Curved 19 cm	18 x 80 mm	CB1-10-9325-25S
Malleable Hook Long Curved 19 cm	22 x 80 mm	CB1-10-9325-26S

### Ross Retractor Serrated Cardiobase Retractor

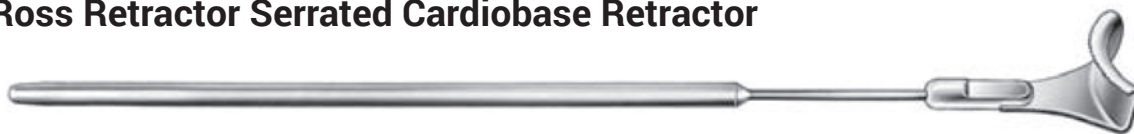

Description	Dimension	Code
Ross Retractor serrated, 25 cm, Small	16 x 16 mm	CB1-10-9325-60
Ross Retractor serrated, 25 cm, Medium	24 x 14 mm	CB1-10-9325-61
Ross Retractor serrated, 25 cm, Large	24 x 17 mm	CB1-10-9325-62

### Marberger Retractor Cardiobase Retractor



Description	Dimension	Code
Marberger Retractor, 24 cm, Small	17 mm	CB1-10-9325-63
Marberger Retractor, 24 cm, Medium	20 mm	CB1-10-9325-64
Marberger Retractor, 24 cm, Large	23 mm	CB1-10-9325-65

### Cooley-type Rake Retractor Malleable Cardiobase Retractor



Description	Dimension	Code
Cooley-type Rake Retractor Malleable 26 cm, Small	20 mm	CB1-10-9325-66
Cooley-type Rake Retractor Malleable 26 cm, Medium	35 mm	CB1-10-9325-67
Cooley-type Rake Retractor Malleable 26 cm, Large	45 mm	CB1-10-9325-68



CARDIOVASCULAR RETRACTOR

**Cooley-type Rake Retractor Rigid Cardiobase Retractor****Description**

Cooley-type Rake Retractor Rigid, 24 cm, Small  
 Cooley-type Rake Retractor Rigid, 24 cm, Medium  
 Cooley-type Rake Retractor Rigid, 24 cm, Tricuspid  
 Cooley-type Rake Retractor Rigid, 24 cm, Large

**Dimension**

20 mm  
 35 mm  
 45 mm  
 45 mm

**Code**

CB1-10-708-20  
 CB1-10-708-35  
 CB1-10-708-45  
 CB1-10-708-45\*

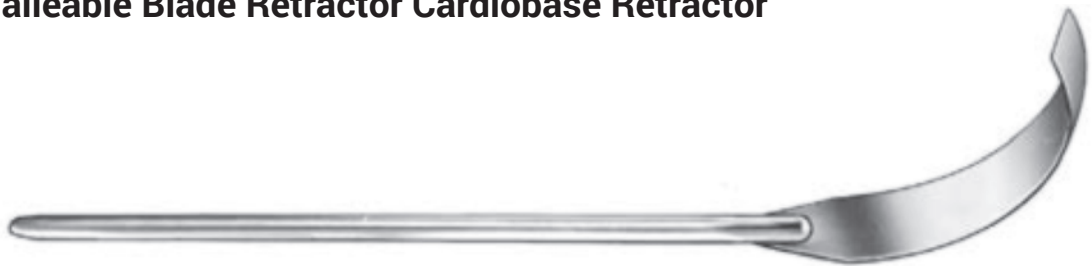
**Malleable Blade Retractor Cardiobase Retractor****Description**

Malleable Blade Retractor, 26 cm

**Code**

CB1-10-708-24

**Malleable Illumination Arm Cardiobase Retractor****Description**

Fits onto almost all available Rib Spreaders

**Code**

CB1-10-708-00

## Removable Blades IMA Retractor System

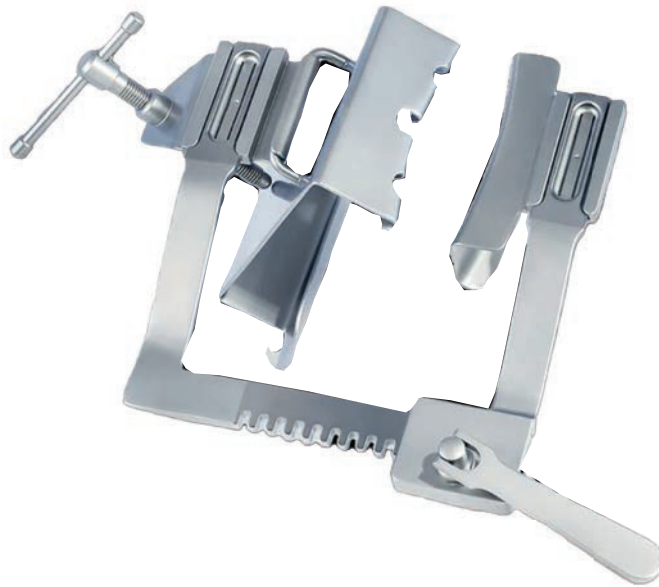

Blades

IMA Blades Long Screw Connection



### Description

- Retractor 40 mm x 100 mm x 230 mm x 160 mm
- Retractor 50 mm x 60 mm x 230 mm x 160 mm
- Set Blades 30 mm x 100 mm
- Set Blades 50 mm x 100 mm
- Set Blades 60 mm x 100 mm
- Set Blades 35 mm x 42 mm
- IMA Blade Long Screw Connection
- IMA Blade Short with Teeth

### Code

- CB1-10-5430-01
- CB1-10-5430-02
- CB1-10-5430-03/30
- CB1-10-5430-04/50
- CB1-10-5430-04/60
- CB1-10-5430-05
- CB1-10-5430-06
- CB1-10-5430-07

## Cooley Mitral Retractor System



Description	Spreading width	Arm length	Code
Cooley Mitral Frame, XXL	205 mm	230 mm	CB1-10-708-42
Side Arm Bar, Blades Retractor attachment, diam: 6 mm			CB1-10-708-45
Main Clamp Blades Retractor attachment, diam: 6 mm			CB1-10-708-50

Description	Width	Depth	Code
Cooley Blades Small, Curved	28 mm	35 mm	CB1-10-709-05
Cooley Blades Medium, Curved	38 mm	35 mm	CB1-10-709-15
Cooley Blades Flat	42 mm	22 mm	CB1-10-709-20

**Cooley Mitral Retractor System**



Description	Spreading width	Arm length	Code
Cooley Mitral Frame XL	180 mm	180 mm	CB1-10-708-41

Description	Width	Depth	Code
Cooley Atrial Retractor Blades, Small	25 mm	35 mm	CB1-10-708-60*
Cooley Atrial Retractor Blades	40 mm	35 mm	CB1-10-708-65*
Cooley Atrial Retractor Blades, Large	50 mm	35 mm	CB1-10-708-70*
Cooley Atrial Retractor Blades, Tricuspid	50 mm	20 mm	CB1-10-708-75*
Atrial Retractor, Large	50 mm	35 mm	CB1-10-729-45
Atrial Retractor, Large, Low Profile	50 mm	20 mm	CB1-10-729-48
Ribbon Blades Retractor	25 mm	76 mm	CB1-10-729-50
Ribbon Blades Retractor	19 mm	76 mm	CB1-10-729-52
Ribbon Blades Retractor	13 mm	76 mm	CB1-10-729-55
Cooley Small Blades	25 mm	35 mm	CB1-10-729-35
Cooley Blades Medium, Slightly Curved	38 mm	48 mm	CB1-10-709-10
Cooley Medium Blades	38 mm	35 mm	CB1-10-729-40
Cooley Blades Small, Curved	28 mm	35 mm	CB1-10-709-25*
Cooley Blades Medium, Slightly Curved	38 mm	48 mm	CB1-10-709-30*
Cooley Blades Medium, Curved	38 mm	35 mm	CB1-10-709-35*
Cooley Blades Flat	42 mm	22 mm	CB1-10-709-40*

CARDIOVASCULAR RETRACTOR

**IMA Couetil Retractor****Description**

IMA Couetil Retractor 150 mm X 150 mm

1 x Long Blade 100 mm

2 x French Hook 40 mm x 22 mm

2 x French Hook 50 mm x 22 mm

**Code**

CB1-10-725-05

CB1-10-725-06

CB1-10-725-07

CB1-10-725-08

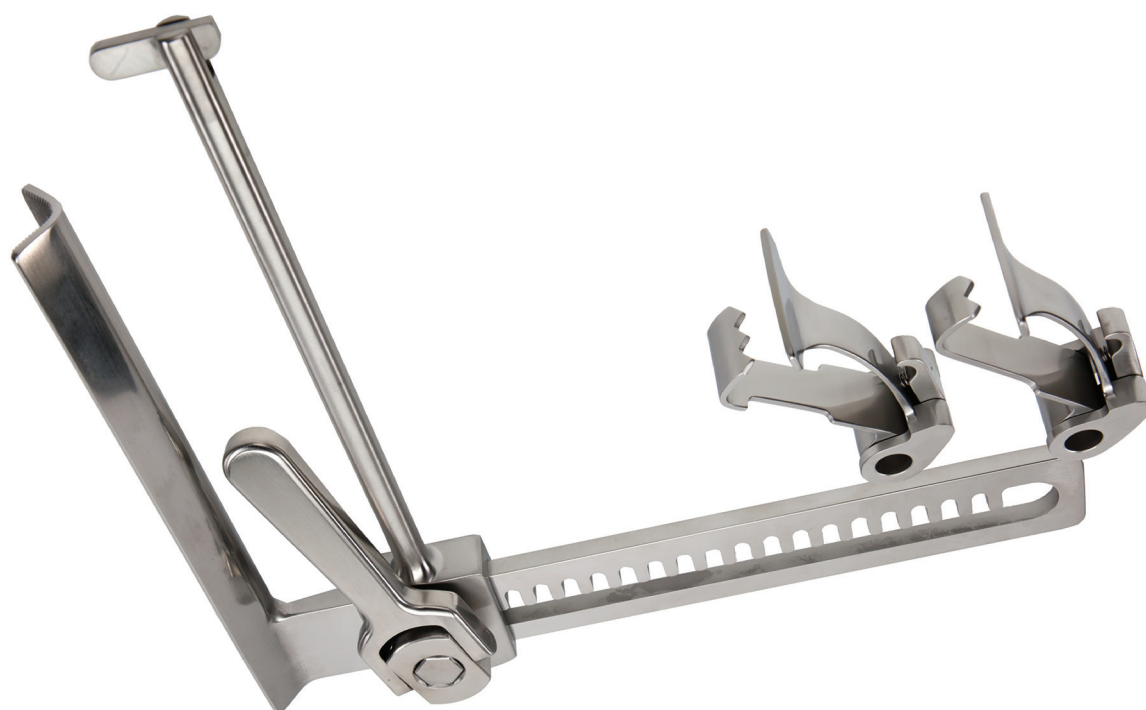

## IMA Retractor System



### Description

- 1 x Frame with Arms
- 1 x Fixation T Rack
- 1 x Fixation Blades
- 1 x T Clamps
- 2 x Universal Clamps
- 2 x Small Cooley Blades 25 mm
- 1 x Medium Cooley Blades 40 mm
- 1 x Large Cooley Blades 50 mm
- 2 x Ribbon Malleable Blades Retractor

### Code

- CB1-10-729-04
- CB1-10-729-07
- CB1-10-729-09
- CB1-10-729-15
- CB1-10-729-30
- CB1-10-729-35
- CB1-10-729-40
- CB1-10-729-50
- CB1-10-729-55

# CARDIOVASCULAR RETRACTOR

Carpentier Mitral Valve Retractors

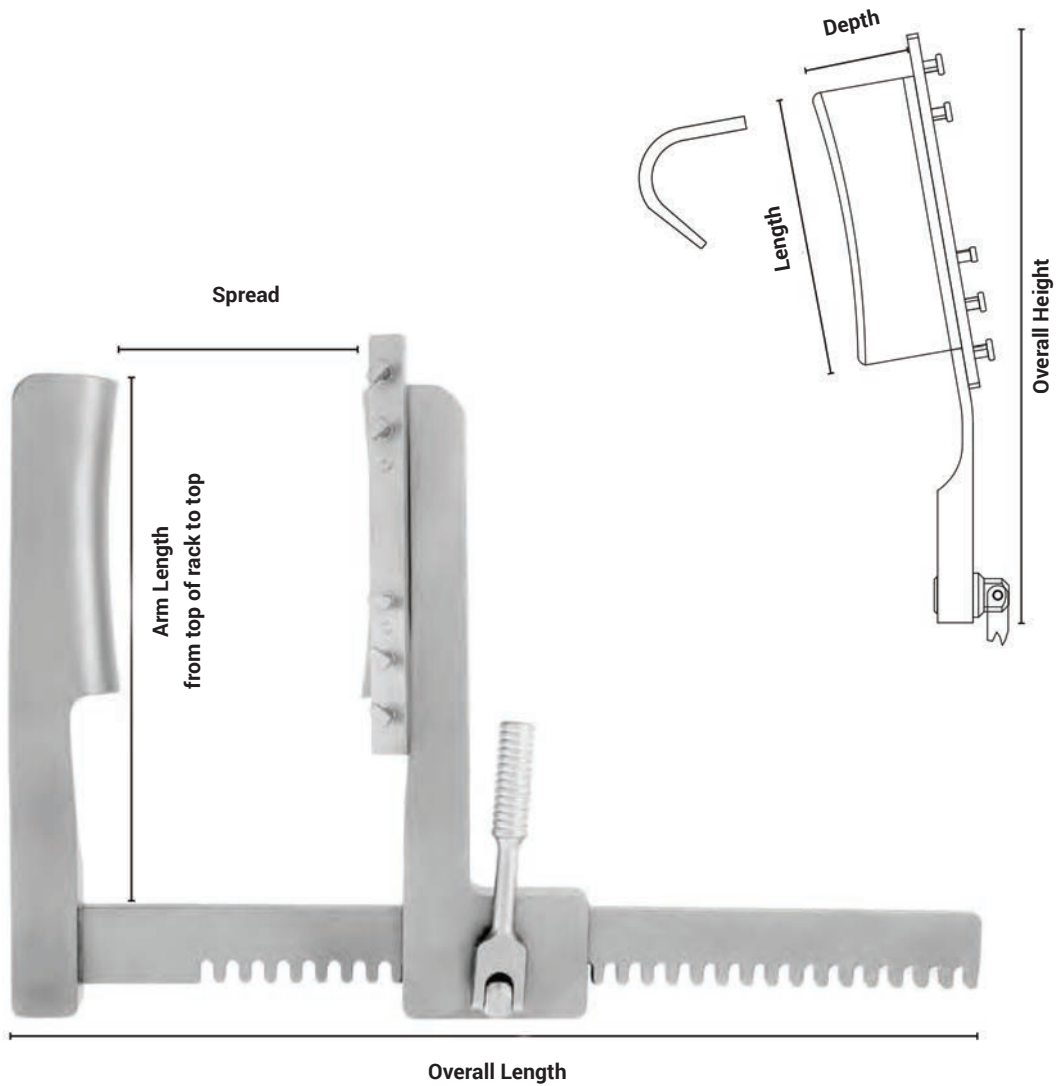

Description	Overall Length mm	Overall Length mm	Arm Length from top of rack to top mm	Blade Length mm	Blade Depth mm	Blade Width mm	Max. Spread mm	Code
Carpentier Mitral Valve Thorax Spreader	306	215	165	100	36	38	200	CB1-10-3023-00
<b>Description</b>								<b>Code</b>
Retractor Frame, 2 Sternal Blades								CB1-10-3027-00
Retractor Frame, 2 Sternal Blades								CB1-10-3028-00
<b>Description</b>								<b>Code</b>
Set								CB1-10-3023-00

Carpentier Mitral Valve Retractors

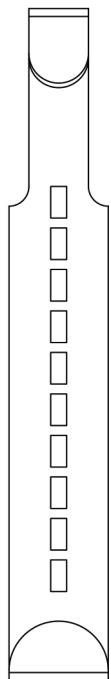

Description	Length	Code
Sternal Blades for Carpentier Thorax Spreader	15/25 mm	CB1-10-3027-00

Description	Length	Code
Sternal Blades for Carpentier Thorax Spreader	15/25 mm	CB1-10-3028 00

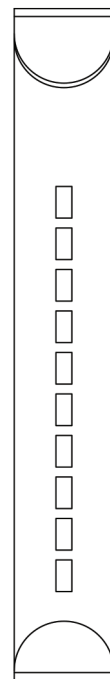

**Thorax Lifting Retractor****Description**

Thorax Lifting Retractor Stable Rib Elevation  
Plus Facilitates Harvesting, Excellent Exposure, Larger Operating Area,  
Choice of 2 Lower Blades, Choice of 3 Upper Blades

**Code**

CB1-10-1180-00

**French Model Mini IMA Retractor****Description**

Lifting Retractor, 37 mm x 12 mm x 180 mm x 150 mm

**Code**

CB1-10-1190-00

## McCarthy Mini Sternotomy Retractor System

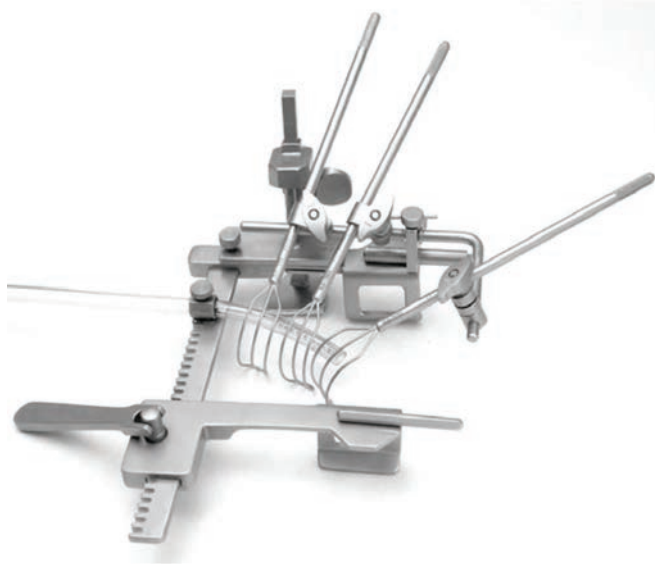

The Self-retaining Retractor was designed to provide excellent exposure for a variety of valve operations, maze procedure, or other intra cardiac procedures. It can also be used for mini sternotomy or coronary artery bypass operations or for mini sternotomy procedures depending on the patients size. The removable lift attachment allows for better exposure for valve procedures.

### Description

Chest Spreader Finochietto Dual Bars  
 Split Universal Clamp for attachments  
 Universal Clamp for attachments  
 Main Bracket

### Code

CB1-10-2935-01  
 CB1-10-2935-02  
 CB1-10-2935-03  
 CB1-10-2935-04



**Sellors Rib Spreader Stainless Steel**

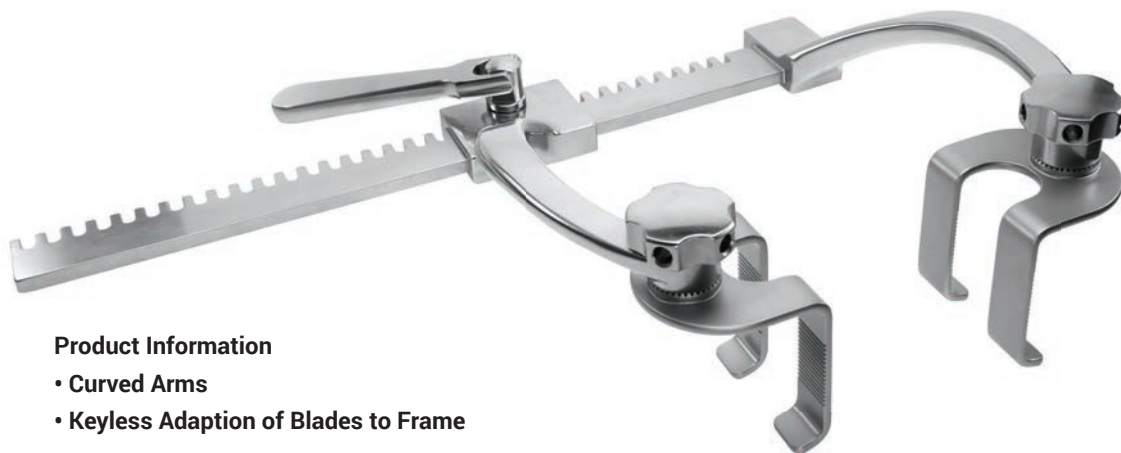

**Product Information**

- Curved Arms
- Keyless Adaption of Blades to Frame

Description	Code
Sellors Rib Spreader Stainless Steel	CB1-10-739-05

Consisting of:

Description	Spreading Width	Arm Length	Qty	Code
Sellors Frame	min. 197 mm	140 mm	1	CB1-10-739-10

Description	Width	Depth	Qty	Code
1 Pair of Blades	50 mm	40 mm	1	CB1-10-739-25
1 Pair of Blades	50 mm	50 mm	1	CB1-10-739-30
1 Pair of Blades	50 mm	70 mm	1	CB1-10-739-35

Options

Description	Width	Depth	Qty	Code
1 Pair of Blades	75 mm	30 mm	1	CB1-10-739-50
1 Pair of Blades	75 mm	45 mm	1	CB1-10-739-55
1 Pair of Blades	120 mm	30 mm	1	CB1-10-739-60
1 Pair of Blades	75 mm	78 mm	1	CB1-10-739-65

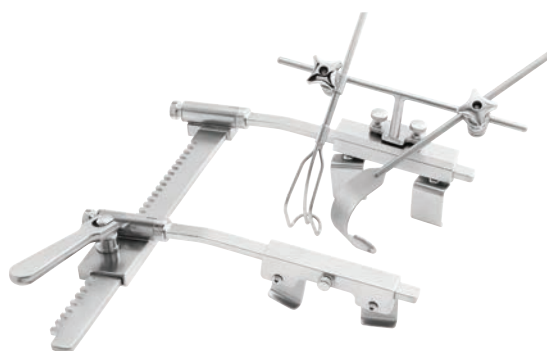

**Volkman Retractor**

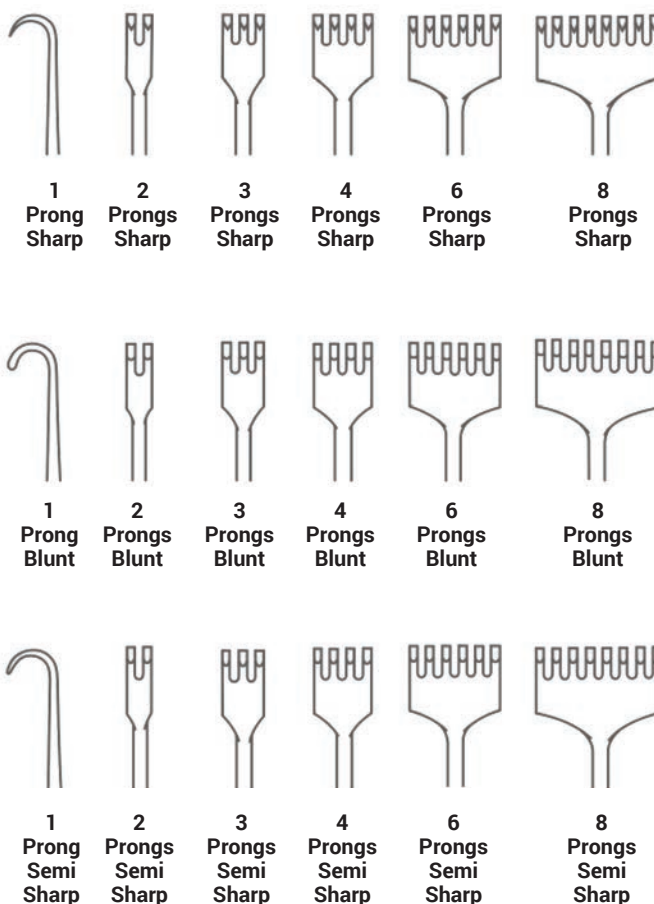

Description	Length	Code
Volkman Retractor 1 Prong Sharp	22 cm	BG-001-01
Volkman Retractor 1 Prong Semi-Sharp	22 cm	BG-001-02
Volkman Retractor 1 Prong Blunt	22 cm	BG-001-03
Volkman Retractor 2 Prongs Sharp	22 cm	BG-002-01
Volkman Retractor 2 Prongs Semi-Sharp	22 cm	BG-002-02
Volkman Retractor 2 Prongs Blunt	22 cm	BG-002-03
Volkman Retractor 3 Prongs Sharp	22 cm	BG-003-01
Volkman Retractor 3 Prongs Semi-Sharp	22 cm	BG-003-02
Volkman Retractor 3 Prongs Blunt	22 cm	BG-003-03
Volkman Retractor 4 Prongs Sharp	22 cm	BG-004-01
Volkman Retractor 4 Prongs Semi-Sharp	22 cm	BG-004-02
Volkman Retractor 4 Prongs Blunt	22 cm	BG-004-03
Volkman Retractor 5 Prongs Sharp	22 cm	BG-005-01
Volkman Retractor 5 Prongs Semi-Sharp	22 cm	BG-005-02
Volkman Retractor 5 Prongs Blunt	22 cm	BG-005-03
Volkman Retractor 6 Prongs Sharp	22 cm	BG-006-01
Volkman Retractor 6 Prongs Semi-Sharp	22 cm	BG-006-02
Volkman Retractor 6 Prongs Blunt	22 cm	BG-006-03
Volkman Retractor 8 Prongs Sharp	22 cm	BG-008-01
Volkman Retractor 8 Prongs Semi-Sharp	22 cm	BG-008-02
Volkman Retractor 8 Prongs Blunt	22 cm	BG-008-03

**Volkman Retractor**

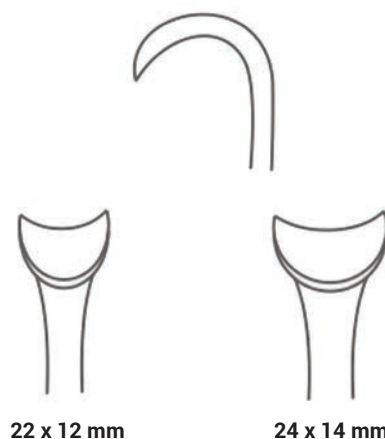

**Description**

Volkman Retractor 22 x 12 mm  
 Volkman Retractor 24 x 14 mm

**Length**

22 cm  
 22 cm

**Code**

BG-009-01  
 BG-009-02



**Volkman Retractor**



42 x 10 mm



42 x 15 mm



24 x 14 mm

**Description**

Volkman Retractor 42 x 10mm

**Length**

22 cm

**Code**

BG-009-03

Volkman Retractor 42 x 15mm

22 cm

BG-009-04

Volkman Retractor 43 x 20mm

22 cm

BG-009-05

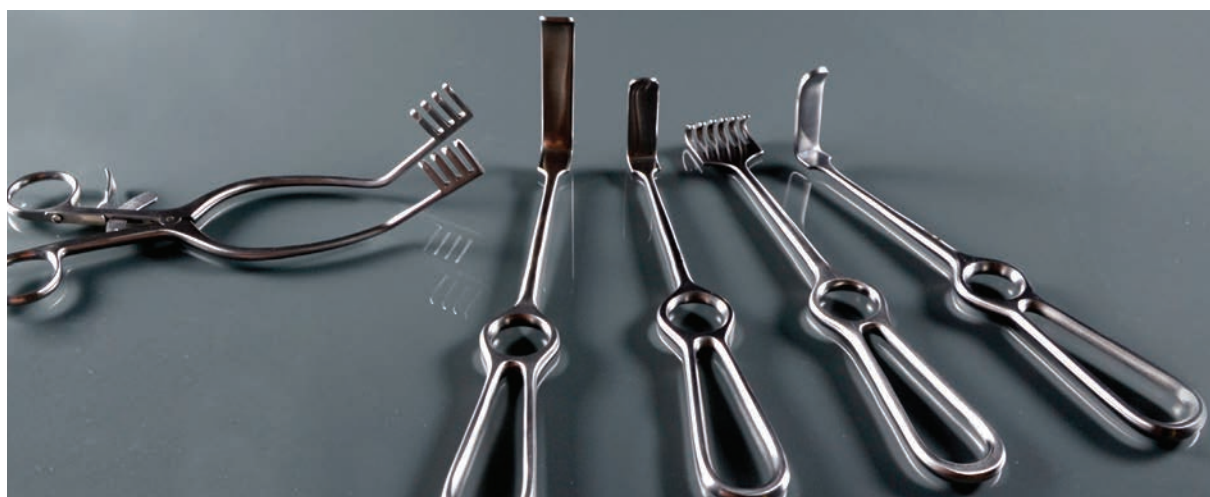

**CARDIOVASCULAR RETRACTOR**

## Koerte Retractor

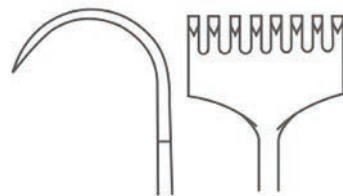

Sharp 8 Prongs

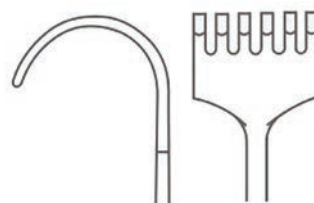

Blunt 6 Prongs

**Description**

Koerte Retractor 8 Prongs Sharp

Koerte Retractor 6 Prongs Blunt

**Length**

24 cm

24 cm

**Code**

BG-011-24

BG-012-24

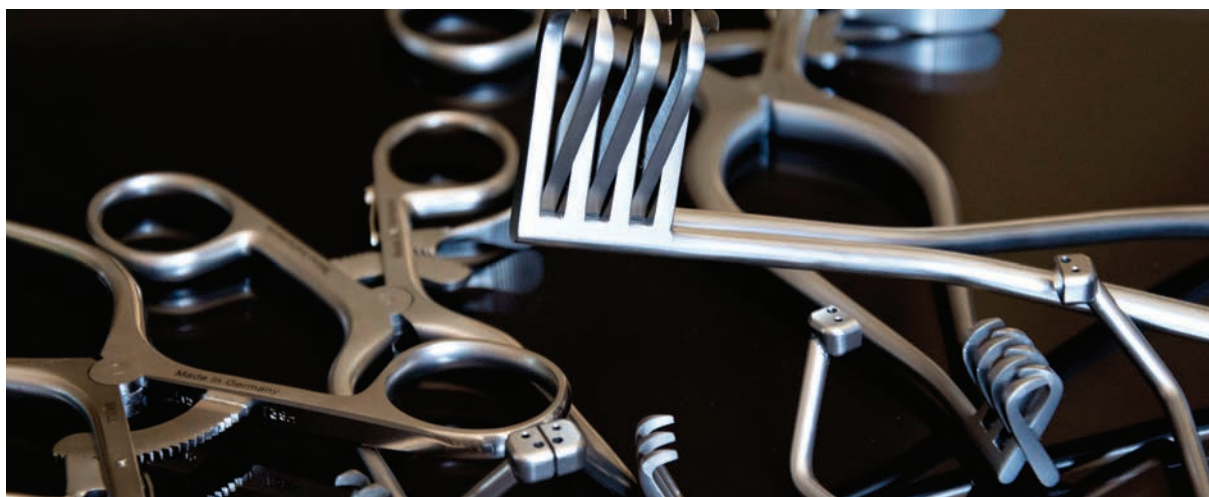

Israel Retractor



Blunt 4 Prongs  
Blunt 5 Prongs  
Blunt 6 Prongs  
Blunt 7 Prongs

Description	Length	Code
Israel Retractor 4 Prongs Blunt	25 cm	BG-012-25
Israel Retractor 5 Prongs Blunt	25 cm	BG-013-25
Israel Retractor 6 Prongs Blunt	25 cm	BG-014-25
Israel Retractor 7 Prongs Blunt	25 cm	BG-015-25

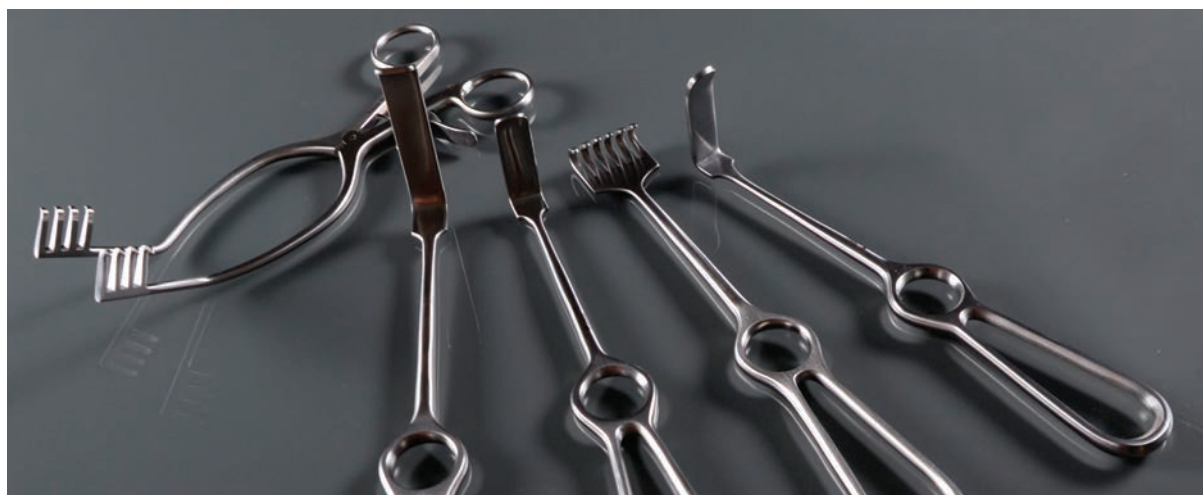

CARDIOVASCULAR RETRACTOR

## Kocher Langenbeck Retractor

**Description**

Kocher Langenbeck 81 x 45 mm

**Length**

21 cm

**Code**

BG-025-11

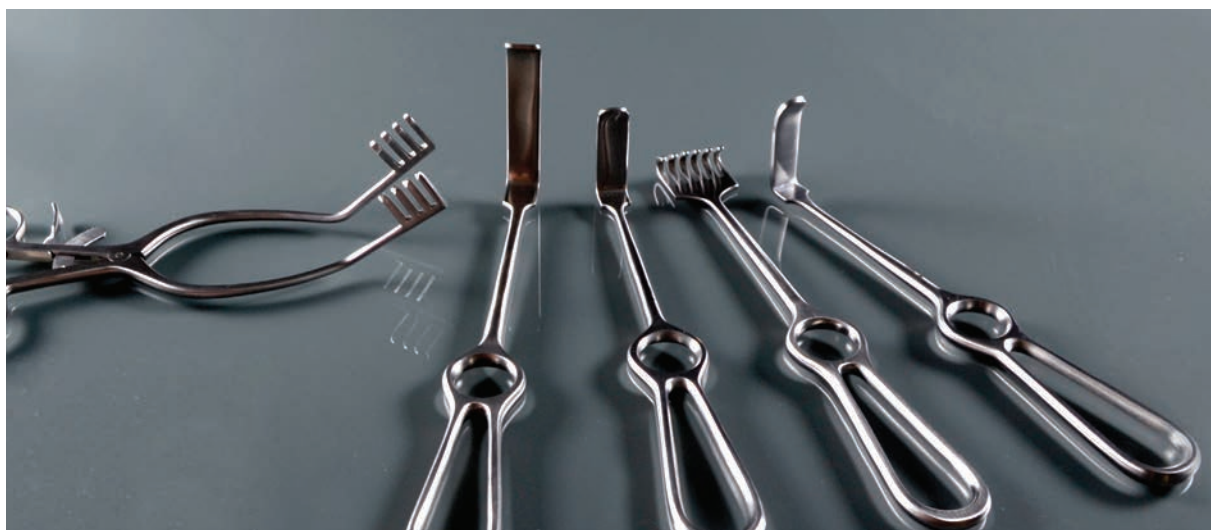

### Jefferson Retractor

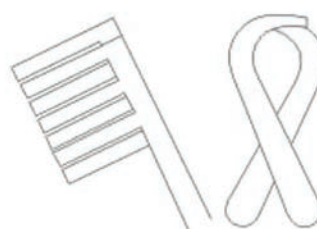

2 x 3 Blunt Prongs

Description	Length	Code
Jefferson Retractor 2 x 3 Teeth Blunt	13 cm	BG-023-13

### Valve Retractor



Description	Length	Code
Valve Retractor Titanium Handle 5 mm	18 cm	BG-170-01
Valve Retractor Titanium Handle 7 mm	18 cm	BG-170-02
Valve Retractor Titanium Handle 9 mm	18 cm	BG-170-03
Valve Retractor Titanium Handle 10 mm	18 cm	BG-170-04
Valve Retractor Titanium Handle 11 mm	18 cm	BG-170-05
Valve Retractor Titanium Handle 13 mm	18 cm	BG-170-06
Valve Retractor Titanium Handle 15 mm	18 cm	BG-170-07

# CARDIOVASCULAR RETRACTOR

## Desmarres Open Lid Retractor



12 mm



14 mm



16 mm



18 mm

**Description**

Desmarres Open Lid Retractor 12 mm  
 Desmarres Open Lid Retractor 14 mm  
 Desmarres Open Lid Retractor 16 mm  
 Desmarres Open Lid Retractor 18 mm

**Length**

16 cm  
 16 cm  
 16 cm  
 16 cm

**Code**

BG-139-01  
 BG-139-02  
 BG-139-03  
 BG-139-04



**Desmarres Lid Retractor**

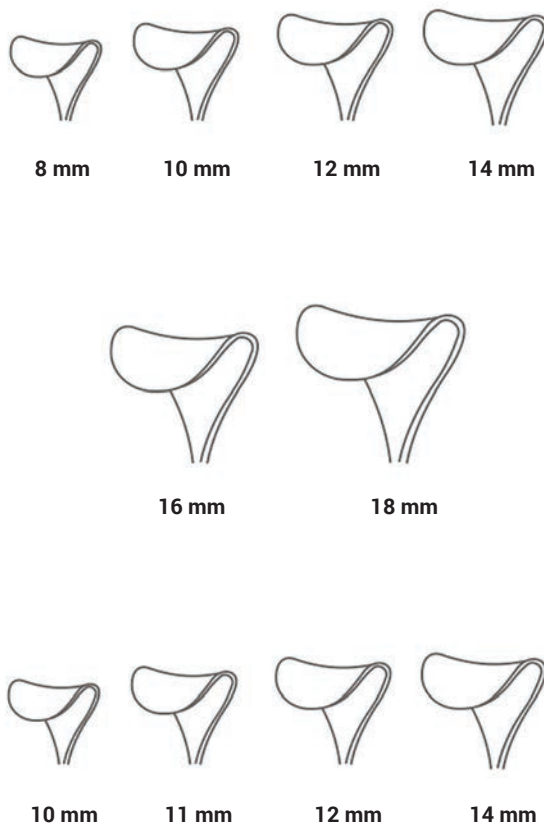

**CARDIOVASCULAR RETRACTOR**

**Description**

**Length**

**Code**

Desmarres Lid Retractor 8 mm	16 cm	BG-138-01
Desmarres Lid Retractor 10 mm	16 cm	BG-138-02
Desmarres Lid Retractor 12 mm	16 cm	BG-138-03
Desmarres Lid Retractor 14 mm	16 cm	BG-138-04
Desmarres Lid Retractor 16 mm	16 cm	BG-138-05
Desmarres Lid Retractor 18 mm	16 cm	BG-138-06
Desmarres Solid Blade Lid Retractor 10 mm	16 cm	BG-140-07S
Desmarres Solid Blade Lid Retractor 11 mm	16 cm	BG-140-08S
Desmarres Solid Blade Lid Retractor 12 mm	16 cm	BG-140-09S
Desmarres Solid Blade Lid Retractor 14 mm	16 cm	BG-140-10S

Ross Retractor

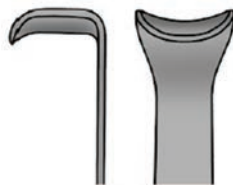

Fig. 1

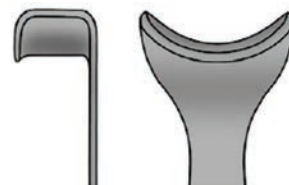

Fig. 2

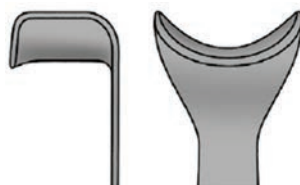

Fig. 3

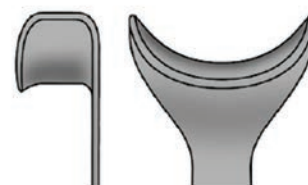

Fig. 4

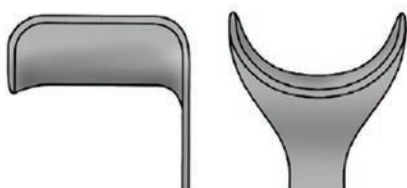

Fig. 5

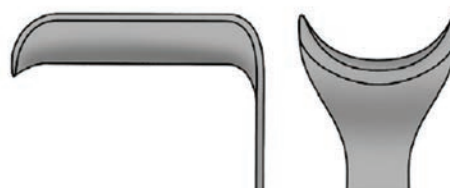

Fig. 6

**Description**

- Ross Retractor 16 x 15 mm
- Ross Retractor 23 x 13 mm
- Ross Retractor 25 x 18 mm
- Ross Retractor 29 x 13 mm
- Ross Retractor 29 x 29 mm
- Ross Retractor 21 x 35 mm

**Length**

- 26 cm
- 26 cm
- 26 cm
- 26 cm
- 26 cm
- 26 cm

**Code**

- BG-325-01
- BG-325-02
- BG-325-03
- BG-325-04
- BG-325-05
- BG-325-06



**Cooley Atrium Retractor With Serrated Teeth****Description**

Cooley Atrium Retractor With Serrated Teeth 25 mm x 35 mm Right  
 Cooley Atrium Retractor With Serrated Teeth 40 mm x 35 mm Right  
 Cooley Atrium Retractor With Serrated Teeth 50 mm x 35 mm Right  
 Cooley Atrium Retractor With Serrated Teeth 50 mm x 10 mm Left

**Length**

21 cm  
 21 cm  
 21 cm  
 21 cm

**Code**

DA-1300-01  
 DA-1300-02  
 DA-1300-03  
 DA-1300-04

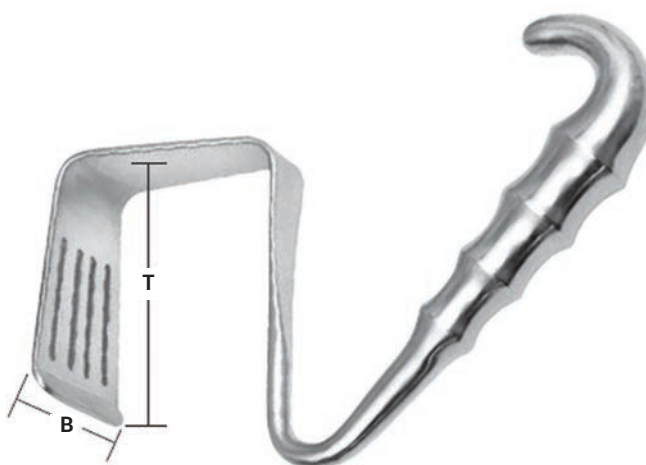
**Davidson Scapula Retractor****Description**

Davidson Scapula Retractor 50 mm x 75 mm  
 Davidson Scapula Retractor 90 mm x 75 mm

**Length**

20 cm  
 20 cm

**Code**

DA-1305-01  
 DA-1305-02

### Copper Retractor Malleable



Description	Length	Code
Copper Retractor Malleable 4 mm	20 cm	BG-074-01
Copper Retractor Malleable 7 mm	20 cm	BG-074-02
Copper Retractor Malleable 10 mm	20 cm	BG-074-03
Copper Retractor Malleable 12 mm	20 cm	BG-074-04
Copper Retractor Malleable 15 mm	20 cm	BG-074-05
Copper Retractor Malleable 18 mm	20 cm	BG-074-06
Copper Retractor Malleable 20 mm	20 cm	BG-074-07
Copper Retractor Malleable 26 mm	20 cm	BG-074-08
Copper Retractor Malleable 30 mm	20 cm	BG-074-09
Copper Retractor Malleable 40 mm	20 cm	BG-074-10
Copper Retractor Malleable 50 mm	20 cm	BG-074-11

Description	Length	Code
Copper Retractor Malleable 4 mm	30 cm	BG-074-12
Copper Retractor Malleable 7 mm	30 cm	BG-074-13
Copper Retractor Malleable 10 mm	30 cm	BG-074-14
Copper Retractor Malleable 12 mm	30 cm	BG-074-15
Copper Retractor Malleable 15 mm	30 cm	BG-074-16
Copper Retractor Malleable 18 mm	30 cm	BG-074-17
Copper Retractor Malleable 20 mm	30 cm	BG-074-18
Copper Retractor Malleable 26 mm	30 cm	BG-074-19
Copper Retractor Malleable 30 mm	30 cm	BG-074-20
Copper Retractor Malleable 40 mm	30 cm	BG-074-21
Copper Retractor Malleable 50 mm	30 cm	BG-074-22



CARDIOVASCULAR RETRACTOR

**Cushing Lid Retractor**

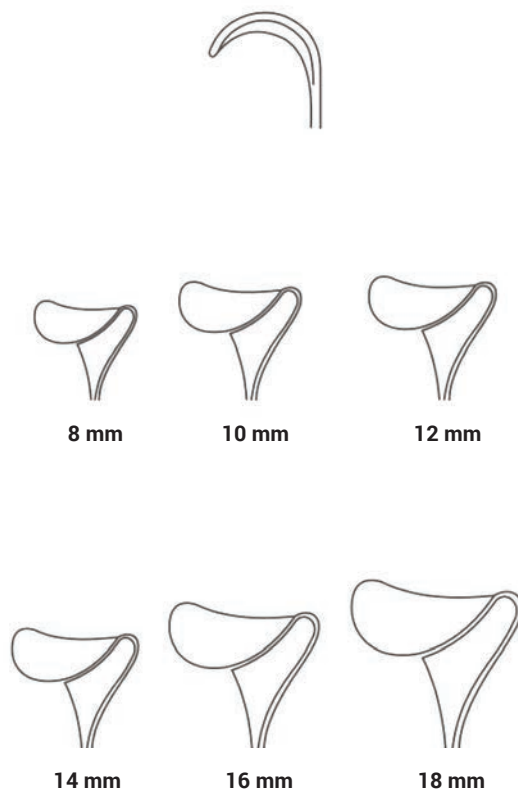

**Description**

Cushing Lid Retractor 8 mm  
 Cushing Lid Retractor 10 mm  
 Cushing Lid Retractor 12 mm  
 Cushing Lid Retractor 14 mm  
 Cushing Lid Retractor 16 mm  
 Cushing Lid Retractor 18 mm

**Length**

24 cm  
 24 cm  
 24 cm  
 24 cm  
 24 cm  
 24 cm

**Code**

BG-146-01  
 BG-146-02  
 BG-146-03  
 BG-146-04  
 BG-146-05  
 BG-146-06



**Kirklin Lid Retractor**

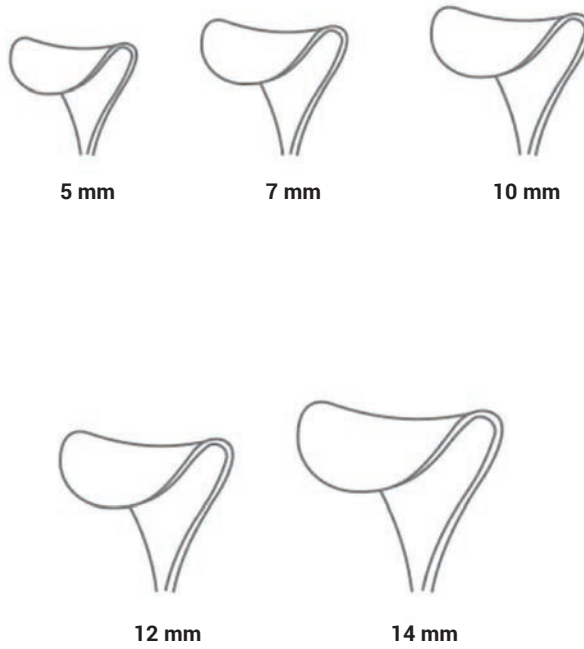

**CARDIOVASCULAR RETRACTOR**

**Description**

Kirklin Lid Retractor 5 mm  
 Kirklin Lid Retractor 7 mm  
 Kirklin Lid Retractor 10 mm  
 Kirklin Lid Retractor 12 mm  
 Kirklin Lid Retractor 14 mm

**Length**

14 cm  
 14 cm  
 14 cm  
 14 cm  
 14 cm

**Code**

BG-181-01  
 BG-181-02  
 BG-181-03  
 BG-181-04  
 BG-181-05

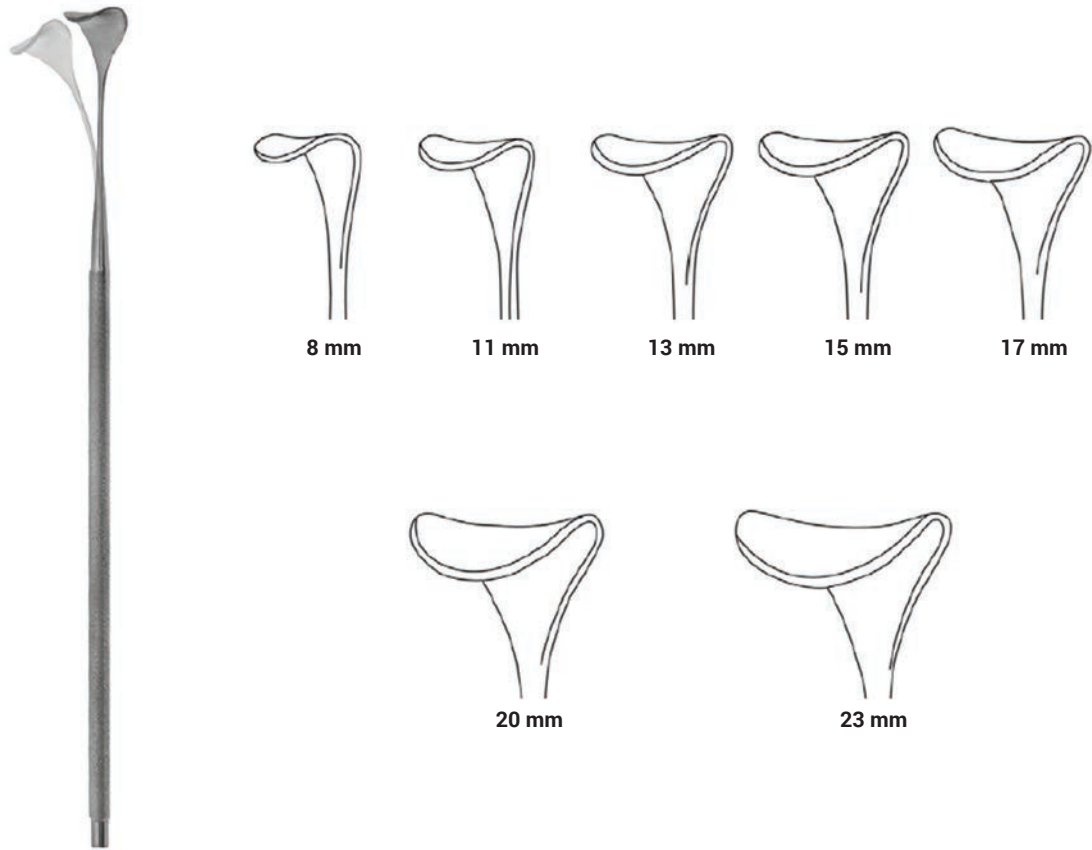

## Gill-Vernet Malleable Retractor

**Description**

Gill-Vernet Malleable Retractor 4 mm  
 Gill-Vernet Malleable Retractor 6 mm  
 Gill-Vernet Malleable Retractor 8 mm  
 Gill-Vernet Malleable Retractor 11 mm  
 Gill-Vernet Malleable Retractor 13 mm  
 Gill-Vernet Malleable Retractor 15 mm  
 Gill-Vernet Malleable Retractor 17 mm  
 Gill-Vernet Malleable Retractor 20 mm  
 Gill-Vernet Malleable Retractor 23 mm

**Length**

24 cm  
 24 cm  
 24 cm  
 24 cm  
 24 cm  
 24 cm  
 24 cm  
 24 cm  
 24 cm

**Code**

BG-148-01  
 BG-148-02  
 BG-148-03  
 BG-148-04  
 BG-148-05  
 BG-148-06  
 BG-148-07  
 BG-148-08  
 BG-148-09



**Murphy Retractor**

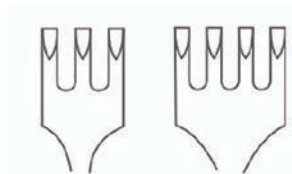

**Sharp  
3 Prongs**

**Sharp  
4 Prongs**

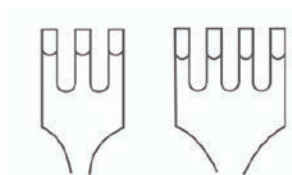

**Blunt  
3 Prongs**

**Blunt  
4 Prongs**

**Description**

- Murphy Retractor Sharp 3 Prongs
- Murphy Retractor Sharp 4 Prongs
- Murphy Retractor Blunt 3 Prongs
- Murphy Retractor Blunt 4 Prongs

**Length**

- 16 cm
- 16 cm
- 16 cm
- 16 cm

**Code**

- BG-149-01
- BG-149-02
- BG-149-03
- BG-149-04



**CARDIOVASCULAR RETRACTOR**

## Senn Miller Double Ended Retractor

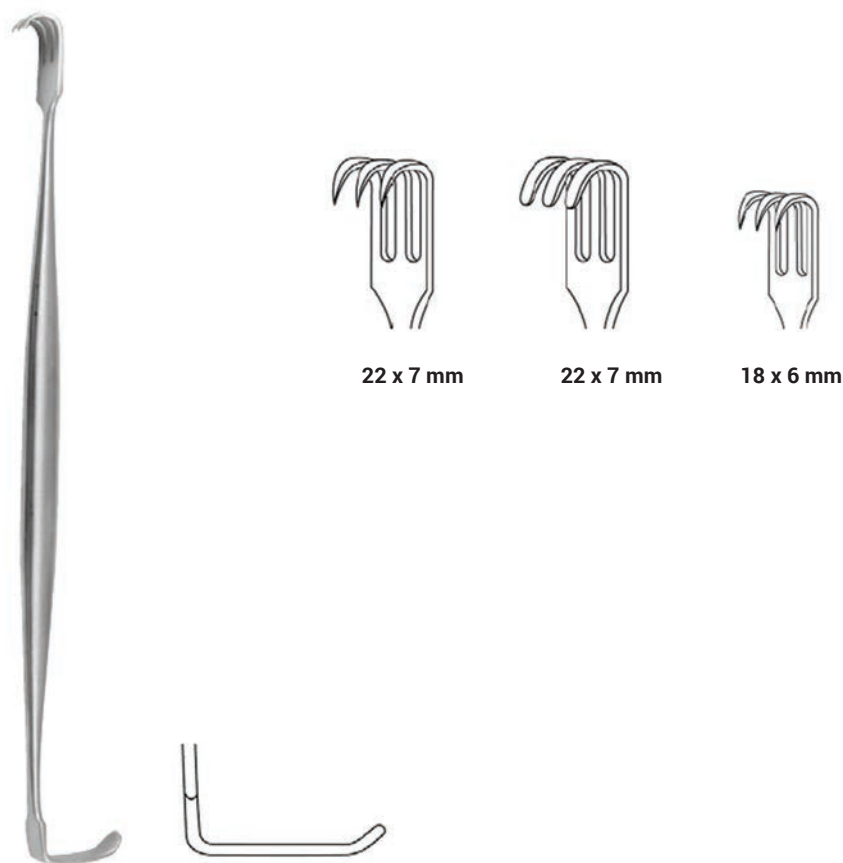
**Description**

Senn Miller Double Ended Retractor Sharp  
 Senn Miller Double Ended Retractor Blunt  
 Senn Miller Double Ended Retractor Sharp

**Length**

16 cm  
 16 cm  
 15 cm

**Code**

BG-150-01  
 BG-150-02  
 BG-150-03

## Czerny Double Ended Retractor

**Description**

Czerny Double Ended Retractor

**Length**

20 cm

**Code**

BG-063-18

**Kocher Langenbeck Retractor**

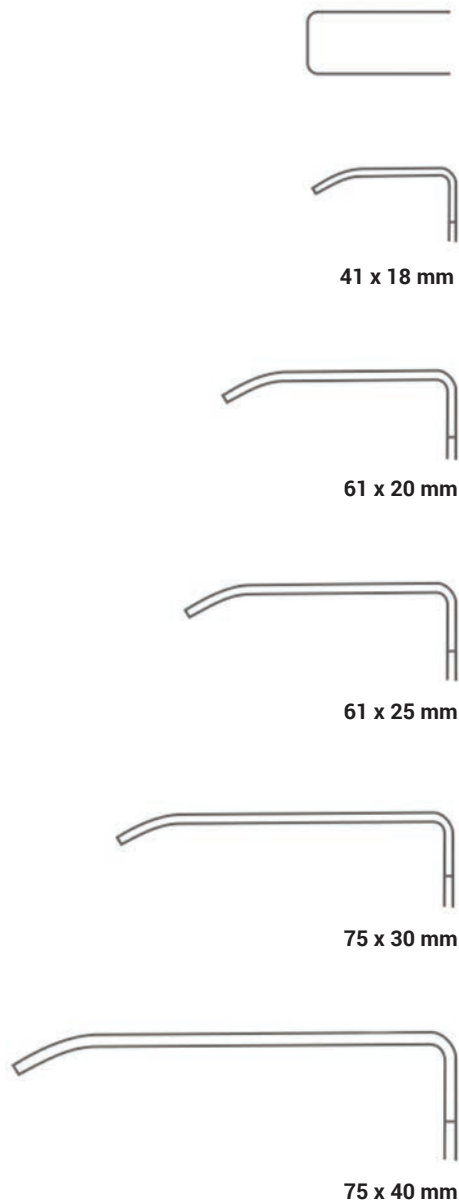

**CARDIOVASCULAR RETRACTOR**

**Description**

Kocher Langenbeck Retractor 41x18 mm  
 Kocher Langenbeck Retractor 61x20 mm  
 Kocher Langenbeck Retractor 61x25 mm  
 Kocher Langenbeck Retractor 75x30 mm  
 Kocher Langenbeck Retractor 75x40 mm

**Length**

21 cm  
 21 cm  
 21 cm  
 21 cm  
 21 cm

**Code**

BG-025-05  
 BG-025-06  
 BG-025-07  
 BG-025-08  
 BG-025-09

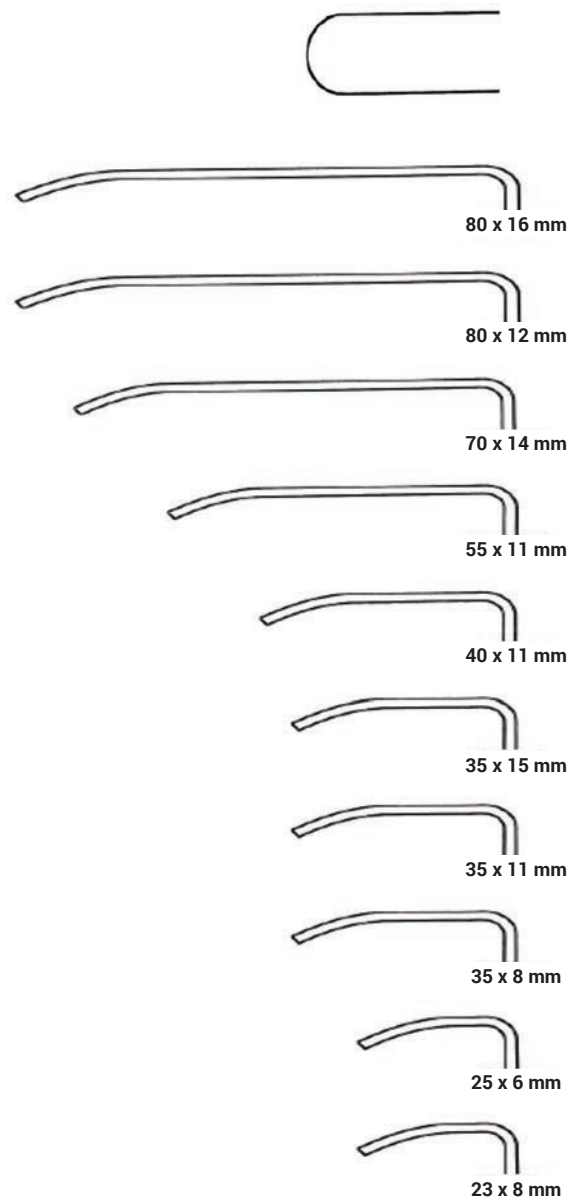

## Kocher-Langenbeck Retractor

**Description**

Kocher-Langenbeck Retractor 23 x 8 mm  
 Kocher-Langenbeck Retractor 25 x 6 mm  
 Kocher-Langenbeck Retractor 35 x 8 mm  
 Kocher-Langenbeck Retractor 35 x 11 mm  
 Kocher-Langenbeck Retractor 35 x 15 mm  
 Kocher-Langenbeck Retractor 40 x 11 mm  
 Kocher-Langenbeck Retractor 55 x 11 mm  
 Kocher-Langenbeck Retractor 70 x 14 mm  
 Kocher-Langenbeck Retractor 80 x 12 mm  
 Kocher-Langenbeck Retractor 80 x 16 mm

**Length**

21 cm  
 21 cm  
 21 cm  
 21 cm  
 21 cm  
 21 cm  
 21 cm  
 21 cm  
 21 cm  
 21 cm

**Code**

BG-025-00  
 BG-025-01  
 BG-025-02  
 BG-025-03  
 BG-025-04  
 BG-025-05  
 BG-025-06  
 BG-025-07  
 BG-025-08  
 BG-025-09

## Kocher-Langenbeck Retractor

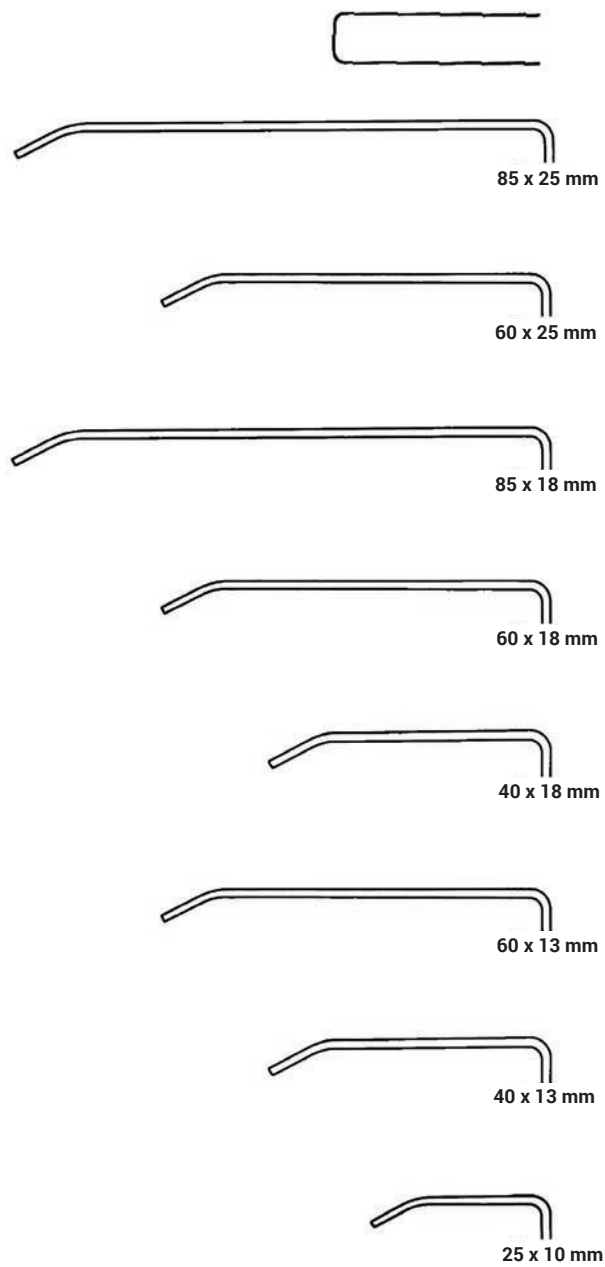
**Description**

Kocher-Langenbeck Retractor 25 x 10 mm  
 Kocher-Langenbeck Retractor 40 x 13 mm  
 Kocher-Langenbeck Retractor 60 x 13 mm  
 Kocher-Langenbeck Retractor 40 x 18 mm  
 Kocher-Langenbeck Retractor 60 x 18 mm  
 Kocher-Langenbeck Retractor 85 x 18 mm  
 Kocher-Langenbeck Retractor 60 x 25 mm  
 Kocher-Langenbeck Retractor 85 x 25 mm

**Length**

21 cm  
 21 cm  
 21 cm  
 21 cm  
 21 cm  
 21 cm  
 21 cm  
 21 cm

**Code**

BG-025-11  
 BG-025-12  
 BG-025-13  
 BG-025-14  
 BG-025-15  
 BG-025-16  
 BG-025-17  
 BG-025-18

**Ross Retractor Serrated**

Description	Dimension	Code
Ross Retractor Serrated, 25 cm, Small	16 x 16 mm	CB1-10-9325-60
Ross Retractor Serrated, 25 cm, Medium	24 x 14 mm	CB1-10-9325-61
Ross Retractor Serrated, 25 cm, Large	24 x 17 mm	CB1-10-9325-62

**Marberger Retractor**

Description	Dimension	Code
Marberger Retractor, 24 cm, Small	17 mm	CB1-10-9325-63
Marberger Retractor, 24 cm, Medium	20 mm	CB1-10-9325-64
Marberger Retractor, 24 cm, Large	23 mm	CB1-10-9325-65

**Cooley-type Rake Retractor Malleable**

Description	Dimension	Code
Cooley-type Rake Retractor Malleable 26 cm, Small	20 mm	CB1-10-9325-66
Cooley-type Rake Retractor Malleable 26 cm, Medium	35 mm	CB1-10-9325-67
Cooley-type Rake Retractor Malleable 26 cm, Large	45 mm	CB1-10-9325-68



Harrington Cardio Retractors

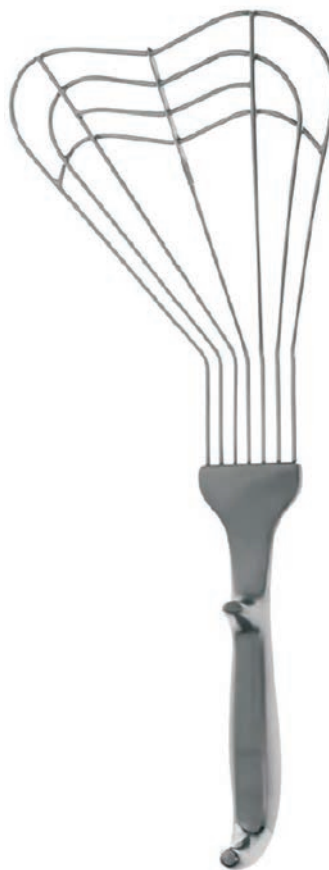
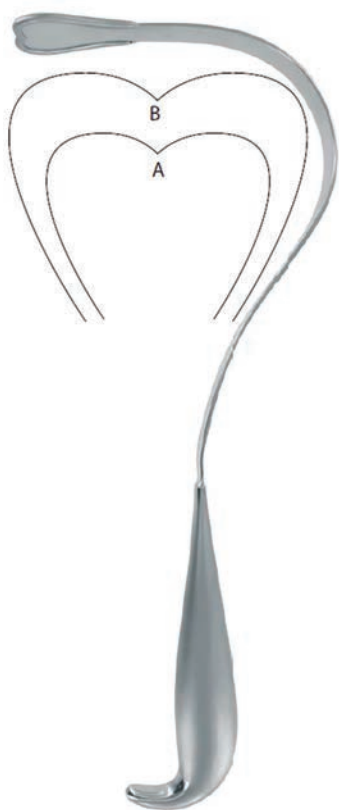

**Description**  
Harrington Steel  
Handle

40 mm

**Code**  
DA-1500-01

32 cm

**Code**  
DA-1500-02

**Description**  
Harrington Silicone  
Handle

40 mm

**Code**  
DA-1500-03

32 cm

**Code**  
DA-1500-04

**Description**  
Harrington Steel  
Handle

40 mm

**Code**  
DA-1500-05

32 cm



CARDIOVASCULAR RETRACTOR

# CARDIOVASCULAR RETRACTOR

**Deaver Retractor**



**DuBost Hand Retractor**

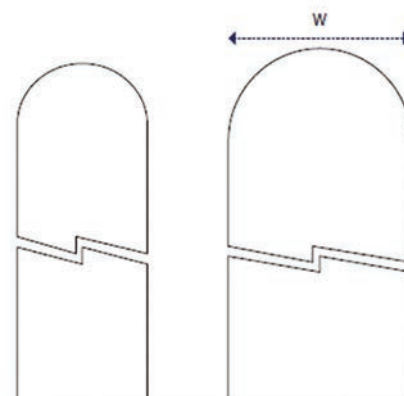

**Length**  
255 mm

**Depth**  
28 mm

**Length**  
255 mm

**Depth**  
35 mm

**Description**  
Deaver Retractor

Length 30 cm  
Depth 25 mm

**Code**  
DA-1501-01

Length 30 cm  
Depth 38 mm

**Code**  
DA-1501-02

Length 30 cm  
Depth 50 mm

**Code**  
DA-1501-03

Length 30 cm  
Depth 55 mm

**Code**  
DA-1501-04



**Description**  
DuBost Hand Retractor

Length 26 cm  
Depth 28 mm

**Code**  
DA-1503-01

Length 26 cm  
Depth 35 mm

**Code**  
DA-1503-02

Allison Hand Retractor



**Description**  
Allison Hand  
Retractor

Length 25 cm

**Code**  
DA-1505-01



**Description**  
Allison Hand  
Retractor

Length 30 cm

**Code**  
DA-1505-02



CARDIOVASCULAR RETRACTOR

**Memory (Nitinol) Retractor Malleable**

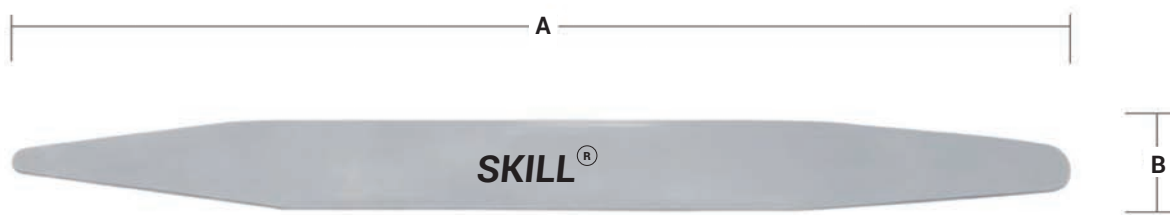

Description	Length	Code
Memory (Nitinol) Retractor Malleable 10 mm	20 cm	BG-075-01
Memory (Nitinol) Retractor Malleable 15 mm	20 cm	BG-075-02
Memory (Nitinol) Retractor Malleable 20 mm	20 cm	BG-075-03

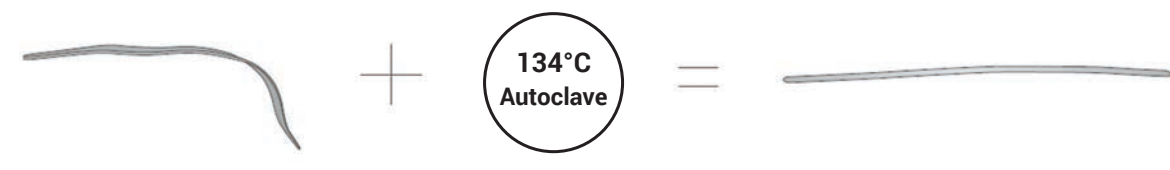

**Epicardial Retractor 3x3 Teeth**



Description	Code
Epicardial Retractor 3x3 Teeth Blunt 25 mm	DA-1400-01
Epicardial Retractor 3x3 Teeth Blunt 31 mm	DA-1400-02
Epicardial Retractor 3x3 Teeth Blunt 38 mm	DA-1400-03
Epicardial Retractor 3x3 Teeth Blunt 54 mm	DA-1400-04
Epicardial Retractor 3x3 Teeth Sharp 25 mm	DA-1401-01
Epicardial Retractor 3x3 Teeth Sharp 31 mm	DA-1401-02
Epicardial Retractor 3x3 Teeth Sharp 38 mm	DA-1401-03
Epicardial Retractor 3x3 Teeth Sharp 54 mm	DA-1401-04

**Alm Retractor**



Description	Length	Code
Alm Retractor Blunt	7 cm	BG-007-07
Alm Retractor Blunt	10 cm	BG-007-10
Alm Retractor Sharp	7 cm	BG-008-07
Alm Retractor Sharp	10 cm	BG-008-10

**Weitlander Retractor**



Description	Length	Code
Weitlander Retractor Blunt 2x3 Teeth	11 cm	BG-217-11
Weitlander Retractor Blunt 3x4 Teeth	13 cm	BG-217-13
Weitlander Retractor Blunt 3x4 Teeth	16 cm	BG-217-16
Weitlander Retractor Blunt 3x4 Teeth	20 cm	BG-217-20
Weitlander Retractor Blunt 3x4 Teeth	25 cm	BG-217-25
Weitlander Retractor Semi Sharp 3x4 Teeth	11 cm	BG-218-11
Weitlander Retractor Semi Sharp 3x4 Teeth	13 cm	BG-218-13
Weitlander Retractor Semi Sharp 3x4 Teeth	16 cm	BG-218-16
Weitlander Retractor Semi Sharp 3x4 Teeth	20 cm	BG-218-20
Weitlander Retractor Semi Sharp 3x4 Teeth	25 cm	BG-218-25
Weitlander Retractor Sharp 2x3 Teeth	11 cm	BG-219-11
Weitlander Retractor Sharp 3x4 Teeth	13 cm	BG-219-13
Weitlander Retractor Sharp 3x4 Teeth	16 cm	BG-219-16
Weitlander Retractor Sharp 3x4 Teeth	20 cm	BG-219-20
Weitlander Retractor Sharp 3x4 Teeth	25 cm	BG-219-25



Anderson Adson Retractor



4 x 4  
Sharp  
Prongs



4 x 4  
Blunt  
Prongs

**Description**

Anderson Adson Retractor 4 x 4 Teeth Sharp

Anderson Adson Retractor 4 x 4 Teeth Blunt

**Length**

20 cm

20 cm

**Code**

BG-240-20

BG-241-20



**Travers Retractor**



**4 x 4  
Blunt  
Prongs**

**Description**

Travers Retractor 4 x d5 Teeth Blunt

**Length**

21 cm

**Code**

BG-247-21

**Ionescu Handheld Valve Retractor**



**Description**

Ionescu Handheld Valve Retractor Double Ended 6 mm/7 mm

**Length**

21 cm

**Code**

BG-9801-01

## Ionescu Handheld Valve Retractor

**Description**

Ionescu Handheld Valve Retractor 1.2 mm/1.7 mm

Ionescu Handheld Valve Retractor 2.2 mm/2.5 mm

**Length**

18 cm

23 cm

**Code**

BG-9801-02

BG-9801-03



## SKILL Atraumatic Retraction System

Complete System Code: CB1-10-600-00

### PRODUCT INFORMATION

#### ARS - The Atraumatic Retraction System for Sternotomies

- Universal and modular system.
- To be used with various atrial retractor blades and additional accessories (e.g. snake arm)
- Integrated suture holders for fixation and organisation of sutures (up to 10 sutures) during operations with and without heart-lung machine.
- Design of the system allows maximum possible exposition of OR field.
- OR-table fixation arm.

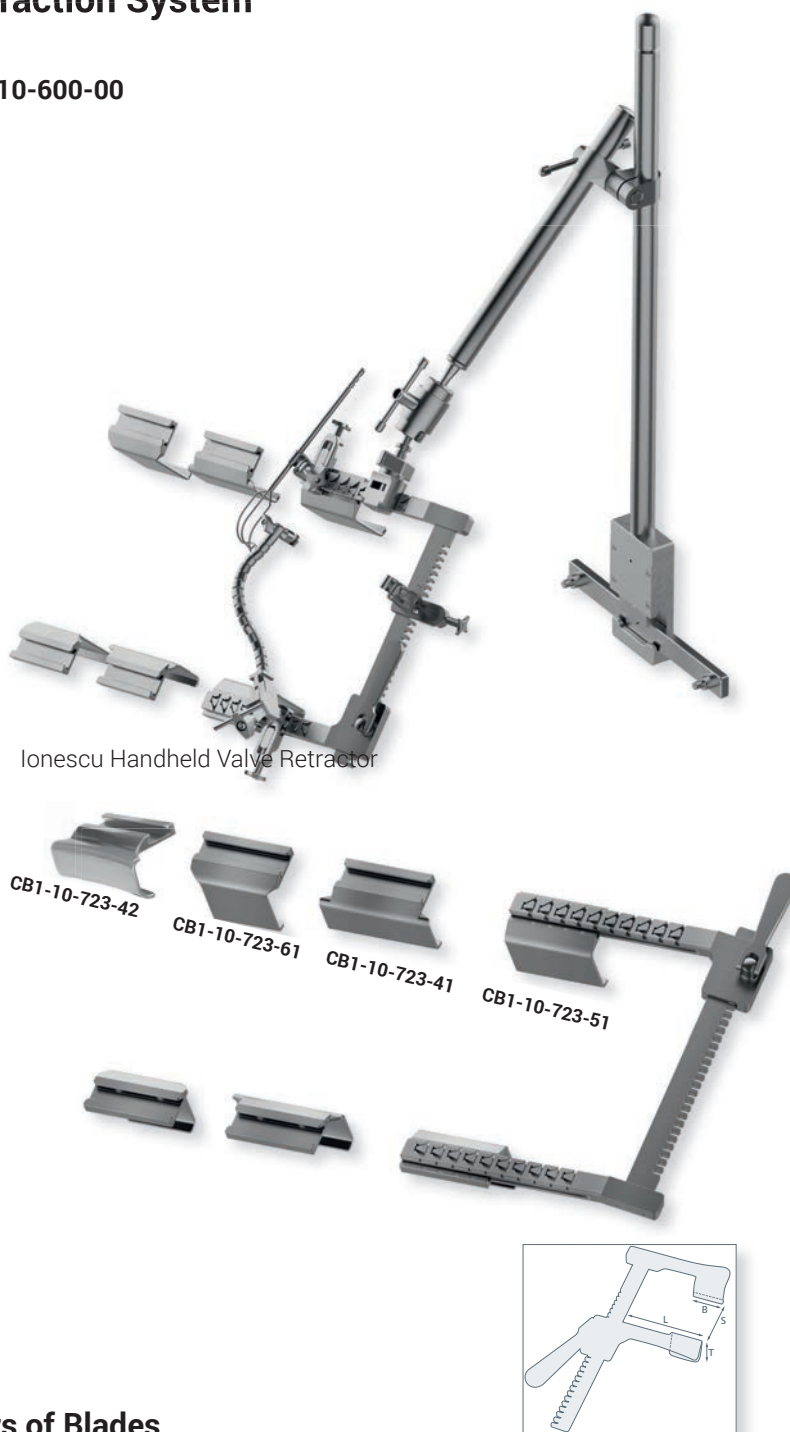

Ionescu Handheld Valve Retractor

CB1-10-723-42

CB1-10-723-61

CB1-10-723-41





CB1-10-723-51

#### ARS-Spreader with 4 pairs of Blades

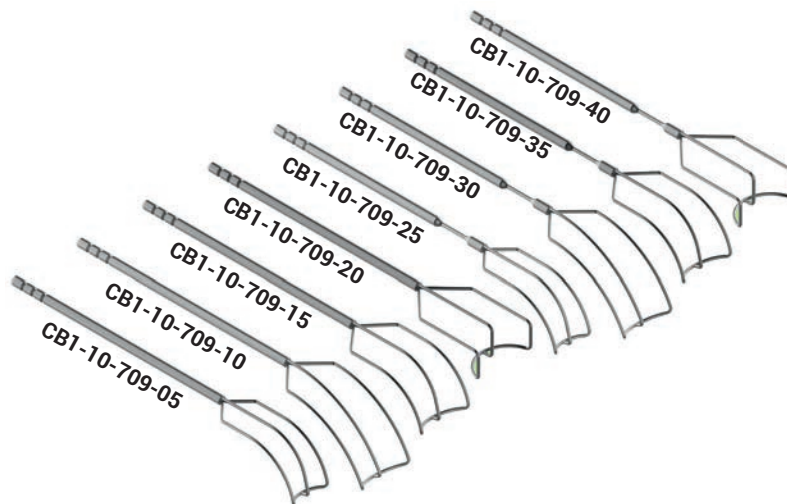
Item Description	Description	Spreading width (S)	Arm length (L)
CB1-10-600-05	ARS-Spreader with suture holders	245 mm	193 mm
<b>Inclusive</b>		Width (B)	Depth (T)
CB1-10-723-51	Pair of blades	80 mm	50 mm
CB1-10-723-41	Pair of blades	100 mm	40 mm
CB1-10-723-61	Pair of blades	60 mm	60 mm
CB1-10-723-42	Pair of blades curved	100 mm	100 mm

**SKILL Cooley Atrial Blades, Shaft Diameter, 6 mm**



Item number	Width	Length	Malleable
CB1-10-709-05	28 mm	35 mm	
CB1-10-709-10	38 mm	48 mm	
CB1-10-709-15	38 mm	35 mm	
CB1-10-709-20	42 mm	22 mm	
CB1-10-709-25	28 mm	35 mm	
CB1-10-709-30	38 mm	48 mm	
CB1-10-709-35	38 mm	35 mm	
CB1-10-709-40	42 mm	22 mm	



**Flexible Arm (type Leyla)**  
Length 185 mm

CB1-10-600-25

**Clamp for fixation of  
Blades/Retractors**  
(e.g. Colley blades) diameter 6 mm



CB1-10-600-20

**Clamp for Leyla arm for  
use with ARS-spreader**



CB1-10-600-22

**Fixation arm for  
adaption of  
ARS-spreader  
to OR-table**



CB1-10-600-30

MIDCAB Retractor System Complete

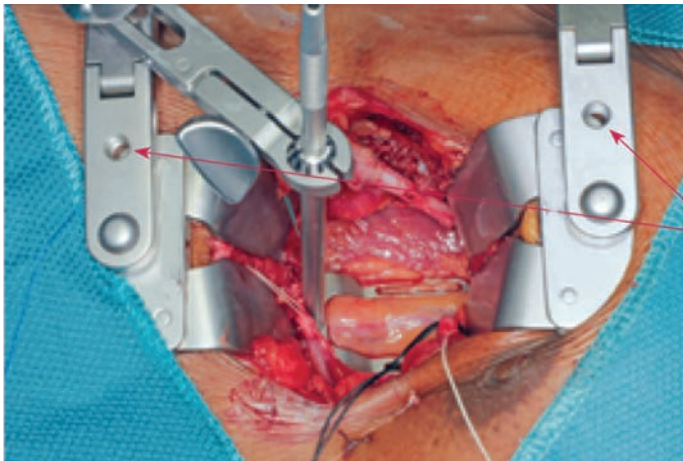

Fixation points

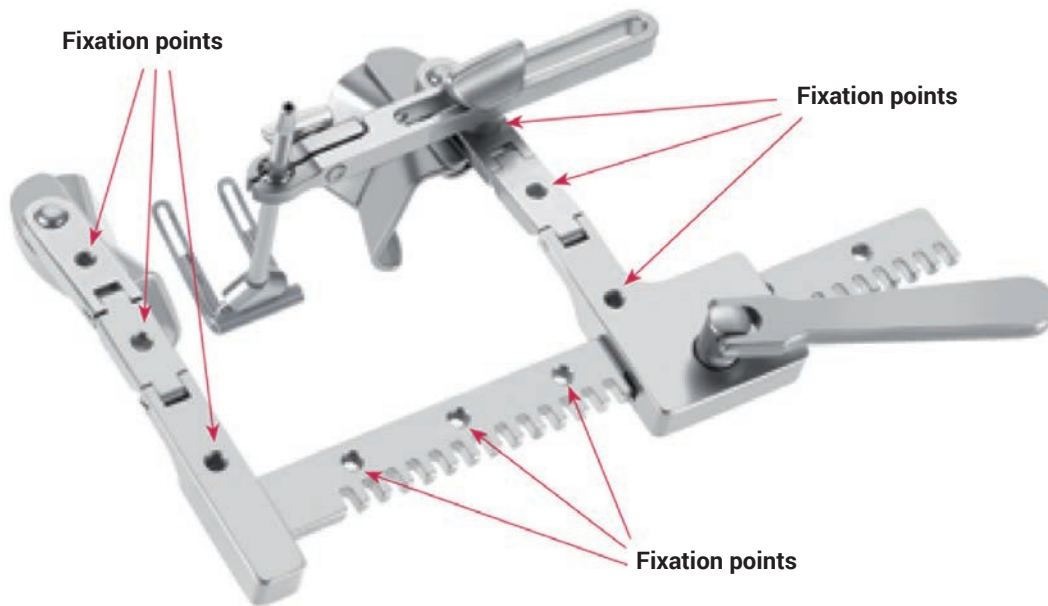

Fixation points

Fixation points

Fixation points

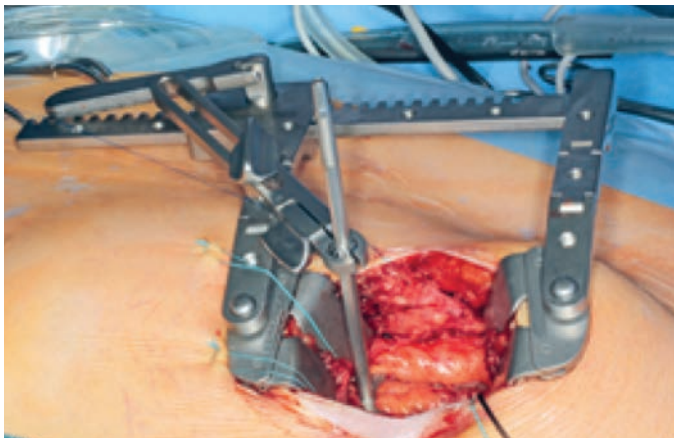

MIDCAB Retractor System Complete Blades and Stabilizer

CB1-10-9890-00

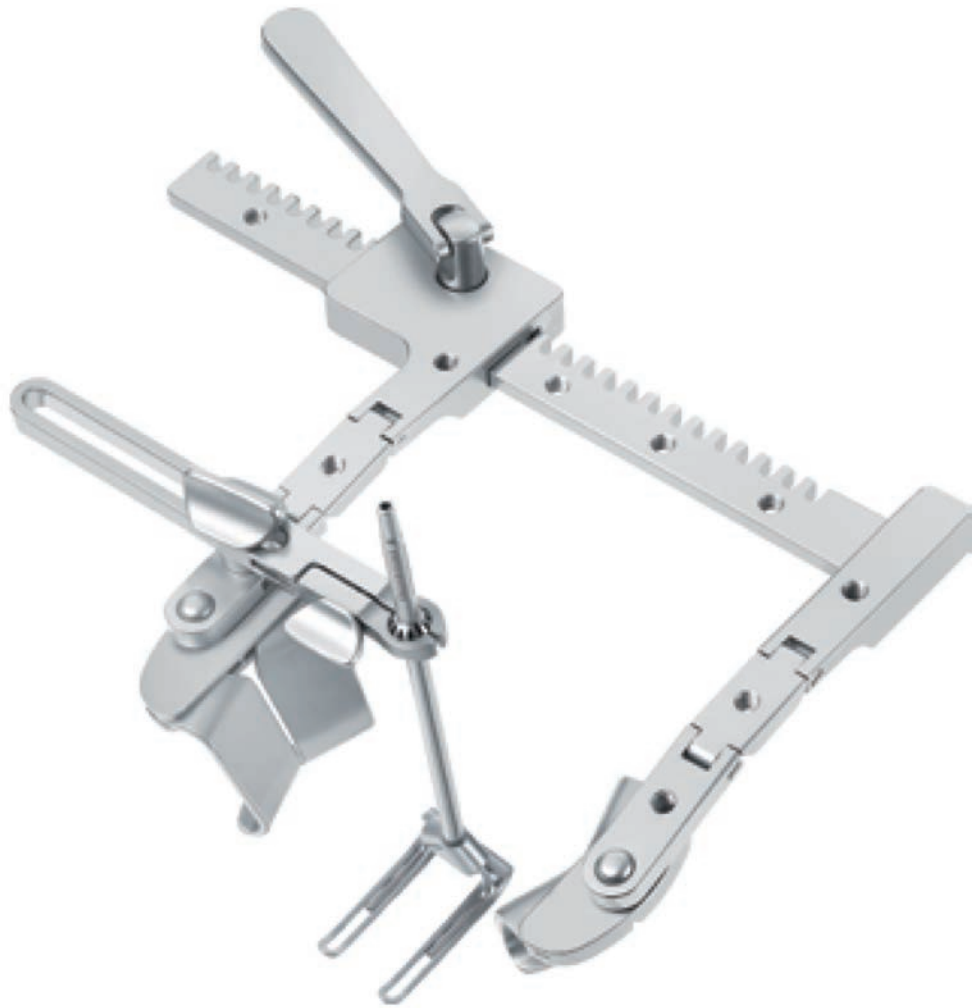

**MIDCAB Retractor Only Double Joint**

CB1-10-9890-02

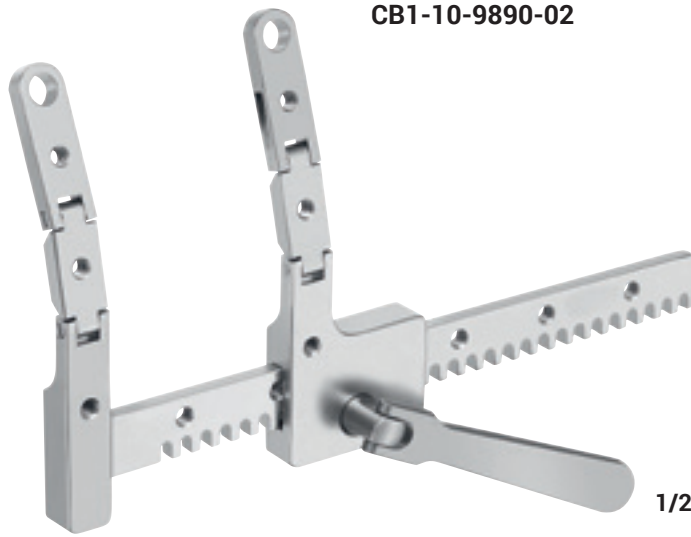

**MIDCAB Adapter**

CB1-10-9890-01



**MIDCAB Stabilizer**

CB1-10-9890-03



**CARDIOVASCULAR RETRACTOR**

# CARDIOVASCULAR RETRACTOR

## MIDCAB Double Blades (solid individually)

CB1-10-9890-40

40 mm



1/2

CB1-10-9890-50

50 mm



1/2

CB1-10-9890-60

60 mm



1/2



1/2

CB1-10-9890-70

70 mm



1/2

CB1-10-9890-80

80 mm



### SKILL MICS Aortic Clamp Set

The system is easily introduced and removed through the MICS Retractor. This eliminated the need for a dedicated aortic clamp Incision/access, further reducing potential risks to patients. It is designed so the handle is removed after the insertion of the clamp, eliminating visual impedance of the operating field.



CB1-195.98



CB1-195.99



Aortic Clamp Set Straight  
CB1-195.80



Aortic Clamp Set Right  
CB1-195.90



Aortic Clamp Set Left  
CB1-195.70

Name	Description	Code
MICS Aortic Clamp Set Left 2x3 DeBakey	Set Left: Small 75 mm, Medium 85 mm, Large 95 mm	CB1-195.70
MICS Aortic Clamp Set Straight 2x3 DeBakey	Set Straight: Small 75 mm, Medium 85 mm, Large 95 mm	CB1-195.80
MICS Aortic Clamp Set Right 2x3 DeBakey	Set Right: Small 75 mm, Medium 85 mm, Large 95 mm	CB1-195.90

**SKILL MICS Aortic Clamp Set**

The system is easily introduced and removed through the MICS Retractor. This eliminated the need for a dedicated aortic clamp incision/access, further reducing potential risks to patients. It is designed so the handle is removed after the insertion of the clamp, eliminating visual impedance of the operating field.



CB1-195.98



CB1-195.99



Aortic Clamp Set Left Bent

**CB1-195.75**



Aortic Clamp Set Right

**CB1-195.85**

Name	Description	Code
MICS Aortic Clamp Set Left Bent 2x3 DeBakey	Set Left: Small 75 mm, Medium 85 mm, Large 95 mm	CB1-195.75
MICS Aortic Clamp Set Right Bent 2x3 DeBakey	Set Right: Small 75 mm, Medium 85 mm, Large 95 mm	CB1-195.85

**SKILL MICS Aortic Parallel Clamp Set**

The system is easily introduced and removed through the MICS Retractor. The new MICS Aortic Parallel Clamp Set reduces significantly and even more the vessel traumatic effects close by zero percent and potential risks to patients, compared to the Standard Aortic Clamps.



CB1-195.98



CB1-195.99



CB1-185.95



MICS Aortic Parallel Clamp Set  
CB1-185.85



Name	Description	Code
MICS Aortic Parallel Clamp Set Left Curved	Set: Small 60 mm, Medium 70 mm	CB1-185.75
MICS Aortic Parallel Clamp Set Straight	Set: Small 60 mm, Medium 70 mm	CB1-185.85
MICS Aortic Parallel Clamp Set Right Curved	Set: Small 60 mm, Medium 70 mm	CB1-185.95

**SKILL MICS Atrial Blade Set**

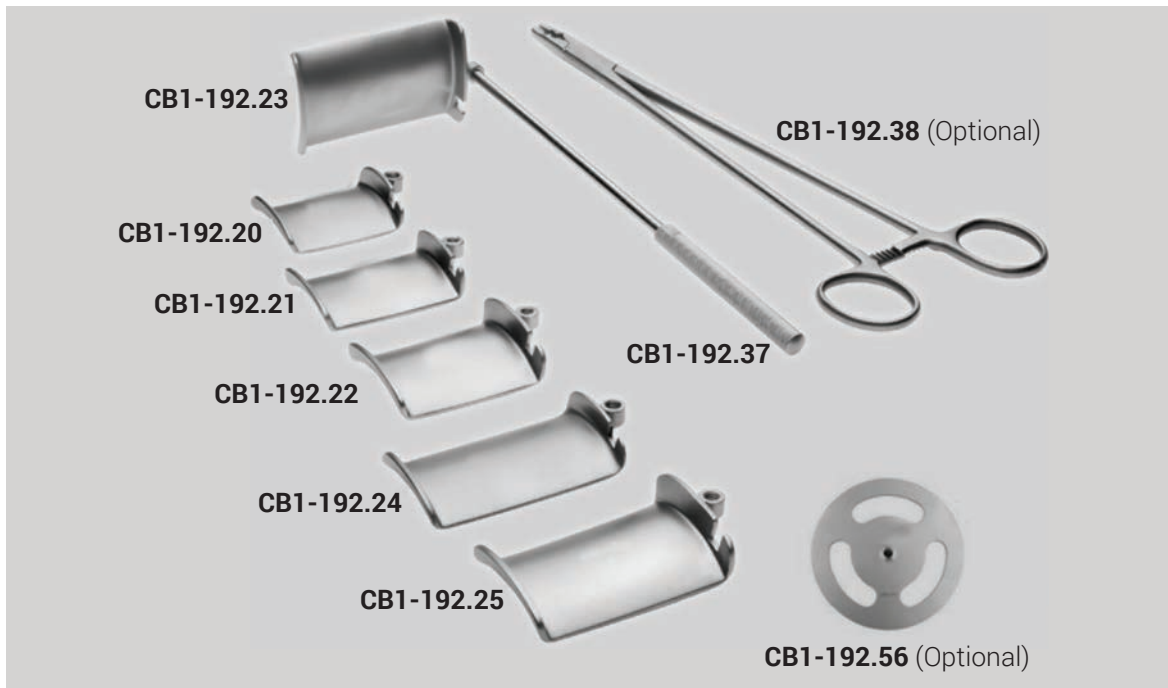

Name	Description	Code
MICS Atrial Mitral Blade Set	Containing Holder, Forceps and Blades: CB1-192.37, CB1-192.20, CB1-192.21, CB1-192.22, CB1-192.23, CB1-192.24, CB1-192.25	CB1-192.75

MICS Holding Fixation Platform	Diameter 95 mm	CB1-192.56 (Optional)
MICS Holder Forceps for Atrial Blades	140 mm	CB1-192.37
MICS Forceps for Atrial Blades	250 mm	CB1-192.38 (Optional)
MICS Atrial Blade	35 x 40 mm (BXL)	CB1-192.20
MICS Atrial Blade	35 x 40 mm (BXL)	CB1-192.21
MICS Atrial Blade	35 x 60 mm (BXL)	CB1-192.22
MICS Atrial Blade	40 x 50 mm (BXL)	CB1-192.23
MICS Atrial Blade	40 x 60 mm (BXL)	CB1-192.24
MICS Atrial Blade	40 x 70 mm (BXL)	CB1-192.25

Name	Description	Code
MICS Atrial Tricuspidal Blade Set	Containing Holder, Forceps and Blades: CB1-192.37, CB1-192.40, CB1-192.41, CB1-192.42, CB1-192.43, CB1-192.44, CB1-192.45	CB1-192.76

MICS Holding Fixation Platform	Diameter 95 mm	CB1-192.56 (Optional)
MICS Holder Forceps for Atrial Blades	140 mm	CB1-192.37
MICS Forceps for Atrial Blades	250 mm	CB1-192.38 (Optional)
MICS Atrial Blade	20 x 40 mm (BXL)	CB1-192.40
MICS Atrial Blade	20 x 25 mm (BXL)	CB1-192.41
MICS Atrial Blade	25 x 25 mm (BXL)	CB1-192.42
MICS Atrial Blade	25 x 50 mm (BXL)	CB1-192.43
MICS Atrial Blade	40 x 25 mm (BXL)	CB1-192.44
MICS Atrial Blade	50 x 25 mm (BXL)	CB1-192.45



# SKILL<sup>®</sup>

Surgical Instruments

## MICS & VATS CARDIAC INSTRUMENTS





# Index

## MICS Vats Cardiac Instruments

Scissors	369- 376
Grasping Forceps	377-382
Needle Holders	383-389
Special Instruments	390-395
Chest Tube Passers	396
CMICS Instruments   VATS Instruments	398
VATS Scissors	399-401
VATS Needle Holder	401-402
VATS DeBakey Clamp	402-404
VATS Harken and Satinsky Clamp	405-408
VATS Foerster Lung Grasping Clamp	409-411
VATS Dissector Clamp	411-414
VATS Duval Lung Grasping Clamp	414
Valve Extra Long Rongeurs	415
Dissector Sliding Clamp	415-416
Sliding Scissors Super Cut	417
Double Action Grasper Clamp Hallmann   Double Action Scissors	418
D'Amico Biopsy Forceps	419
Gonzalez-Rivas Lung Grasping Clamp	420
Foerster Lung Grasping Clamp	421
Node Grasping Clamp   Khan Decortication Grasper	423
Gonzalez-Rivas Dissector	424-426
Snake Dissector Small	424-425
Dennis Dissector	425
Harken Clamps	426
Allis Forceps	427
MICS Suction Instrument   Knot Pusher   Cardioplegia Needle   Magnet Finder	428
Endo TC Needle Holder	429-437
Clip applying Forceps Ø 10.0 mm for Bulldog Clamps	437
Bulldog Clamps DeBakey	438
Fan Retractors	439-440
Endo Retractors	440-445
SKILL Thoracic Suction Tube	445-447
Adam Yozu Retractor	448-450
Mini-Thoracotomy Retractors	451-452
Fixation Clamps	452

# MICS & VATS INSTRUMENTS



## CARDIO VASCULAR INSTRUMENTS



SCISSORS

GRASPING FORCEPS

NEEDLE HOLDERS

SPECIAL INSTRUMENTS



**Handles**

Handle 50D ... *Flush-port on the Shaft*

**Scissors Red**



**Grasping Forceps Gold**

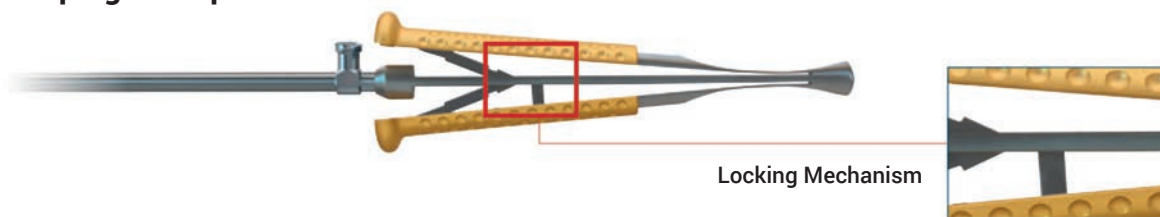

**Needle Holder Blue**



**Special Instruments Green**



**Dimensions**

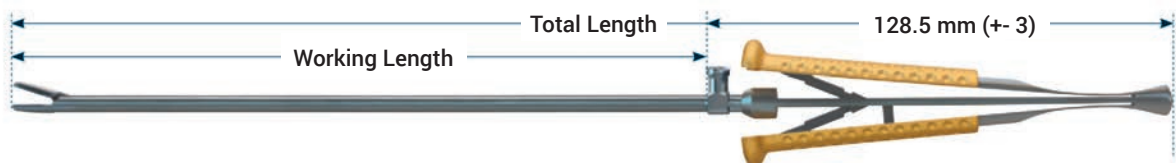

# MICS & VATS INSTRUMENTS

## Handles

Handle 51D ... *Flush-port at the end of the handle*

### Scissors Red

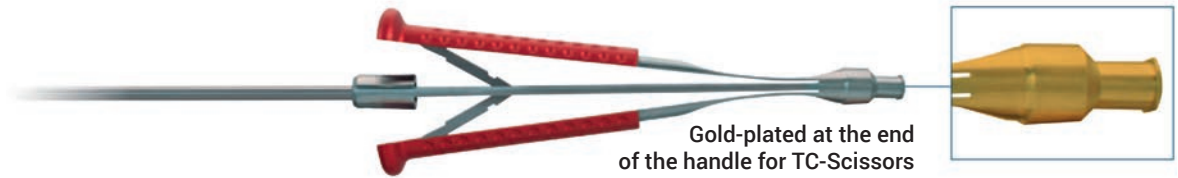

### Grasping Forceps Gold

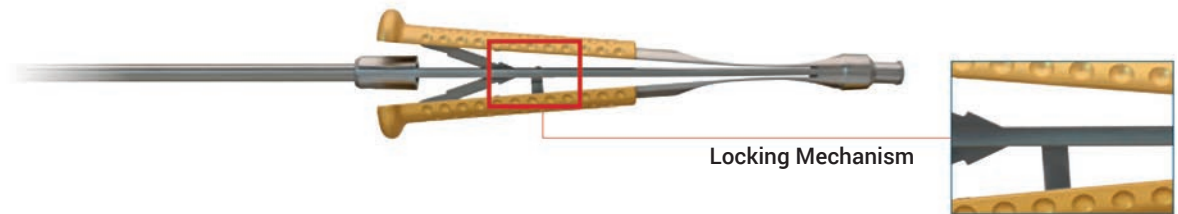

### Needle Holder Blue

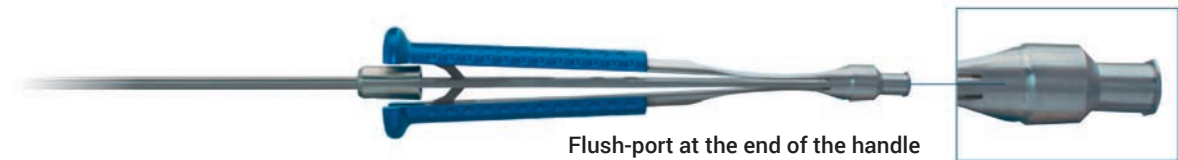

### Special Instruments Green



## Dimensions

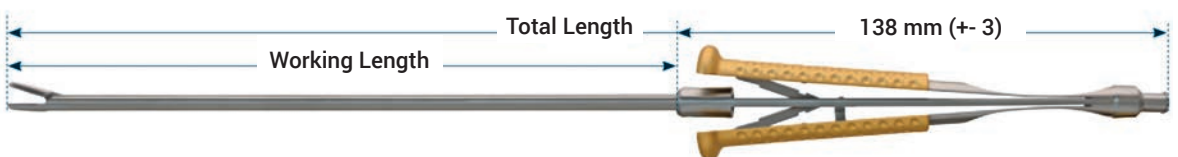

Scissors



Scissors Single Action, Angled 25°

Working/Total Length	Jaw-Ø	Shaft-Ø	Code	Locking	Tip
151 mm / 300 mm	3 mm	3 mm	FR-2000-30		
211 mm / 350 mm	3 mm	3 mm	FR-2000-35		
261 mm / 400 mm	3 mm	3 mm	FR-2000-40		



Scissors Single Action, Angled 45°

Working/Total Length	Jaw-Ø	Shaft-Ø	Code	Locking	Tip
151 mm / 300 mm	3 mm	3 mm	FR-2001-30		
211 mm / 350 mm	3 mm	3 mm	FR-2001-35		
261 mm / 400 mm	3 mm	3 mm	FR-2001-40		



Scissors Single Action, Angled 60°

Working/Total Length	Jaw-Ø	Shaft-Ø	Code	Locking	Tip
151 mm / 300 mm	3 mm	3 mm	FR-2002-30		
211 mm / 350 mm	3 mm	3 mm	FR-2002-35		
261 mm / 400 mm	3 mm	3 mm	FR-2002-40		



Scissors Single Action, Angled 90°

Working/Total Length	Jaw-Ø	Shaft-Ø	Code	Locking	Tip
151 mm / 300 mm	3 mm	3 mm	FR-2003-30		
211 mm / 350 mm	3 mm	3 mm	FR-2003-35		
261 mm / 400 mm	3 mm	3 mm	FR-2003-40		



Scissors

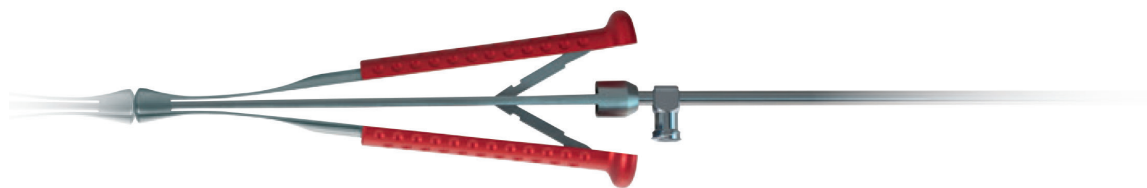

Scissors Single Action, Angled 120°

Working/Total Length	Jaw-Ø	Shaft-Ø	Code	Locking	Tip
151 mm / 300 mm	3 mm	3 mm	FR-2004-30		
211 mm / 350 mm	3 mm	3 mm	FR-2004-35		
261 mm / 400 mm	3 mm	3 mm	FR-2004-40		



Scissors Single Action, Straight

Working/Total Length	Jaw-Ø	Shaft-Ø	Code	Locking	Tip
161 mm / 300 mm	3.5 mm	3.4 mm	FR-2005-30		
221 mm / 350 mm	3.5 mm	3.4 mm	FR-2005-35		
271 mm / 400 mm	3.5 mm	3.4 mm	FR-2005-40		



Scissors Single Action, Angled 45°

Working/Total Length	Jaw-Ø	Shaft-Ø	Code	Locking	Tip
161 mm / 300 mm	3.5 mm	3.4 mm	FR-2006-30		
221 mm / 350 mm	3.5 mm	3.4 mm	FR-2006-35		
271 mm / 400 mm	3.5 mm	3.4 mm	FR-2006-40		



Scissors Single Action, Angled 90°

Working/Total Length	Jaw-Ø	Shaft-Ø	Code	Locking	Tip
151 mm / 300 mm	3.5 mm	3.4 mm	FR-2007-30		
211 mm / 350 mm	3.5 mm	3.4 mm	FR-2007-35		
261 mm / 400 mm	3.5 mm	3.4 mm	FR-2007-40		



Scissors

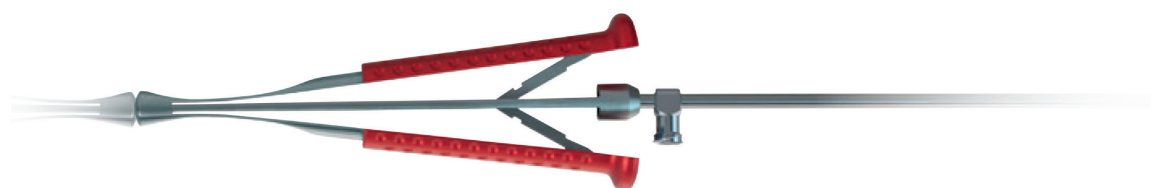

Scissors Single Action, Angled 120°

Working/Total Length	Jaw-Ø	Shaft-Ø	Code	Locking	Tip
151 mm / 300 mm	3.5 mm	3.4 mm	FR-2008-30		
211 mm / 350 mm	3.5 mm	3.4 mm	FR-2008-35		
261 mm / 400 mm	3.5 mm	3.4 mm	FR-2008-40		



Scissors Single Action, Curved Right

Working/Total Length	Jaw-Ø	Shaft-Ø	Code	Locking	Tip
161 mm / 300 mm	3.5 mm	3.4 mm	FR-2009-30		
221 mm / 350 mm	3.5 mm	3.4 mm	FR-2009-35		
271 mm / 400 mm	3.5 mm	3.4 mm	FR-2009-40		



Scissors Single Action, Curved Left

Working/Total Length	Jaw-Ø	Shaft-Ø	Code	Locking	Tip
161 mm / 300 mm	3.5 mm	3.4 mm	FR-2010-30		
221 mm / 350 mm	3.5 mm	3.4 mm	FR-2010-35		
271 mm / 400 mm	3.5 mm	3.4 mm	FR-2010-40		



Scissors Single Action, Angled 30°

Working/Total Length	Jaw-Ø	Shaft-Ø	Code	Locking	Tip
174 mm / 300 mm	5 mm	5 mm	FR-2011-30		
224 mm / 350 mm	5 mm	5 mm	FR-2011-35		
274 mm / 400 mm	5 mm	5 mm	FR-2011-40		



Scissors

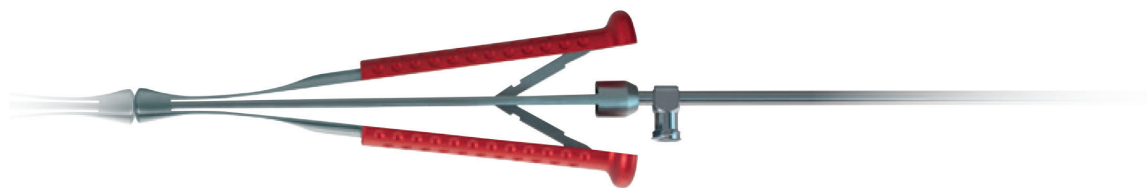

Scissors Single Action, Angled 45°

Working/Total Length	Jaw-Ø	Shaft-Ø	Code	Locking	Tip
174 mm / 300 mm	5 mm	5 mm	FR-2012-30		
224 mm / 350 mm	5 mm	5 mm	FR-2012-35		
274 mm / 400 mm	5 mm	5 mm	FR-2012-40		



Scissors Single Action, Angled 90°

Working/Total Length	Jaw-Ø	Shaft-Ø	Code	Locking	Tip
164 mm / 300 mm	5 mm	5 mm	FR-2013-30		
214 mm / 350 mm	5 mm	5 mm	FR-2013-35		
264 mm / 400 mm	5 mm	5 mm	FR-2013-40		



Scissors Single Action, Angled 30°

Working/Total Length	Jaw-Ø	Shaft-Ø	Code	Locking	Tip
161 mm / 300 mm	5 mm	3.4 mm	FR-2014-30		
221 mm / 350 mm	5 mm	3.4 mm	FR-2014-35		
271 mm / 400 mm	5 mm	3.4 mm	FR-2014-40		



Scissors Single Action, Angled 90°

Working/Total Length	Jaw-Ø	Shaft-Ø	Code	Locking	Tip
161 mm / 300 mm	5 mm	3.4 mm	FR-2015-30		
221 mm / 350 mm	5 mm	3.4 mm	FR-2015-35		
271 mm / 400 mm	5 mm	3.4 mm	FR-2015-40		



Scissors

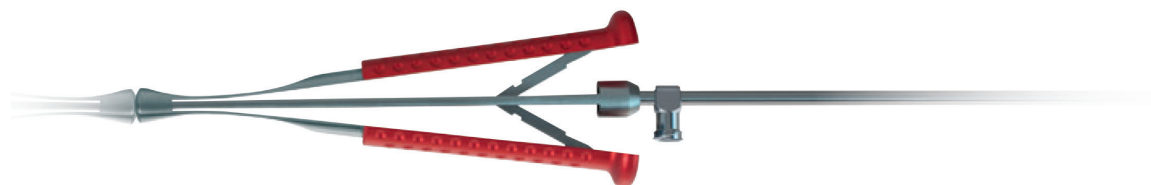

Scissors Single Action, Curved Left Medium

Working/Total Length	Jaw-Ø	Shaft-Ø	Code	Locking	Tip
174 mm / 300 mm	5 mm	5 mm	FR-2016-30		
224 mm / 350 mm	5 mm	5 mm	FR-2016-35		
274 mm / 400 mm	5 mm	5 mm	FR-2016-40		



Scissors Single Action, Curved Left Strongly

Working/Total Length	Jaw-Ø	Shaft-Ø	Code	Locking	Tip
174 mm / 300 mm	5 mm	5 mm	FR-2017-30		
224 mm / 350 mm	5 mm	5 mm	FR-2017-35		
274 mm / 400 mm	5 mm	5 mm	FR-2017-40		



Scissors Double Action, Curved Medium

Working/Total Length	Jaw-Ø	Shaft-Ø	Code	Locking	Tip
161 mm / 300 mm	3.5 mm	3.4 mm	FR-2018-30		
221 mm / 350 mm	3.5 mm	3.4 mm	FR-2018-35		
271 mm / 400 mm	3.5 mm	3.4 mm	FR-2018-40		



Scissors Double Action, Straight

Working/Total Length	Jaw-Ø	Shaft-Ø	Code	Locking	Tip
184 mm / 300 mm	5 mm	5 mm	FR-2019-30		
234 mm / 350 mm	5 mm	5 mm	FR-2019-35		
284 mm / 400 mm	5 mm	5 mm	FR-2019-40		



Scissors

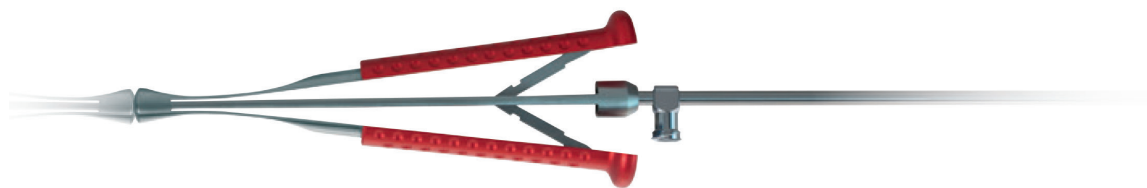

Scissors Double Action, Curved Strictly

Working/Total Length	Jaw-Ø	Shaft-Ø	Code	Locking	Tip
184 mm / 300 mm	5 mm	5 mm	FR-2020-30		
234 mm / 350 mm	5 mm	5 mm	FR-2020-35		
284 mm / 400 mm	5 mm	5 mm	FR-2020-40		



Scissors Double Action, Curved Medium

Working/Total Length	Jaw-Ø	Shaft-Ø	Code	Locking	Tip
184 mm / 300 mm	5 mm	5 mm	FR-2021-30		
234 mm / 350 mm	5 mm	5 mm	FR-2021-35		
284 mm / 400 mm	5 mm	5 mm	FR-2021-40		



Scissors Double Action, Curved Strongly

Working/Total Length	Jaw-Ø	Shaft-Ø	Code	Locking	Tip
184 mm / 300 mm	5 mm	5 mm	FR-2022-30		
234 mm / 350 mm	5 mm	5 mm	FR-2022-35		
284 mm / 400 mm	5 mm	5 mm	FR-2022-40		



Scissors Double Action, TC-Insert, Curved Slightly One Blade Serrated

Working/Total Length	Jaw-Ø	Shaft-Ø	Code	Locking	Tip
184 mm / 300 mm	5 mm	5 mm	FR-2023-30		TC-Insert
234 mm / 350 mm	5 mm	5 mm	FR-2023-35		TC-Insert
284 mm / 400 mm	5 mm	5 mm	FR-2023-40		TC-Insert



Scissors

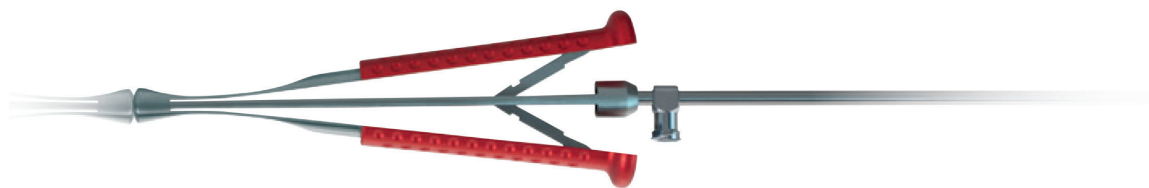

Scissors Double Action, TC-Insert, Curved Medium One Blade Serrated

Working/Total Length	Jaw-Ø	Shaft-Ø	Code	Locking	Tip
184 mm / 300 mm	5 mm	5 mm	FR-2024-30		TC-Insert
234 mm / 350 mm	5 mm	5 mm	FR-2024-35		TC-Insert
284 mm / 400 mm	5 mm	5 mm	FR-2024-40		TC-Insert



Scissors Tenotomy Double Action, Curved Slightly

Working/Total Length	Jaw-Ø	Shaft-Ø	Code	Locking	Tip
184 mm / 300 mm	5 mm	5 mm	FR-2025-30		
234 mm / 350 mm	5 mm	5 mm	FR-2025-35		
284 mm / 400 mm	5 mm	5 mm	FR-2025-40		



Scissors Tenotomy Double Action, Curved Medium

Working/Total Length	Jaw-Ø	Shaft-Ø	Code	Locking	Tip
184 mm / 300 mm	5 mm	5 mm	FR-2026-30		
234 mm / 350 mm	5 mm	5 mm	FR-2026-35		
284 mm / 400 mm	5 mm	5 mm	FR-2026-40		

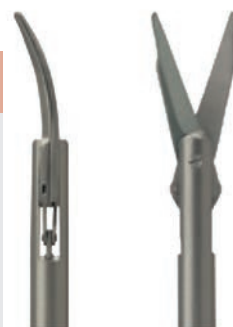

**Scissors**

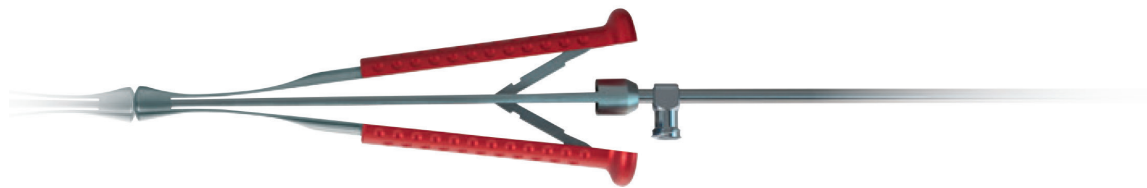

**Scissors Heavy Double Action, Curved Slightly**

Working/Total Length	Jaw-Ø	Shaft-Ø	Code	Locking	Tip
184 mm / 300 mm	7 mm	5 mm	FR-2027-30		
234 mm / 350 mm	7 mm	5 mm	FR-2027-35		
284 mm / 400 mm	7 mm	5 mm	FR-2027-40		



**Scissors Heavy Double Action, Curved Medium**

Working/Total Length	Jaw-Ø	Shaft-Ø	Code	Locking	Tip
184 mm / 300 mm	7 mm	5 mm	FR-2028-30		
234 mm / 350 mm	7 mm	5 mm	FR-2028-35		
284 mm / 400 mm	7 mm	5 mm	FR-2028-40		



**Scissors Heavy Double Action, Curved Strongly**

Working/Total Length	Jaw-Ø	Shaft-Ø	Code	Locking	Tip
184 mm / 300 mm	7 mm	5 mm	FR-2029-30		
234 mm / 350 mm	7 mm	5 mm	FR-2029-35		
284 mm / 400 mm	7 mm	5 mm	FR-2029-40		



## Grasping Forceps

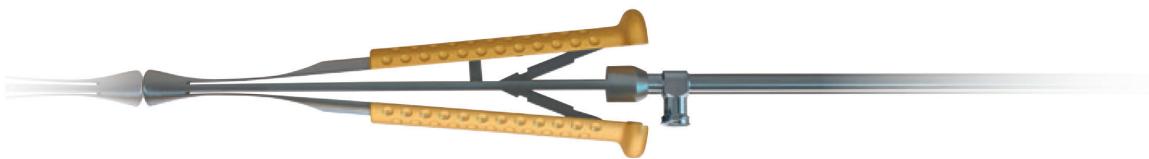

### Grasper DeBakey Single Action, Straight 1,5 mm

Working/Total Length	Jaw-Ø	Shaft-Ø	Code	Locking	Tip
171 mm / 300 mm	3.5 mm	3.4 mm	FR-3000-30		1 x 2 Teeth
231 mm / 350 mm	3.5 mm	3.4 mm	FR-3000-35		1 x 2 Teeth
281 mm / 400 mm	3.5 mm	3.4 mm	FR-3000-40		1 x 2 Teeth



### Grasper DeBakey Single Action, Straight 2,8 mm

Working/Total Length	Jaw-Ø	Shaft-Ø	Code	Locking	Tip
171 mm / 300 mm	3.5 mm	3.4 mm	FR-3001-30		1 x 2 Teeth
231 mm / 350 mm	3.5 mm	3.4 mm	FR-3001-35		1 x 2 Teeth
281 mm / 400 mm	3.5 mm	3.4 mm	FR-3001-40		1 x 2 Teeth



### Grasper DeBakey Single Action, Upwards 45°

Working/Total Length	Jaw-Ø	Shaft-Ø	Code	Locking	Tip
161 mm / 300 mm	3.5 mm	3.4 mm	FR-3002-30		1 x 2 Teeth
221 mm / 350 mm	3.5 mm	3.4 mm	FR-3002-35		1 x 2 Teeth
271 mm / 400 mm	3.5 mm	3.4 mm	FR-3002-40		1 x 2 Teeth



### Grasper DeBakey Single Action, Angled Right 45°

Working/Total Length	Jaw-Ø	Shaft-Ø	Code	Locking	Tip
171 mm / 300 mm	3.5 mm	3.4 mm	FR-3003-30		1 x 2 Teeth
231 mm / 350 mm	3.5 mm	3.4 mm	FR-3003-35		1 x 2 Teeth
281 mm / 400 mm	3.5 mm	3.4 mm	FR-3003-40		1 x 2 Teeth



**Grasping Forceps**

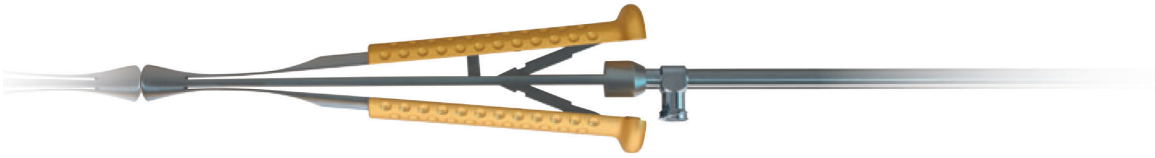

**Grasper DeBakey Signle Action, Angled Left 45°**

Working/Total Length	Jaw-Ø	Shaft-Ø	Code	Locking	Tip
171 mm / 300 mm	3.5 mm	3.4 mm	FR-3004-30		1 x 2 Teeth
231 mm / 350 mm	3.5 mm	3.4 mm	FR-3004-35		1 x 2 Teeth
281 mm / 400 mm	3.5 mm	3.4 mm	FR-3004-40		1 x 2 Teeth



**Grasper DeBakey Signle Action, Upwards 45°**

Working/Total Length	Jaw-Ø	Shaft-Ø	Code	Locking	Tip
184 mm / 300 mm	3.5 mm	5 mm	FR-3005-30		1 x 2 Teeth
234 mm / 350 mm	3.5 mm	5 mm	FR-3005-35		1 x 2 Teeth
284 mm / 400 mm	3.5 mm	5 mm	FR-3005-40		1 x 2 Teeth



**Grasper DeBakey Signle Action, Angled Right 45°**

Working/Total Length	Jaw-Ø	Shaft-Ø	Code	Locking	Tip
184 mm / 300 mm	3.5 mm	5 mm	FR-3006-30		1 x 2 Teeth
234 mm / 350 mm	3.5 mm	5 mm	FR-3006-35		1 x 2 Teeth
284 mm / 400 mm	3.5 mm	5 mm	FR-3006-40		1 x 2 Teeth



**Grasper DeBakey Double Action, Straight 1,5 mm**

Working/Total Length	Jaw-Ø	Shaft-Ø	Code	Locking	Tip
171 mm / 300 mm	3.5 mm	3.4 mm	FR-3007-30		1 x 2 Teeth
231 mm / 350 mm	3.5 mm	3.4 mm	FR-3007-35		1 x 2 Teeth
281 mm / 400 mm	3.5 mm	3.4 mm	FR-3007-40		1 x 2 Teeth



## Grasping Forceps

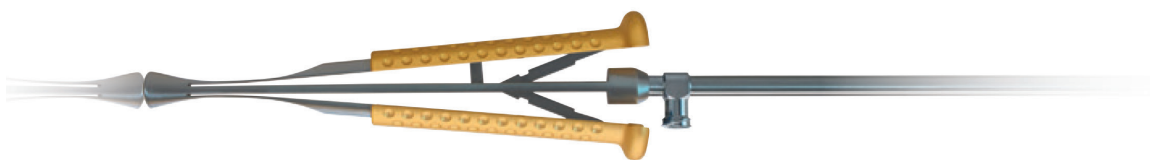

### Grasper DeBakey Double Action, Angled 45°

Working/Total Length	Jaw-Ø	Shaft-Ø	Code	Locking	Tip
171 mm / 300 mm	3.5 mm	3.4 mm	FR-3008-30		1 x 2 Teeth
231 mm / 350 mm	3.5 mm	3.4 mm	FR-3008-35		1 x 2 Teeth
281 mm / 400 mm	3.5 mm	3.4 mm	FR-3008-40		1 x 2 Teeth



### Grasper DeBakey Double Action, Straight 1,5 mm

Working/Total Length	Jaw-Ø	Shaft-Ø	Code	Locking	Tip
184 mm / 300 mm	5 mm	5 mm	FR-3009-30		1 x 2 Teeth
234 mm / 350 mm	5 mm	5 mm	FR-3009-35		1 x 2 Teeth
284 mm / 400 mm	5 mm	5 mm	FR-3009-40		1 x 2 Teeth



### Grasper DeBakey Double Action, Straight, Malleable Shaft, 1,5 mm

Working/Total Length	Jaw-Ø	Shaft-Ø	Code	Locking	Tip
171 mm / 300 mm	5 mm	3 mm	FR-3010-30		1 x 2 Teeth
231 mm / 350 mm	5 mm	3 mm	FR-3010-35		1 x 2 Teeth
281 mm / 400 mm	5 mm	3 mm	FR-3010-40		1 x 2 Teeth



### Grasper DeBakey Double Action, Angled 45° 1,5 x 15 mm

Working/Total Length	Jaw-Ø	Shaft-Ø	Code	Locking	Tip
184 mm / 300 mm	5 mm	5 mm	FR-3011-30		1 x 2 Teeth
234 mm / 350 mm	5 mm	5 mm	FR-3011-35		1 x 2 Teeth
284 mm / 400 mm	5 mm	5 mm	FR-3011-40		1 x 2 Teeth



**Grasping Forceps**

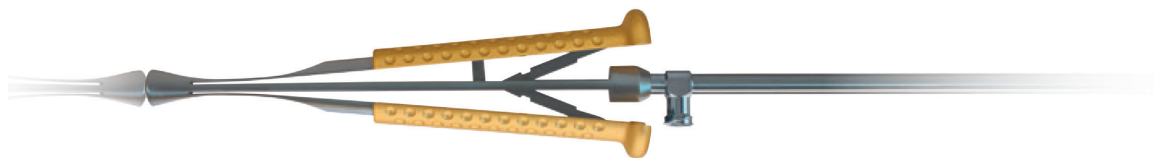

**Grasper DeBakey Double Action, Straight 2,8 mm**

Working/Total Length	Jaw-Ø	Shaft-Ø	Code	Locking	Tip
184 mm / 300 mm	5 mm	5 mm	FR-3012-30		1 x 2 Teeth
234 mm / 350 mm	5 mm	5 mm	FR-3012-35		1 x 2 Teeth
284 mm / 400 mm	5 mm	5 mm	FR-3012-40		1 x 2 Teeth



**Grasper DeBakey Double Action, Angled 45° 2,8 mm**

Working/Total Length	Jaw-Ø	Shaft-Ø	Code	Locking	Tip
184 mm / 300 mm	5 mm	5 mm	FR-3013-30		1 x 2 Teeth
234 mm / 350 mm	5 mm	5 mm	FR-3013-35		1 x 2 Teeth
284 mm / 400 mm	5 mm	5 mm	FR-3013-40		1 x 2 Teeth



**Grasper DeBakey Double Action, Wide, Straight**

Working/Total Length	Jaw-Ø	Shaft-Ø	Code	Locking	Tip
184 mm / 300 mm	5 mm	5 mm	FR-3014-30		1 x 2 Teeth
234 mm / 350 mm	5 mm	5 mm	FR-3014-35		1 x 2 Teeth
284 mm / 400 mm	5 mm	5 mm	FR-3014-40		1 x 2 Teeth



**Grasper DeBakey Double Action, Extra Wide, Straight**

Working/Total Length	Jaw-Ø	Shaft-Ø	Code	Locking	Tip
193 mm / 300 mm	5 mm	5 mm	FR-3015-30		1 x 2 Teeth
243 mm / 350 mm	5 mm	5 mm	FR-3015-35		1 x 2 Teeth
293 mm / 400 mm	5 mm	5 mm	FR-3015-40		1 x 2 Teeth



## Grasping Forceps

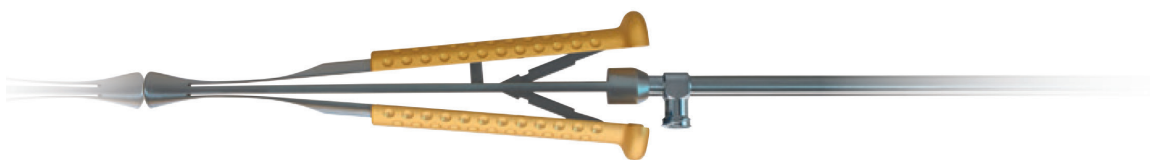

### Resano Grasper Single Action, Straight

Working/Total Length	Jaw-Ø	Shaft-Ø	Code	Locking	Tip
184 mm / 300 mm	5 mm	5 mm	FR-3016-30		
234 mm / 350 mm	5 mm	5 mm	FR-3016-35		
284 mm / 400 mm	5 mm	5 mm	FR-3016-40		



### Resano Grasper Double Action, Straight

Working/Total Length	Jaw-Ø	Shaft-Ø	Code	Locking	Tip
184 mm / 300 mm	5 mm	5 mm	FR-3017-30		
234 mm / 350 mm	5 mm	5 mm	FR-3017-35		
284 mm / 400 mm	5 mm	5 mm	FR-3017-40		



### Resano Grasper Double Action, Straight With Lock

Working/Total Length	Jaw-Ø	Shaft-Ø	Code	Locking	Tip
184 mm / 300 mm	5 mm	5 mm	FR-3018-30	☼	
234 mm / 350 mm	5 mm	5 mm	FR-3018-35	☼	
284 mm / 400 mm	5 mm	5 mm	FR-3018-40	☼	



### Russian Grasper Double Action, Straight

Working/Total Length	Jaw-Ø	Shaft-Ø	Code	Locking	Tip
184 mm / 300 mm	5 mm	5 mm	FR-3019-30		
234 mm / 350 mm	5 mm	5 mm	FR-3019-35		
284 mm / 400 mm	5 mm	5 mm	FR-3019-40		



Grasping Forceps

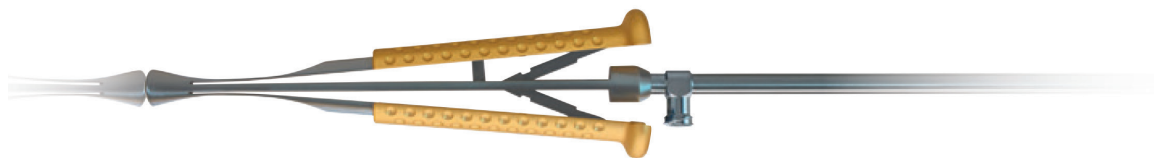

Russian Grasper Double Action, Angled 30°

Working/Total Length	Jaw-Ø	Shaft-Ø	Code	Locking	Tip
184 mm / 300 mm	5 mm	5 mm	FR-3020-30		
234 mm / 350 mm	5 mm	5 mm	FR-3020-35		
284 mm / 400 mm	5 mm	5 mm	FR-3020-400		

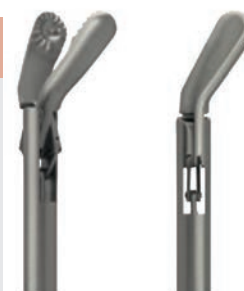

Cup-Shaped Forceps Single Action, Oval

Working/Total Length	Jaw-Ø	Shaft-Ø	Code	Locking	Tip
161 mm / 300 mm	3.5 mm	3.4 mm	FR-3021-30		
221 mm / 350 mm	3.5 mm	3.4 mm	FR-3021-35		
271 mm / 400 mm	3.5 mm	3.4 mm	FR-3021-40		



Cup-Shaped Forceps Single Action, Oval

Working/Total Length	Jaw-Ø	Shaft-Ø	Code	Locking	Tip
174 mm / 300 mm	5 mm	5 mm	FR-3022-30		
224 mm / 350 mm	5 mm	5 mm	FR-3022-35		
274 mm / 400 mm	5 mm	5 mm	FR-3022-40		



Cup-Shaped Forceps Single Action, Oval Upwards 30°

Working/Total Length	Jaw-Ø	Shaft-Ø	Code	Locking	Tip
174 mm / 300 mm	5 mm	5 mm	FR-3023-30		
224 mm / 350 mm	5 mm	5 mm	FR-3023-35		
274 mm / 400 mm	5 mm	5 mm	FR-3023-40		



## Needle Holders



### Needle Holder Single Action, Straight

Working/Total Length	Jaw-Ø	Shaft-Ø	Code	Locking	Tip
161 mm / 300 mm	2.7 mm	2.7 mm	FR-4000-30	☼	TC-Insert
221 mm / 350 mm	2.7 mm	2.7 mm	FR-4000-35	☼	TC-Insert
271 mm / 400 mm	2.7 mm	2.7 mm	FR-4000-40	☼	TC-Insert



### Needle Holder Single Action, Curved Left

Working/Total Length	Jaw-Ø	Shaft-Ø	Code	Locking	Tip
161 mm / 300 mm	2.7 mm	2.7 mm	FR-4001-30	☼	TC-Insert
221 mm / 350 mm	2.7 mm	2.7 mm	FR-4001-35	☼	TC-Insert
271 mm / 400 mm	2.7 mm	2.7 mm	FR-4001-40	☼	TC-Insert



### Needle Holder Single Action, Straight

Working/Total Length	Jaw-Ø	Shaft-Ø	Code	Locking	Tip
161 mm / 300 mm	3.5 mm	3.4 mm	FR-4002-30	☼	TC-Insert
221 mm / 350 mm	3.5 mm	3.4 mm	FR-4002-35	☼	TC-Insert
271 mm / 400 mm	3.5 mm	3.4 mm	FR-4002-40	☼	TC-Insert



### Needle Holder Single Action, Curved Left

Working/Total Length	Jaw-Ø	Shaft-Ø	Code	Locking	Tip
161 mm / 300 mm	3.5 mm	3.4 mm	FR-4003-30	☼	TC-Insert
221 mm / 350 mm	3.5 mm	3.4 mm	FR-4003-35	☼	TC-Insert
271 mm / 400 mm	3.5 mm	3.4 mm	FR-4003-40	☼	TC-Insert



Needle Holders



Needle Holder Single Action, Curved Right

Working/Total Length	Jaw-Ø	Shaft-Ø	Code	Locking	Tip
161 mm / 300 mm	3.5 mm	3.4 mm	FR-4004-30	☒	TC-Insert
221 mm / 350 mm	3.5 mm	3.4 mm	FR-4004-35	☒	TC-Insert
271 mm / 400 mm	3.5 mm	3.4 mm	FR-4004-40	☒	TC-Insert



Needle Holder Single Action, Straight

Working/Total Length	Jaw-Ø	Shaft-Ø	Code	Locking	Tip
174 mm / 300 mm	5 mm	5 mm	FR-4005-30	☒	TC-Insert
224 mm / 350 mm	5 mm	5 mm	FR-4005-35	☒	TC-Insert
274 mm / 400 mm	5 mm	5 mm	FR-4005-40	☒	TC-Insert



Needle Holder Single Action, Curved Left

Working/Total Length	Jaw-Ø	Shaft-Ø	Code	Locking	Tip
174 mm / 300 mm	5 mm	5 mm	FR-4006-30	☒	TC-Insert
224 mm / 350 mm	5 mm	5 mm	FR-4006-35	☒	TC-Insert
274 mm / 400 mm	5 mm	5 mm	FR-4006-40	☒	TC-Insert



Needle Holder Single Action, Curved Right

Working/Total Length	Jaw-Ø	Shaft-Ø	Code	Locking	Tip
174 mm / 300 mm	5 mm	5 mm	FR-4007-30	☒	TC-Insert
224 mm / 350 mm	5 mm	5 mm	FR-4007-35	☒	TC-Insert
274 mm / 400 mm	5 mm	5 mm	FR-4007-40	☒	TC-Insert



## Needle Holders



### Needle Holder Single Action, Angled 45°

Working/Total Length	Jaw-Ø	Shaft-Ø	Code	Locking	Tip
184 mm / 300 mm	5 mm	5 mm	FR-4008-30	☒	TC-Insert
234 mm / 350 mm	5 mm	5 mm	FR-4008-35	☒	TC-Insert
284 mm / 400 mm	5 mm	5 mm	FR-4008-40	☒	TC-Insert



### Needle Holder Ryder Single Action, Straight

Working/Total Length	Jaw-Ø	Shaft-Ø	Code	Locking	Tip
174 mm / 300 mm	5 mm	5 mm	FR-4009-30	☒	TC-Insert
224 mm / 350 mm	5 mm	5 mm	FR-4009-35	☒	TC-Insert
274 mm / 400 mm	5 mm	5 mm	FR-4009-40	☒	TC-Insert



### Needle Holder Colvin Single Action, Straight

Working/Total Length	Jaw-Ø	Shaft-Ø	Code	Locking	Tip
174 mm / 300 mm	5 mm	5 mm	FR-4010-30	☒	TC-Insert
224 mm / 350 mm	5 mm	5 mm	FR-4010-35	☒	TC-Insert
274 mm / 400 mm	5 mm	5 mm	FR-4010-40	☒	TC-Insert



### Needle Holder Colvin Single Action, Curved Left

Working/Total Length	Jaw-Ø	Shaft-Ø	Code	Locking	Tip
174 mm / 300 mm	5 mm	5 mm	FR-4011-30	☒	TC-Insert
224 mm / 350 mm	5 mm	5 mm	FR-4011-35	☒	TC-Insert
274 mm / 400 mm	5 mm	5 mm	FR-4011-40	☒	TC-Insert



Needle Holders



Needle Holder Single Action, Curved Left

Working/Total Length	Jaw-Ø	Shaft-Ø	Code	Locking	Tip
171 mm / 300 mm	5 mm	3.4 mm	FR-4012-30	☒	TC-Insert
231 mm / 350 mm	5 mm	3.4 mm	FR-4012-35	☒	TC-Insert
281 mm / 400 mm	5 mm	3.4 mm	FR-4012-40	☒	TC-Insert



Needle Holder Single Action, Straight Heavy

Working/Total Length	Jaw-Ø	Shaft-Ø	Code	Locking	Tip
174 mm / 300 mm	6 mm	5 mm	FR-4013-30	☒	TC-Insert
224 mm / 350 mm	6 mm	5 mm	FR-4013-35	☒	TC-Insert
274 mm / 400 mm	6 mm	5 mm	FR-4013-40	☒	TC-Insert



Needle Holder Single Action, Curved Left Heavy

Working/Total Length	Jaw-Ø	Shaft-Ø	Code	Locking	Tip
174 mm / 300 mm	6 mm	5 mm	FR-4014-30	☒	TC-Insert
224 mm / 350 mm	6 mm	5 mm	FR-4014-35	☒	TC-Insert
274 mm / 400 mm	6 mm	5 mm	FR-4014-40	☒	TC-Insert



Needle Holder Double Action Straight 1,5 mm

Working/Total Length	Jaw-Ø	Shaft-Ø	Code	Locking	Tip
174 mm / 300 mm	5 mm	5 mm	FR-4015-30	☒	TC-Insert
224 mm / 350 mm	5 mm	5 mm	FR-4015-35	☒	TC-Insert
274 mm / 400 mm	5 mm	5 mm	FR-4015-40	☒	TC-Insert



## Needle Holders



### Needle Holder Single Action, Curved Left

Working/Total Length	Jaw-Ø	Shaft-Ø	Code	Locking	Tip
161 mm / 300 mm	2.7 mm	2.7 mm	FR-4016-30	☼	TC-Coated
221 mm / 350 mm	2.7 mm	2.7 mm	FR-4016-35	☼	TC-Coated
271 mm / 400 mm	2.7 mm	2.7 mm	FR-4016-40	☼	TC-Coated



### Needle Holder Single Action, Straight

Working/Total Length	Jaw-Ø	Shaft-Ø	Code	Locking	Tip
161 mm / 300 mm	3.5 mm	3.4 mm	FR-4017-30	☼	TC-Coated
221 mm / 350 mm	3.5 mm	3.4 mm	FR-4017-35	☼	TC-Coated
271 mm / 400 mm	3.5 mm	3.4 mm	FR-4017-40	☼	TC-Coated



### Needle Holder Single Action, Curved Left

Working/Total Length	Jaw-Ø	Shaft-Ø	Code	Locking	Tip
161 mm / 300 mm	3.5 mm	3.4 mm	FR-4018-30	☼	TC-Coated
221 mm / 350 mm	3.5 mm	3.4 mm	FR-4018-35	☼	TC-Coated
271 mm / 400 mm	3.5 mm	3.4 mm	FR-4018-40	☼	TC-Coated



### Needle Holder Single Action, Curved Right, 2 x 8,5 mm

Working/Total Length	Jaw-Ø	Shaft-Ø	Code	Locking	Tip
161 mm / 300 mm	3.5 mm	3.4 mm	FR-4019-30	☼	TC-Coated
221 mm / 350 mm	3.5 mm	3.4 mm	FR-4019-35	☼	TC-Coated
271 mm / 400 mm	3.5 mm	3.4 mm	FR-4019-40	☼	TC-Coated



Needle Holders



Needle Holder Ryder Single Action, Straight

Working/Total Length	Jaw-Ø	Shaft-Ø	Code	Locking	Tip
161 mm / 300 mm	3.5 mm	3.4 mm	FR-4020-30	☒	TC-Coated
221 mm / 350 mm	3.5 mm	3.4 mm	FR-4020-35	☒	TC-Coated
271 mm / 400 mm	3.5 mm	3.4 mm	FR-4020-40	☒	TC-Coated



Needle Holder Single Action, Straight

Working/Total Length	Jaw-Ø	Shaft-Ø	Code	Locking	Tip
174 mm / 300 mm	5 mm	5 mm	FR-4021-30	☒	TC-Coated
224 mm / 350 mm	5 mm	5 mm	FR-4021-35	☒	TC-Coated
274 mm / 400 mm	5 mm	5 mm	FR-4021-40	☒	TC-Coated



Needle Holder Single Action, Curved Left

Working/Total Length	Jaw-Ø	Shaft-Ø	Code	Locking	Tip
174 mm / 300 mm	5 mm	5 mm	FR-4022-30	☒	TC-Coated
224 mm / 350 mm	5 mm	5 mm	FR-4022-35	☒	TC-Coated
274 mm / 400 mm	5 mm	5 mm	FR-4022-40	☒	TC-Coated



Needle Holder Single Action, Curved Right

Working/Total Length	Jaw-Ø	Shaft-Ø	Code	Locking	Tip
174 mm / 300 mm	5 mm	5 mm	FR-4023-30	☒	TC-Coated
224 mm / 350 mm	5 mm	5 mm	FR-4023-35	☒	TC-Coated
274 mm / 400 mm	5 mm	5 mm	FR-4023-40	☒	TC-Coated



Needle Holders

Needle Holder Single Action, Curved Right 2 x 10 mm

Working/Total Length	Jaw-Ø	Shaft-Ø	Code	Locking	Tip
174 mm / 300 mm	5 mm	5 mm	FR-4024-30	☒	TC-Coated
224 mm / 350 mm	5 mm	5 mm	FR-4024-35	☒	TC-Coated
274 mm / 400 mm	5 mm	5 mm	FR-4024-40	☒	TC-Coated

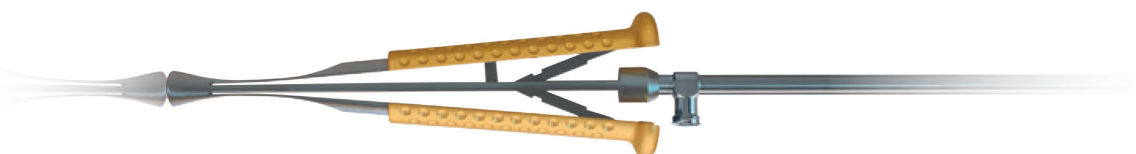
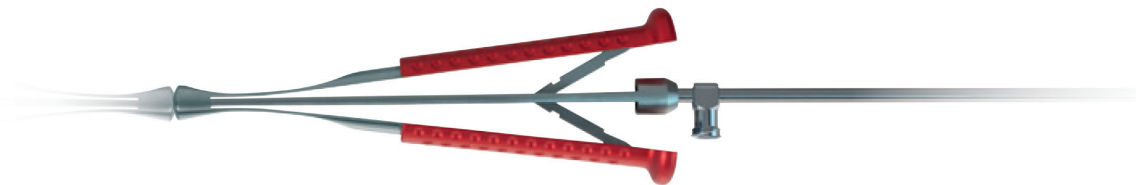
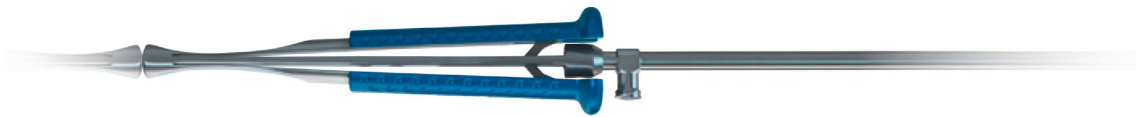

Special Instruments



Knot Pusher

Working/Total Length	Jaw-Ø	Shaft-Ø	Code	Locking	Tip
161 mm / 300 mm	3.5 mm	3.4 mm	FR-5000-30		
221 mm / 350 mm	3.5 mm	3.4 mm	FR-5000-35		
271 mm / 400 mm	3.5 mm	3.4 mm	FR-5000-40		



Knot Pusher with Lock

Working/Total Length	Jaw-Ø	Shaft-Ø	Code	Locking	Tip
161 mm / 300 mm	3.5 mm	3.4 mm	FR-5001-30	☒	
221 mm / 350 mm	3.5 mm	3.4 mm	FR-5001-35	☒	
271 mm / 400 mm	3.5 mm	3.4 mm	FR-5001-40	☒	



Knot Pusher Reverse Acting

Working/Total Length	Jaw-Ø	Shaft-Ø	Code	Locking	Tip
161 mm / 300 mm	3.5 mm	3.4 mm	FR-5002-30		
221 mm / 350 mm	3.5 mm	3.4 mm	FR-5002-35		
271 mm / 400 mm	3.5 mm	3.4 mm	FR-5002-40		



Knot Pusher

Working/Total Length	Jaw-Ø	Shaft-Ø	Code	Locking	Tip
184 mm / 300 mm	5 mm	5 mm	FR-5003-30		
234 mm / 350 mm	5 mm	5 mm	FR-5003-35		
284 mm / 400 mm	5 mm	5 mm	FR-5003-40		



Special Instruments



**Knot Pusher with Lock**

Working/Total Length	Jaw-Ø	Shaft-Ø	Code	Locking	Tip
184 mm 300 mm	5 mm	5 mm	FR-5004-30	☒	
234 mm 350 mm	5 mm	5 mm	FR-5004-35	☒	
284 mm 400 mm	5 mm	5 mm	FR-5004-40	☒	



**Knot Pusher Reverse Acting**

Working/Total Length	Jaw-Ø	Shaft-Ø	Code	Locking	Tip
184 mm 300 mm	5 mm	5 mm	FR-5005-30		
234 mm 350 mm	5 mm	5 mm	FR-5005-35		
284 mm 400 mm	5 mm	5 mm	FR-5005-40		



**Knot Pusher Short Jaw**

Working/Total Length	Jaw-Ø	Shaft-Ø	Code	Locking	Tip
184 mm 300 mm	5 mm	5 mm	FR-5006-30		
234 mm 350 mm	5 mm	5 mm	FR-5006-35		
284 mm 400 mm	5 mm	5 mm	FR-5006-40		



**Knot Pusher Short Jaw with Lock**

Working/Total Length	Jaw-Ø	Shaft-Ø	Code	Locking	Tip
184 mm 300 mm	5 mm	5 mm	FR-5007-30	☒	
234 mm 350 mm	5 mm	5 mm	FR-5007-35	☒	
284 mm 400 mm	5 mm	5 mm	FR-5007-40	☒	



Special Instruments

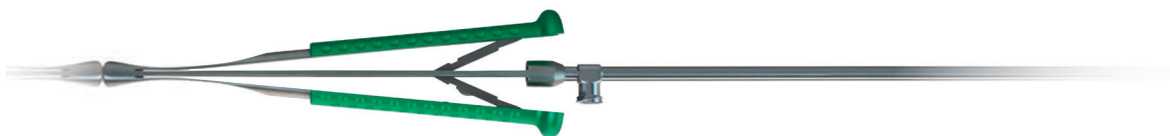

Knot Pusher Short Jaw Reverse Acting

Working/Total Length	Jaw-Ø	Shaft-Ø	Code	Locking	Tip
184 mm / 300 mm	5 mm	5 mm	FR-5008-30		
234 mm / 350 mm	5 mm	5 mm	FR-5008-35		
284 mm / 400 mm	5 mm	5 mm	FR-5008-40		



Forceps Smooth Jaw, Single Action

Working/Total Length	Jaw-Ø	Shaft-Ø	Code	Locking	Tip
184 mm / 300 mm	3.5 mm	5 mm	FR-5009-30		
234 mm / 350 mm	3.5 mm	5 mm	FR-5009-35		
284 mm / 400 mm	3.5 mm	5 mm	FR-5009-40		



Grasper Forceps Single Action, Upwards 45°, Mouse Teeth 2 x 1 mm

Working/Total Length	Jaw-Ø	Shaft-Ø	Code	Locking	Tip
161 mm / 300 mm	3.5 mm	3.4 mm	FR-5010-30		
221 mm / 350 mm	3.5 mm	3.4 mm	FR-5010-35		
271 mm / 400 mm	3.5 mm	3.4 mm	FR-5010-40		



Dissecting Forceps Double Action

Working/Total Length	Jaw-Ø	Shaft-Ø	Code	Locking	Tip
193 mm / 300 mm	5 mm	5 mm	FR-5011-30		
243 mm / 350 mm	5 mm	5 mm	FR-5011-35		
293 mm / 400 mm	5 mm	5 mm	FR-5011-40		



Special Instruments



Maryland Forceps Double Action

Working/Total Length	Jaw-Ø	Shaft-Ø	Code	Locking	Tip
184 mm / 300 mm	5 mm	5 mm	FR-5012-30		
234 mm / 350 mm	5 mm	5 mm	FR-5012-35		
284 mm / 400 mm	5 mm	5 mm	FR-5012-40		



Leaflet Forceps, Curved Slightly

Working/Total Length	Jaw-Ø	Shaft-Ø	Code	Locking	Tip
193 mm / 300 mm	5 mm	5 mm	FR-5013-30		
243 mm / 350 mm	5 mm	5 mm	FR-5013-35		
293 mm / 400 mm	5 mm	5 mm	FR-5013-40		



Leaflet Forceps, Curved Strongly

Working/Total Length	Jaw-Ø	Shaft-Ø	Code	Locking	Tip
193 mm / 300 mm	5 mm	5 mm	FR-5014-30		
243 mm / 350 mm	5 mm	5 mm	FR-5014-35		
293 mm / 400 mm	5 mm	5 mm	FR-5014-40		



Leaflet Forceps, Curved Slightly

Working/Total Length	Jaw-Ø	Shaft-Ø	Code	Locking	Tip
193 mm / 300 mm	5 mm	5 mm	FR-5015-30	☒	
243 mm / 350 mm	5 mm	5 mm	FR-5015-35	☒	
293 mm / 400 mm	5 mm	5 mm	FR-5015-40	☒	



MICS & VATS INSTRUMENTS

Special Instruments



Leaflet Forceps, Curved Strongly

Working/Total Length	Jaw-Ø	Shaft-Ø	Code	Locking	Tip
193 mm / 300 mm	5 mm	5 mm	FR-5016-30	☒	
243 mm / 350 mm	5 mm	5 mm	FR-5016-35	☒	
293 mm / 400 mm	5 mm	5 mm	FR-5016-40	☒	



Clip Forceps for Horizon Small Double Action, Yellow

Working/Total Length	Jaw-Ø	Shaft-Ø	Code	Locking	Tip
177 mm / 300 mm	5 mm	5 mm	FR-5017-30		
235 mm / 350 mm	5 mm	5 mm	FR-5017-35		
285 mm / 400 mm	5 mm	5 mm	FR-5017-40		



3 Test clips must be provided per instrument when ordering

Clip Forceps for Horizon Small Double Action, Red

Working/Total Length	Jaw-Ø	Shaft-Ø	Code	Locking	Tip
177 mm / 300 mm	5 mm	5 mm	FR-5018-30		
235 mm / 350 mm	5 mm	5 mm	FR-5018-35		
285 mm / 400 mm	5 mm	5 mm	FR-5018-40		



3 Test clips must be provided per instrument when ordering

Clip Forceps for Horizon Medium Double Action, Blue

Working/Total Length	Jaw-Ø	Shaft-Ø	Code	Locking	Tip
177 mm / 300 mm	5 mm	5 mm	FR-5019-30		
235 mm / 350 mm	5 mm	5 mm	FR-5019-35		
285 mm / 400 mm	5 mm	5 mm	FR-5019-40		



3 Test clips must be provided per instrument when ordering

Special Instruments

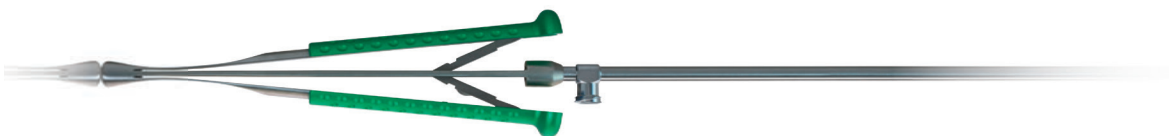

Clip Forceps for Vitalitec Small Double Action, Yellow

Working/Total Length	Jaw-Ø	Shaft-Ø	Code	Locking	Tip
177 mm / 300 mm	5 mm	5 mm	FR-5020-30		
235 mm / 350 mm	5 mm	5 mm	FR-5020-35		
285 mm / 400 mm	5 mm	5 mm	FR-5020-40		

3 Test clips must be provided per instrument when ordering



Clip Forceps for Vitalitec Medium Double Action, Blue

Working/Total Length	Jaw-Ø	Shaft-Ø	Code	Locking	Tip
177 mm / 300 mm	5 mm	5 mm	FR-5021-30		
235 mm / 350 mm	5 mm	5 mm	FR-5021-35		
285 mm / 400 mm	5 mm	5 mm	FR-5021-40		

3 Test clips must be provided per instrument when ordering



Clip Forceps for Nexus Small Double Action, Yellow

Working/Total Length	Jaw-Ø	Shaft-Ø	Code	Locking	Tip
177 mm / 300 mm	5 mm	5 mm	FR-5022-30		
235 mm / 350 mm	5 mm	5 mm	FR-5022-35		
285 mm / 400 mm	5 mm	5 mm	FR-5022-40		

3 Test clips must be provided per instrument when ordering



**Chest Tube Passers**



Description	Length	Code
Chest Tube Passers 2.8 mm	24 cm	FR-8100-24

**Chest Tube Passers**



Description	Length	Code
Chest Tube Passers 2.8 mm	36 cm	FR-8100-36





# MICS & VATS INSTRUMENTS

## MICS Instruments



## VATS Instruments



**VATS Scissors**



**Description**

Metzenbaum Scissors Slightly Curved TC 10 mm Shaft  
 Metzenbaum Scissors Slightly Curved TC 10 mm Shaft

**Total Length**

33 cm  
 37 cm

**Code**

FR-8101-33  
 FR-8101-37

**VATS Scissors**



**Description**

Metzenbaum Scissors Slightly Curved TC 10 mm Shaft  
 Metzenbaum Scissors Slightly Curved TC 10 mm Shaft

**Total Length**

32 cm  
 36 cm

**Code**

FR-8102-32  
 FR-8102-36



# MICS & VATS INSTRUMENTS

## VATS Scissors

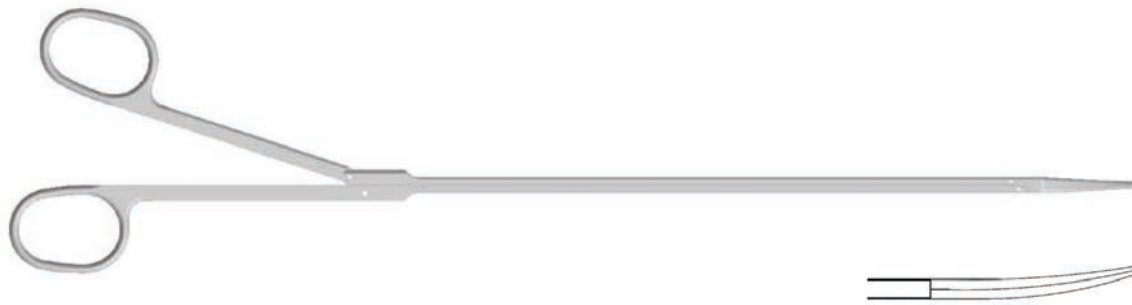

**Description**

Metzenbaum Scissors Curved Super Cut TC 5 mm Shaft

**Total Length**

36 cm

**Code**

FR-8103-36

## VATS Scissors



**Description**

Metzenbaum Fino Scissors Curved Super Cut TC 7 mm Shaft

**Total Length**

36 cm

**Code**

FR-8104-36

## VATS Scissors



**Description**

Metzenbaum Short Jaw Scissors Curved Super Cut TC 7 mm Shaft

**Total Length**

29 cm

**Code**

FR-8105-29

### VATS Scissors



Description	Total Length	Code
Metzenbaum Short Jaw Scissors Curved Super Cut TC 5 mm Shaft	29 cm	FR-8106-29
Metzenbaum Short Jaw Scissors Curved Super Cut TC 7 mm Shaft	32 cm	FR-8106-32
Metzenbaum Short Jaw Scissors Curved Super Cut TC 7 mm Shaft	36 cm	FR-8106-36

### VATS Needle Holder

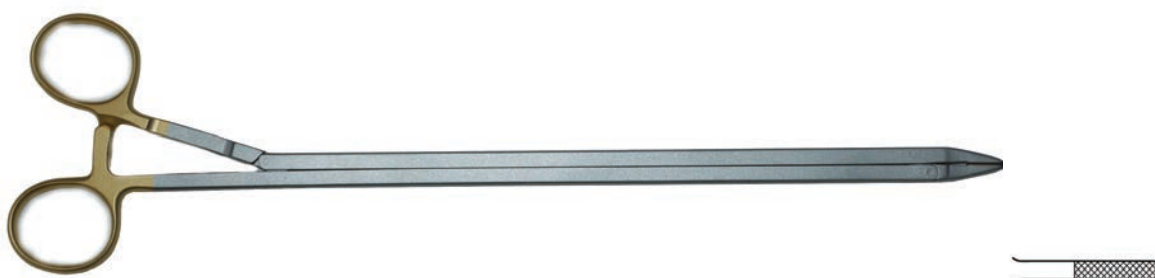

Description	Jaw	Shaft	Total Length	Code
VATS Needle Holder Straight TC	2 mm	10 mm	29 cm	FR-8107-29

### VATS Needle Holder

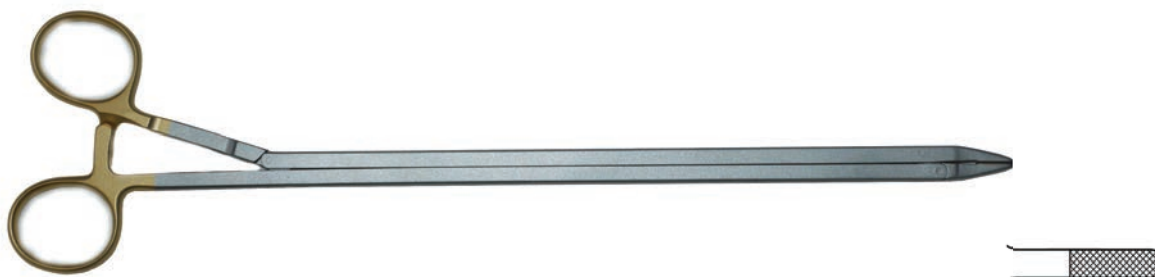

Description	Jaw	Shaft	Total Length	Code
VATS Needle Holder Straight TC	3 mm	10 mm	29 cm	FR-8108-29

VATS Needle Holder

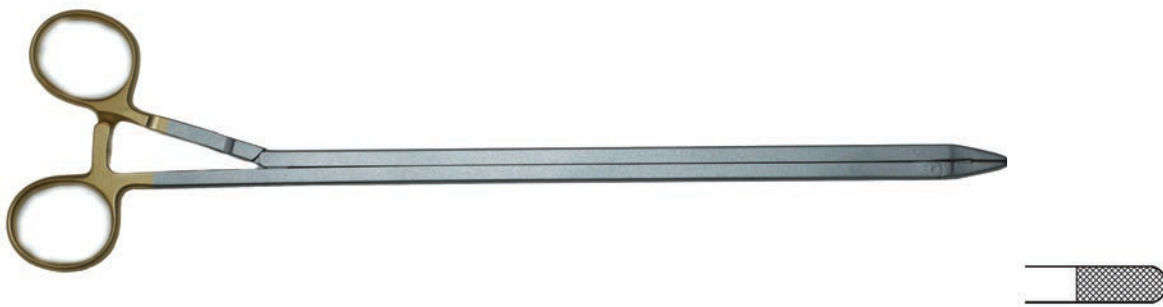

Description	Jaw	Shaft	Total Length	Code
VATS Needle Holder Straight TC	4 mm	10 mm	29 cm	FR-8110-29
VATS Needle Holder Straight TC	4 mm	7 mm	34 cm	FR-8110-34

VATS Needle Holder

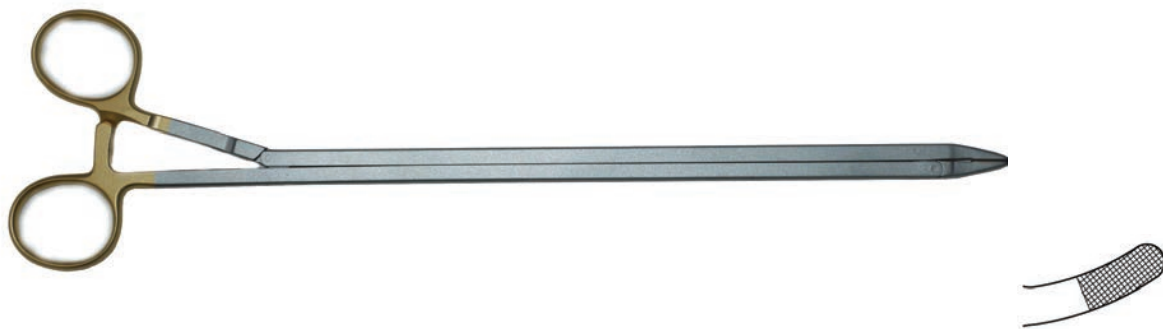

Description	Jaw	Shaft	Total Length	Code
VATS Needle Holder Curved TC	4 mm	7 mm	29 cm	FR-8111-29
VATS Needle Holder Curved TC	4 mm	7 mm	34 cm	FR-8111-34

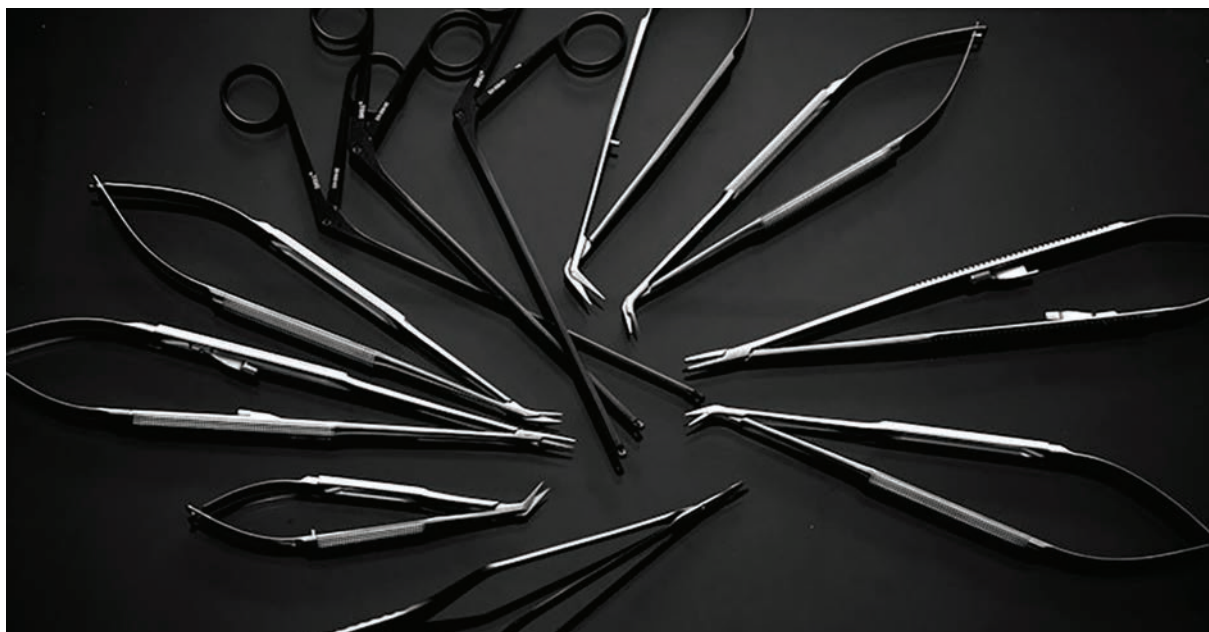

**VATS DeBakey Clamp**

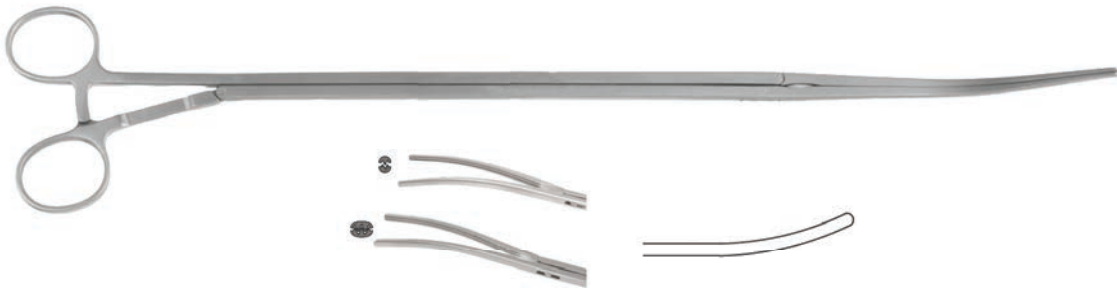

**Description**

VATS DeBakey Clamp, 1 x 2 DeBakey  
 VATS DeBakey Clamp, 2 x 3 DeBakey

**Jaw**

82 mm  
 82 mm

**Shaft**

10 mm  
 10 mm

**Total Length**

29 cm  
 29 cm

**Code**

FR-8301-29  
 FR-8302-29

**VATS DeBakey Clamp**

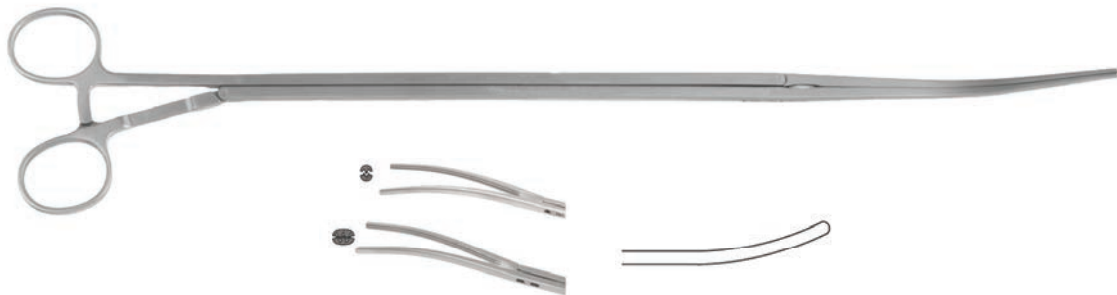

**Description**

VATS DeBakey Clamp, 1 x 2 DeBakey  
 VATS DeBakey Clamp, 2 x 3 DeBakey

**Jaw**

62 mm  
 62 mm

**Shaft**

10 mm  
 10 mm

**Total Length**

33 cm  
 29 cm

**Code**

FR-8303-33  
 FR-8304-29

**VATS DeBakey Clamp**

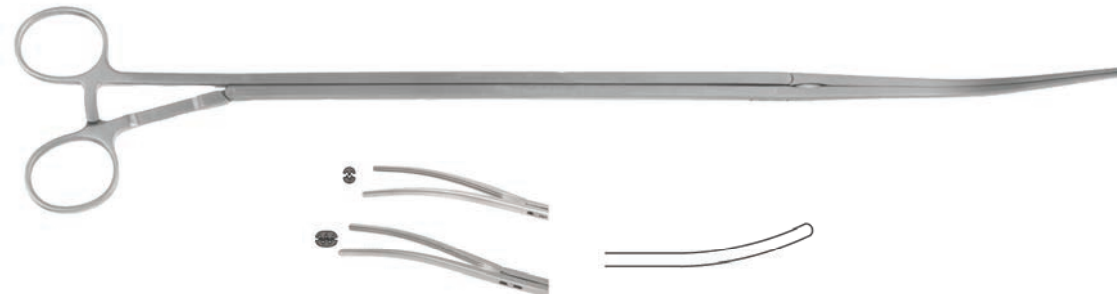

**Description**

VATS DeBakey Clamp, 1 x 2 DeBakey  
 VATS DeBakey Clamp, 2 x 3 DeBakey

**Jaw**

92 mm  
 92 mm

**Shaft**

10 mm  
 10 mm

**Total Length**

36 cm  
 36 cm

**Code**

FR-8305-36  
 FR-8306-36

VATS DeBakey Clamp

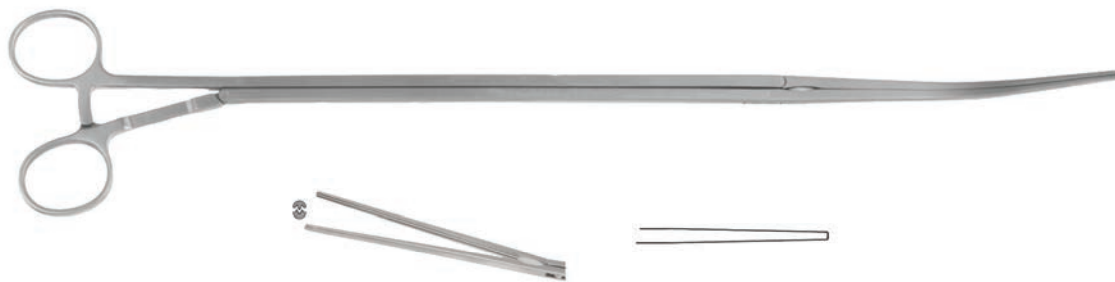

Description	Jaw	Shaft	Total Length	Code
VATS DeBakey Clamp Straight	110 mm	10 mm	38 cm	FR-9301-38

VATS DeBakey Clamp

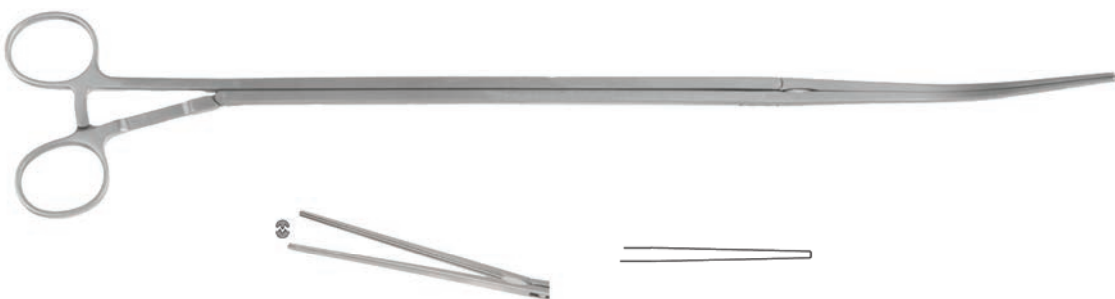

Description	Jaw	Shaft	Total Length	Code
VATS DeBakey Clamp Curved	110 mm	10 mm	38 cm	FR-9302-38

VATS DeBakey Clamp

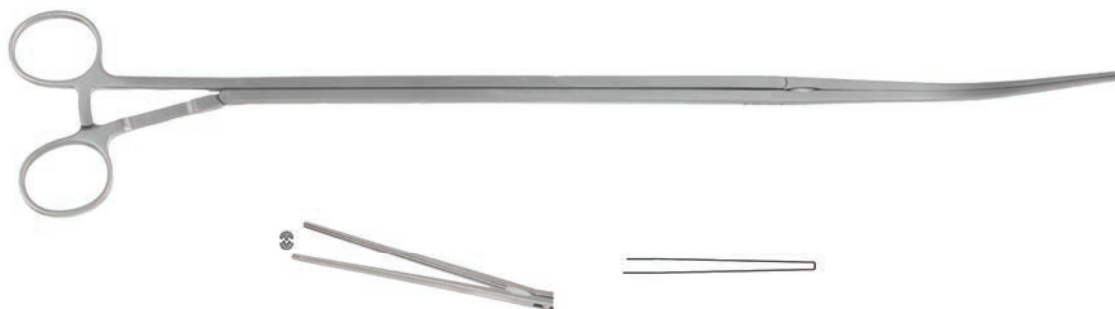

Description	Jaw	Shaft	Total Length	Code
VATS DeBakey Clamp Fully Curved	105 mm	10 mm	37 cm	FR-9303-37

VATS Harken and Satinsky Clamp

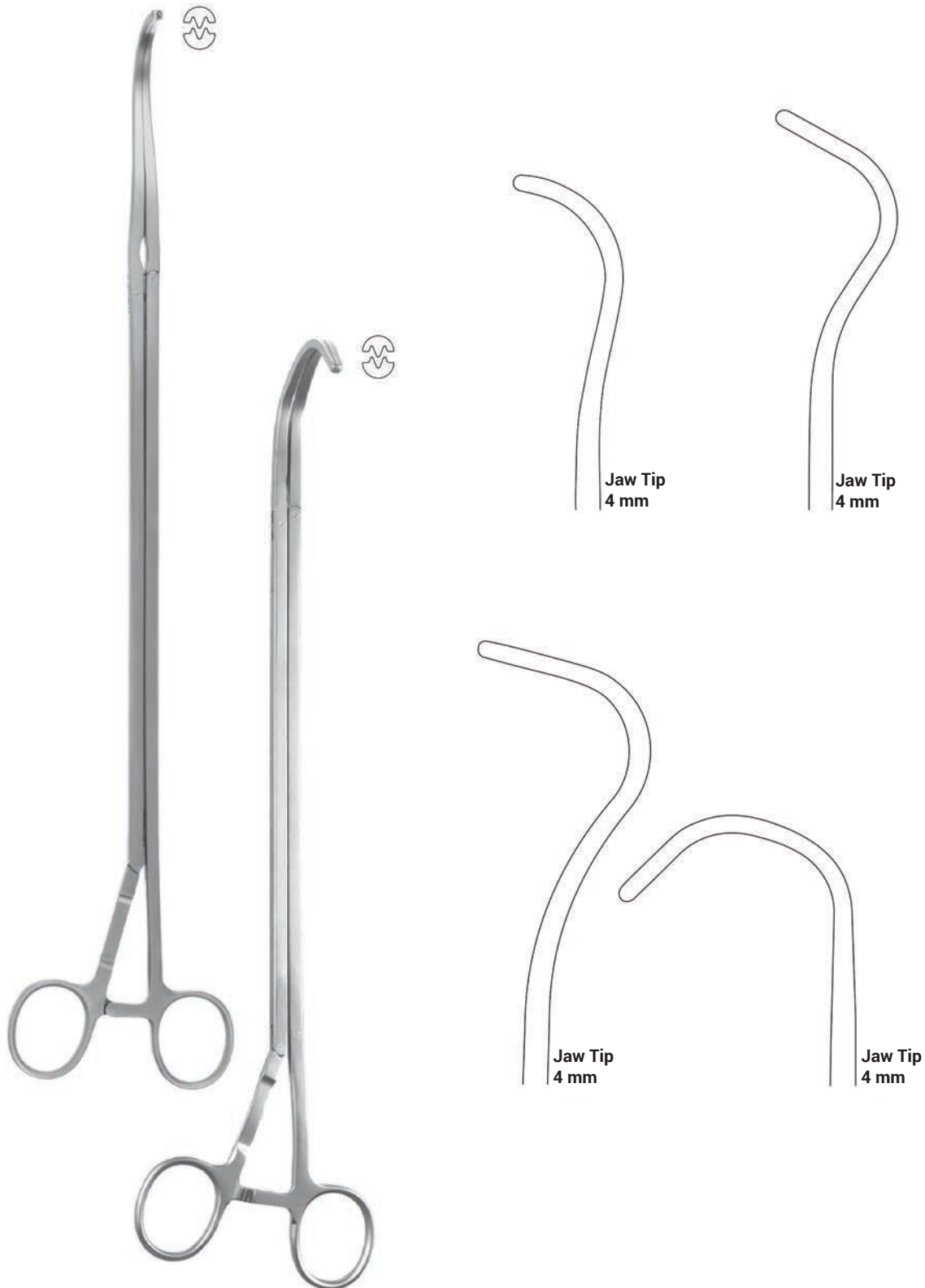

Description	Shaft with Ratchet	Total Length	Code
VATS Harken DeBakey Clamp Strongly Curved	10 mm	35 cm	FR-9304-35
VATS Harken DeBakey Clamp Strongly Curved	10 mm	29 cm	FR-9305-29

VATS Harken and Satinsky Clamp

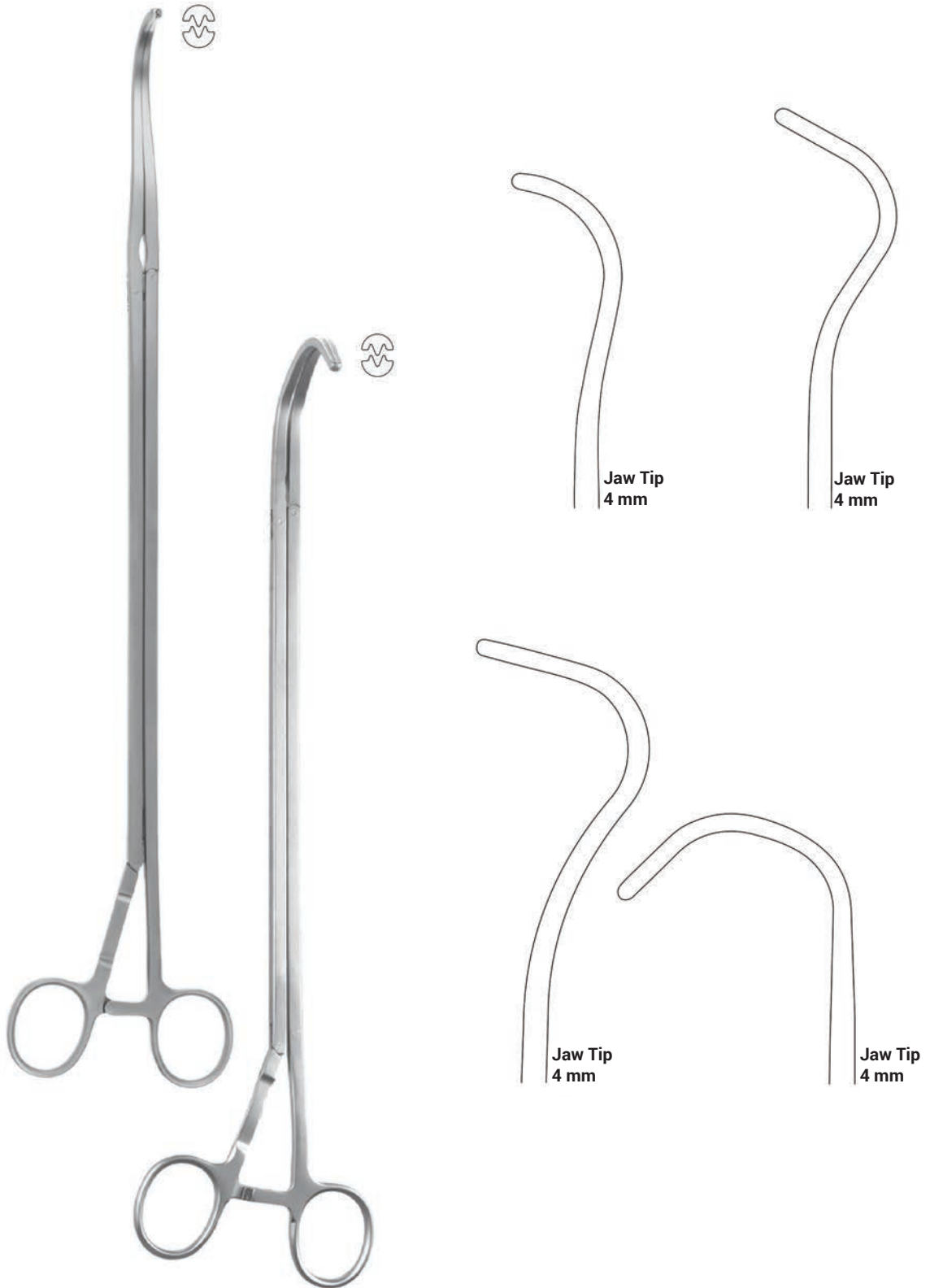

Description	Shaft with Ratchet	Total Length	Code
VATS Harken DeBakey Clamp Slightly Curved	10 mm	35 cm	FR-9306-35
VATS Harken DeBakey Clamp Slightly Curved	10 mm	35 cm	FR-9307-35

VATS Harken and Satinsky Clamp

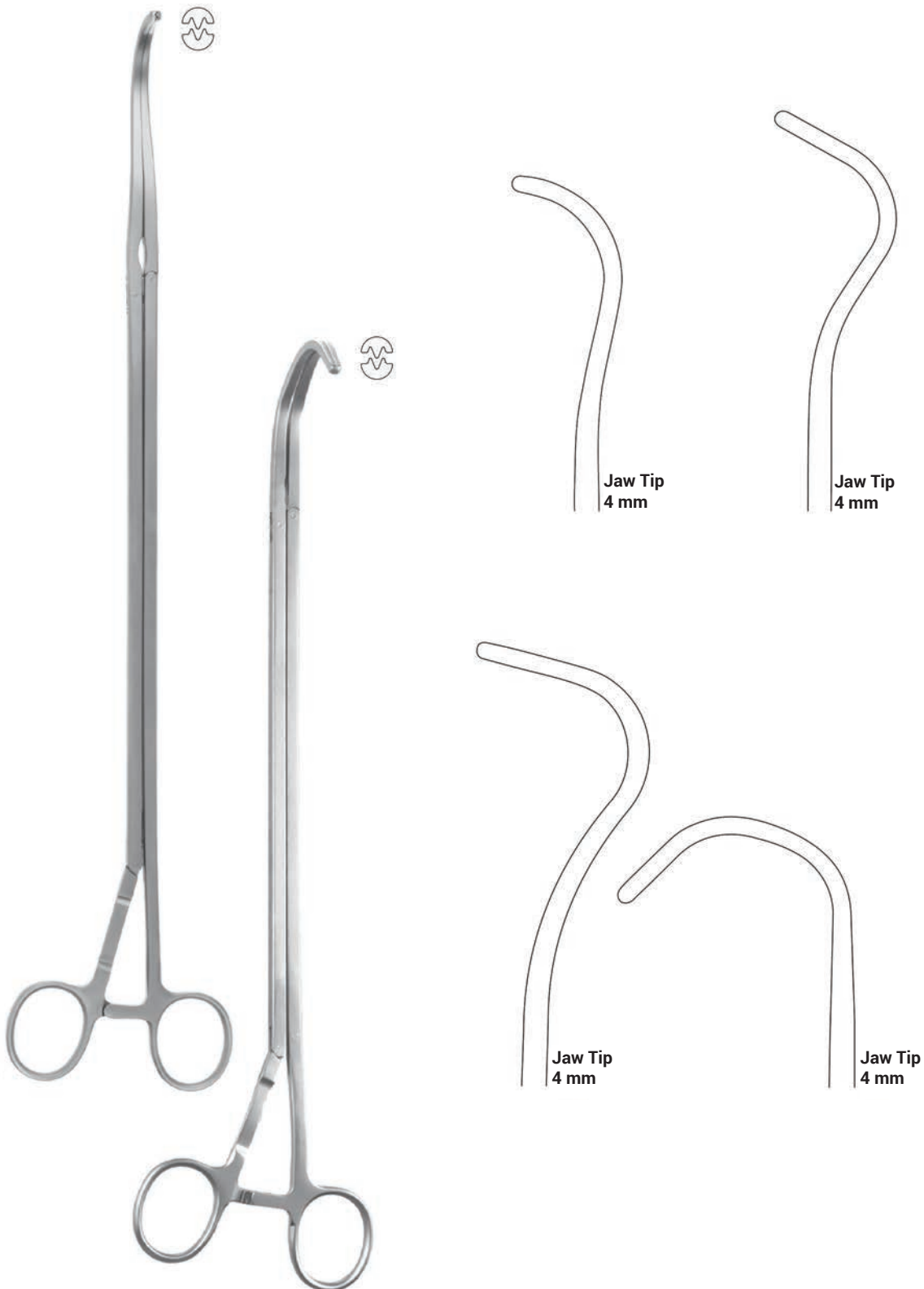

MICS & VATS INSTRUMENTS

**Description**

VATS Harken DeBakey Clamp  
Strongly Curved

**Shaft with Ratchet**

10 mm

**Total Length**

36 cm

**Code**

FR-9308-36

# MICS & VATS INSTRUMENTS

## VATS Harken and Satinsky Clamp

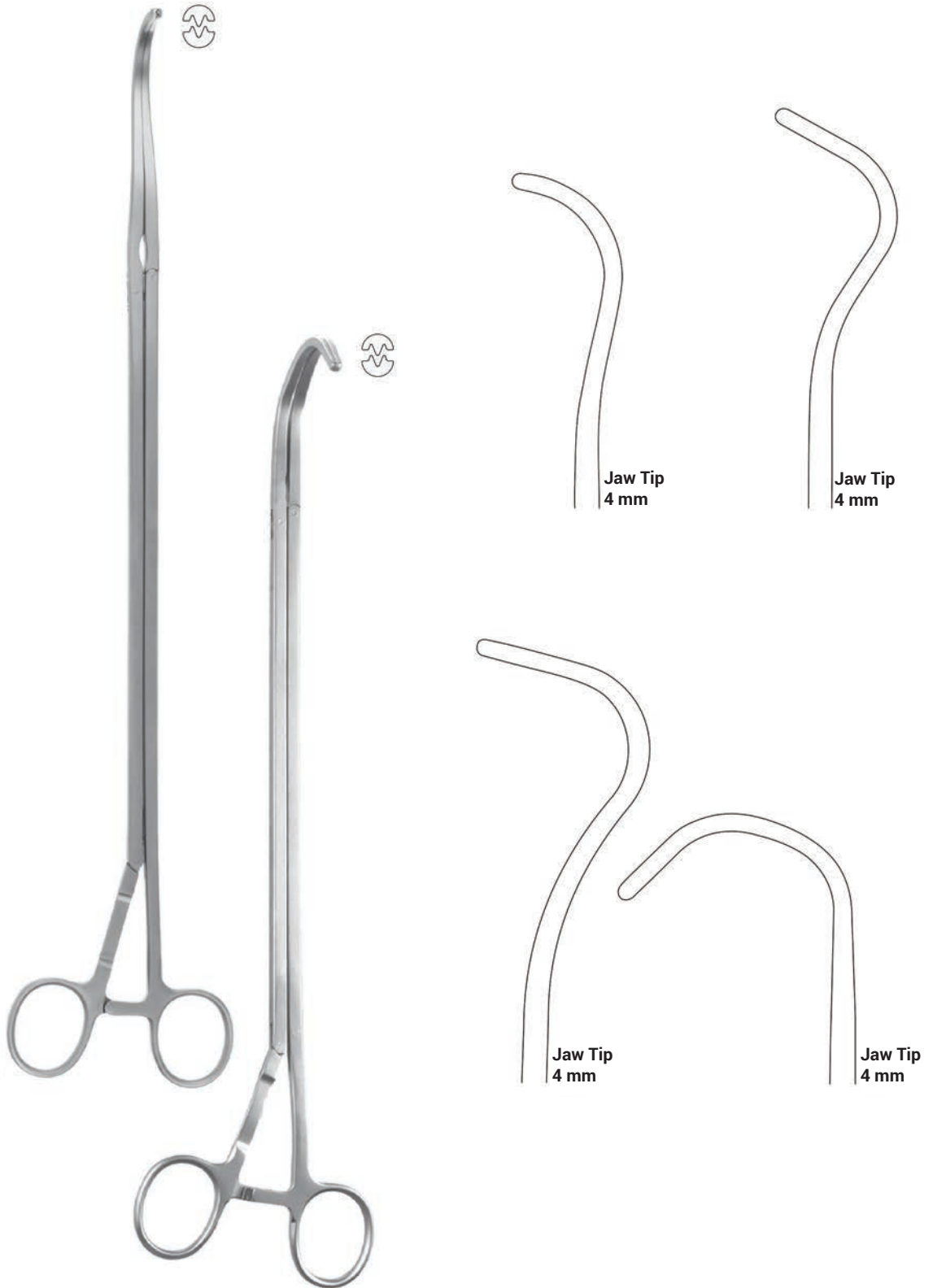

Description	Jaw	Shaft with Ratchet	Total Length	Code
VATS Harken DeBakey Clamp Satinsky	3 mm	10 mm	32 cm	FR-9309-32

VATS Foerster Lung Grasping Clamp

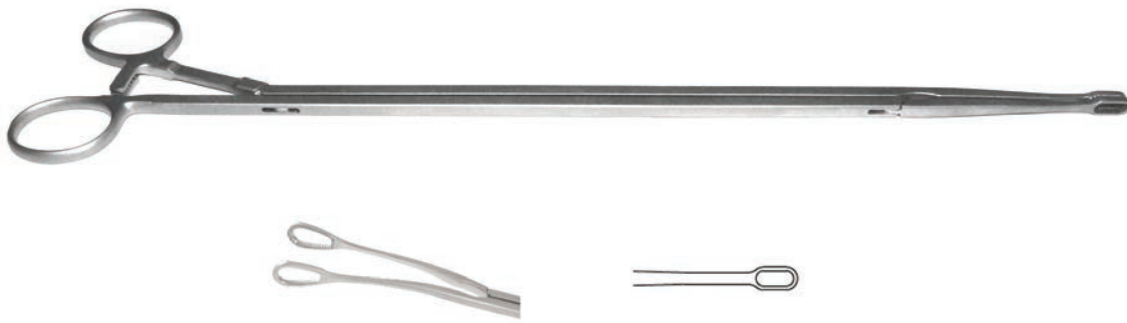

Description	Jaw	Shaft with Ratchet	Total Length	Code
Foerster Lung Grasping Forceps Straight	6 mm	5 mm	34 cm	FR-9312-34
Foerster Lung Grasping Forceps Straight	10 mm	6 mm	34 cm	FR-9313-34



VATS Foerster Lung Grasping Clamp



Description	Jaw	Shaft with Ratchet	Total Length	Code
Foerster Lung Grasping Forceps Curved	7 mm	6 mm	34 cm	FR-9314-34
Foerster Lung Grasping Forceps Curved	10 mm	6 mm	34 cm	FR-9315-34

VATS Foerster Lung Grasping Clamp



Description	Jaw	Shaft with Ratchet	Total Length	Code
Foerster Lung Grasping Forceps Curved	10 mm	7 mm	34 cm	FR-9316-34

VATS Foerster Lung Grasping Clamp



Description	Jaw	Shaft with Ratchet	Total Length	Code
Foerster Lung Grasping Forceps Curved	10 mm	10 mm	35 cm	FR-9317-35

**VATS Foerster Lung Grasping Clamp**

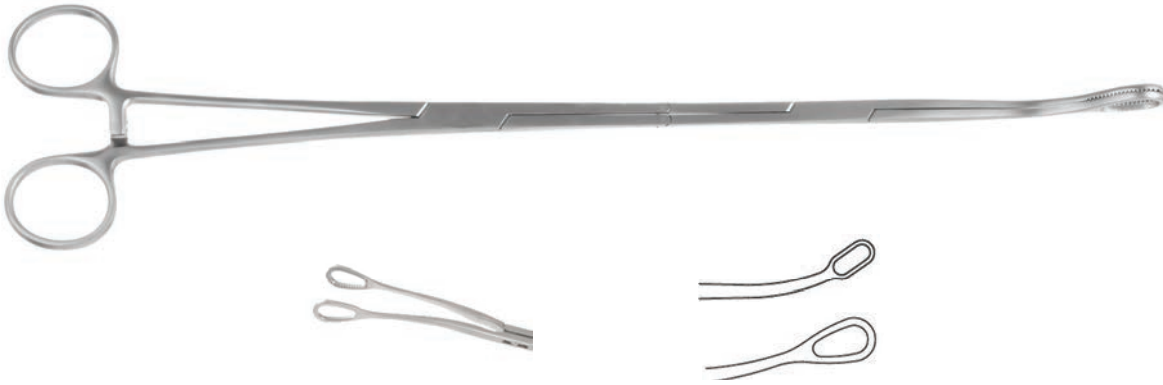

Description	Jaw	Shaft with Ratchet	Total Length	Code
Foerster Lung Grasping Forceps Curved	13 mm	10 mm	35 cm	FR-9318-35

**VATS Foerster Lung Grasping Clamp**

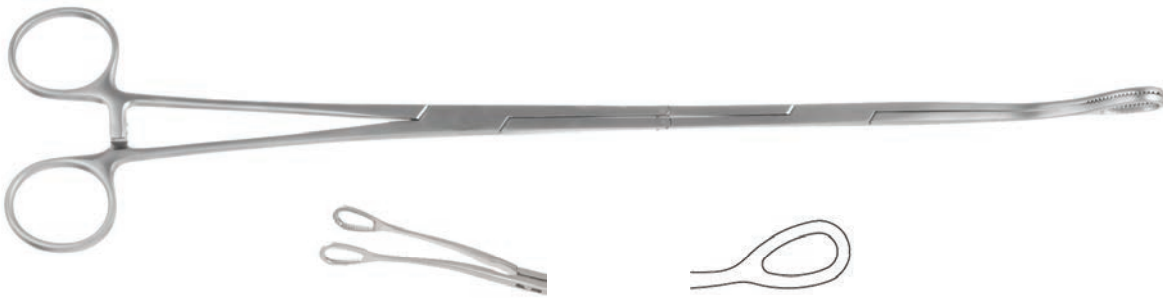

Description	Jaw	Shaft with Ratchet	Total Length	Code
Foerster Lung Grasping Forceps Curved	20 mm	10 mm	35 cm	FR-9319-35

**VATS Dissector Clamp**

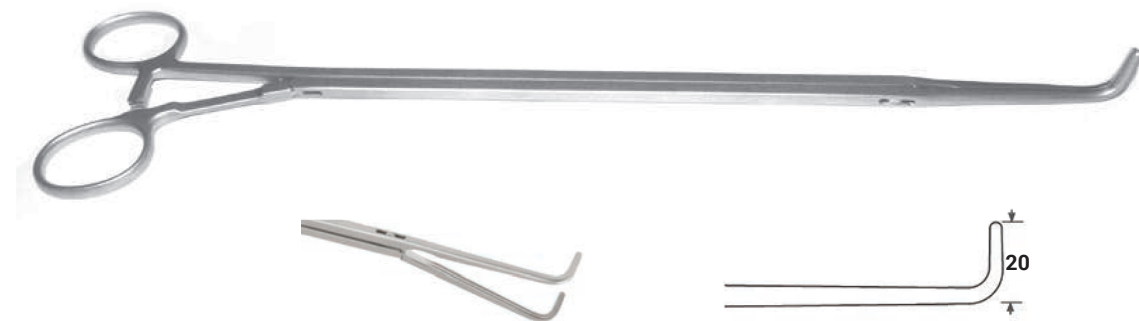

Description	Jaw	Shaft with Ratchet	Total Length	Code
VATS DeBakey 90 Degree Angle Clamp	20 mm	10 mm	33 cm	FR-9320-33

VATS Dissector Clamp

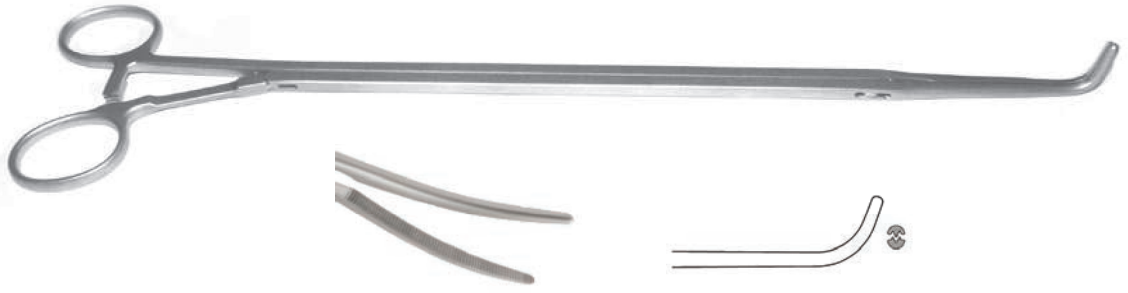

Description	Shaft with Ratchet	Total Length	Code
VATS Dennis DeBakey Clamp Curved	10 mm	33 cm	FR-9321-33

VATS Dissector Clamp

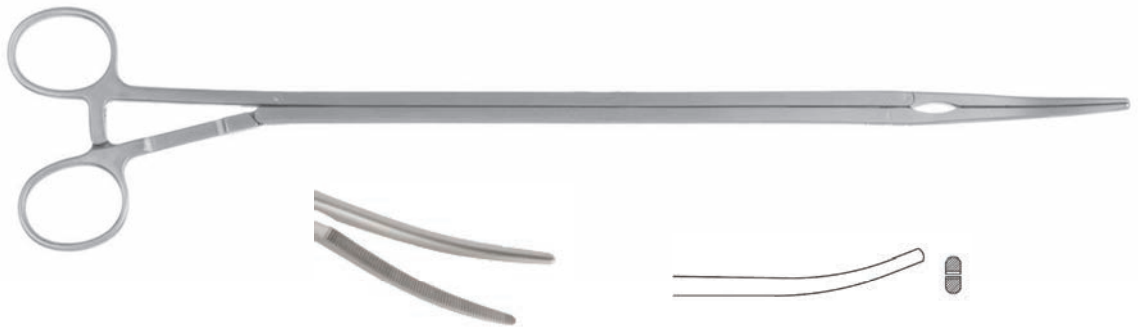

Description	Shaft with Ratchet	Total Length	Code
VATS Dennis DeBakey Clamp Curved	7 mm	33 cm	FR-9322-33

VATS Dissector Clamp



Description	Jaw	Shaft with Ratchet	Total Length	Code
VATS Glasmann Allis Clamp Curved	8.2 mm	10 mm	34 cm	FR-9323-34



VATS Dissector Clamp



Description	Jaw	Shaft with Ratchet	Total Length	Code
VATS Glasmann Allis Clamp Curved	7.2 mm	10 mm	34 cm	FR-9324-34

VATS Duval Lung Grasping Clamp



Description	Jaw	Shaft with Ratchet	Total Length	Code
Duval Lung Grasping Forceps	14 mm	10 mm	33 cm	FR-9310-33

VATS Duval Lung Grasping Clamp

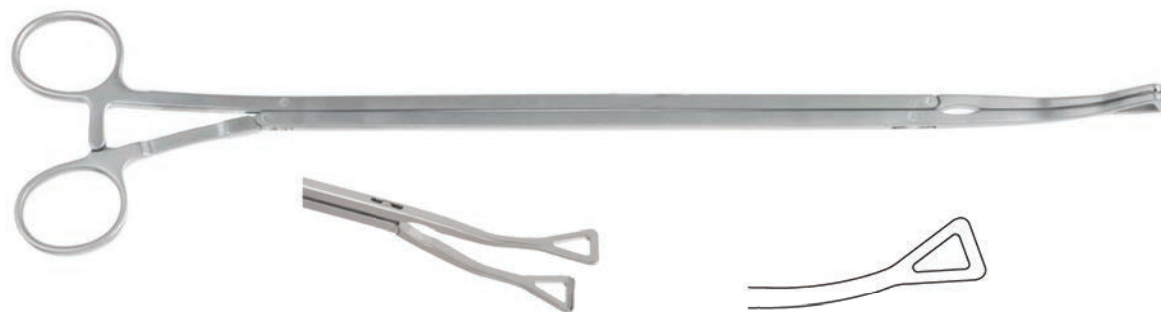

Description	Jaw	Shaft with Ratchet	Total Length	Code
Duval Lung Grasping Forceps	20 mm	10 mm	33 cm	FR-9311-33

**Valve Extra Long Rongeurs**

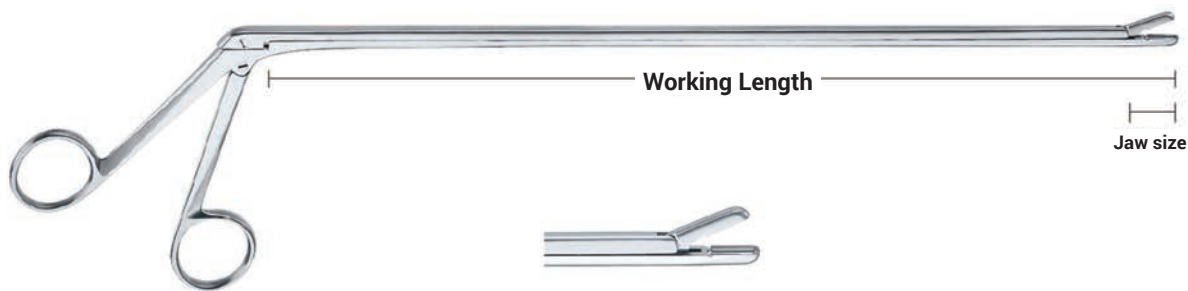

Description	Jaw	Total Length	Code
Valve Extra Long Rongeur	3 x 10 mm	33 cm	FR-9901-33

**Valve Extra Long Rongeurs**

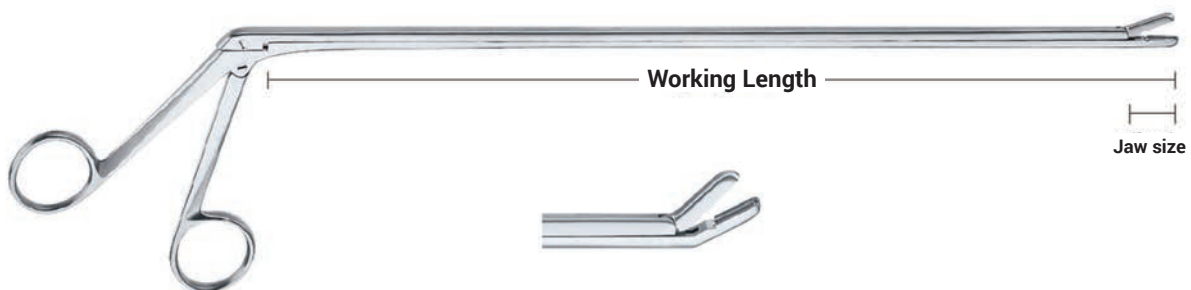

Description	Jaw	Total Length	Code
Valve Extra Long Rongeur Curved Upwards	3 x 10 mm	33 cm	FR-9902-33

**Dissector Sliding Clamp**

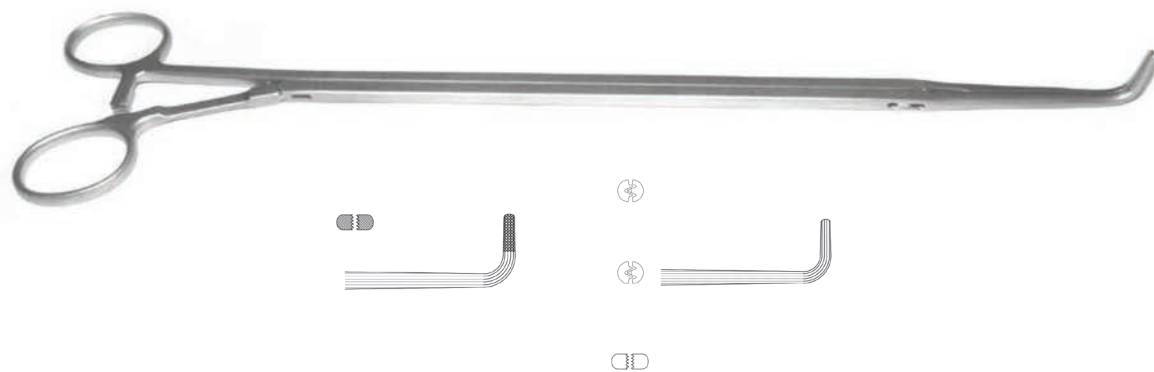

Description	Shaft with Ratchet	Working Length	Total Length	Code
Dissector Sliding Clamp	10 mm	24 cm	33 cm	FR-9903-33
Dissector Sliding Clamp	10 mm	25 cm	33 cm	FR-9904-33
Dissector Sliding Clamp	10 mm	25 cm	34 cm	FR-9905-34

**Dissector Sliding Clamp**

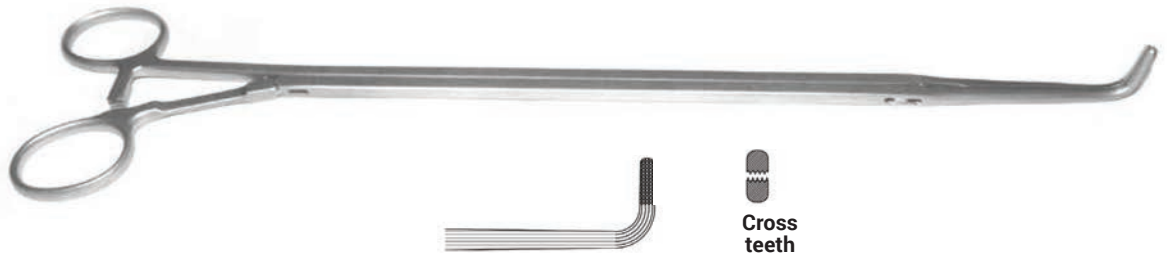

Description	Shaft without Ratchet	Working Length	Total Length	Code
Dissector Sliding Clamp	10 mm	25 cm	34 cm	FR-9906-34

**Dissector Sliding Clamp | DeBakey & Dennis**

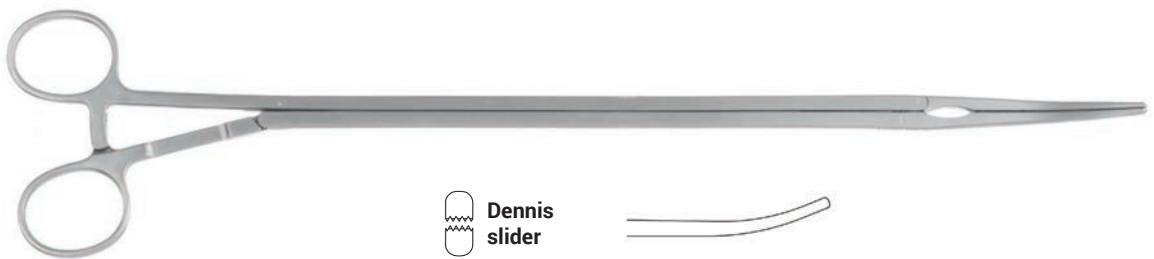

Description	Jaw	Shaft with Ratchet	Working Length	Total Length	Code
Dennis Slider	65 mm	10 mm	24 cm	33 cm	FR-9907-33
Dennis Slider w/o Ratchet	65 mm	10 mm	24 cm	33 cm	FR-9908-33

**Dissector Sliding Clamp | DeBakey & Dennis**

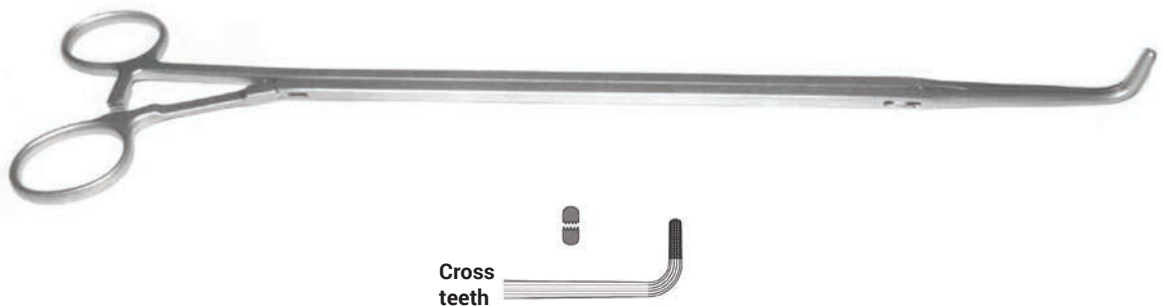

Description	Jaw	Shaft with Ratchet	Working Length	Total Length	Code
Dissector DeBakey Slider	65 mm	10 mm	24 cm	33 cm	FR-9909-33
Dissector DeBakey Slider w/o Ratchet		5 mm	19 cm	29 cm	FR-9910-29

**Sliding Scissors Super Cut**



Description	Jaw	Without Ratchet	Working Length	Total Length	Code
Sliding Scissors	55 mm	10 mm	25 cm	33 cm	FR-9911-33
Sliding Scissors	55 mm	10 mm	25 cm	36 cm	FR-9912-36

**Sliding Scissors Super Cut**



Description	Jaw	Without Ratchet	Working Length	Total Length	Code
Sliding Scissors	35 mm	7 mm	19 cm	29 cm	FR-9913-29
Sliding Scissors	35 mm	10 mm	25 cm	36 cm	FR-9914-36
Sliding Scissors	35 mm	10 mm	19 cm	29 cm	FR-9915-29

**Sliding Scissors Super Cut**



Description	Jaw	Without Ratchet	Working Length	Total Length	Code
Sliding Scissors	35 mm	5 mm	23 cm	35 cm	FR-9916-35
Sliding Scissors	35 mm	5 mm	21 cm	32 cm	FR-9917-32
Sliding Scissors	30 mm	5 mm	19 cm	29 cm	FR-9918-29
Sliding Scissors	12 mm	7 mm	27 cm	38 cm	FR-9919-38

**Double Action Grasper Clamp Hallmann**



Description	Jaw	Shaft with Ratchet	Working Length	Total Length	Code
Double Action Grasper Clamp Hallmann, Cross Teeth	8 mm		15.1 cm	34 cm	FR-9920-34
Double Action Grasper Clamp Hallmann, Cross Teeth	8 mm		16.8 cm	40 cm	FR-9921-40

**Double Action Grasper Clamp Hallmann**



Description	Jaw	Shaft with Ratchet	Working length	Total Length	Code
Double Action Grasper Clamp Hallmann, Cross Teeth	8 mm		15.1 cm	34 cm	FR-9922-34
Double Action Grasper Clamp Hallmann, Ø15 mm	8 mm		15.2 cm	38 cm	FR-9923-38

**Double Action Scissors**



Description	Jaw	Without Ratchet	Working Length	Total Length	Code
Double Action Scissors	73 mm	10 mm	21.4 cm	32 cm	FR-9924-32
Double Action Scissors	73 mm	10 mm	21.4 cm	36 cm	FR-9925-36

**Double Action Scissors**



Description	Jaw	Without Ratchet	Working Length	Total Length	Code
Double Action Scissors	67 mm	10 mm	20.8 cm	32 cm	FR-9926-32
Double Action Scissors	67 mm	10 mm	20.8 cm	36 cm	FR-9927-36

**D'Amico Biopsy Forceps**

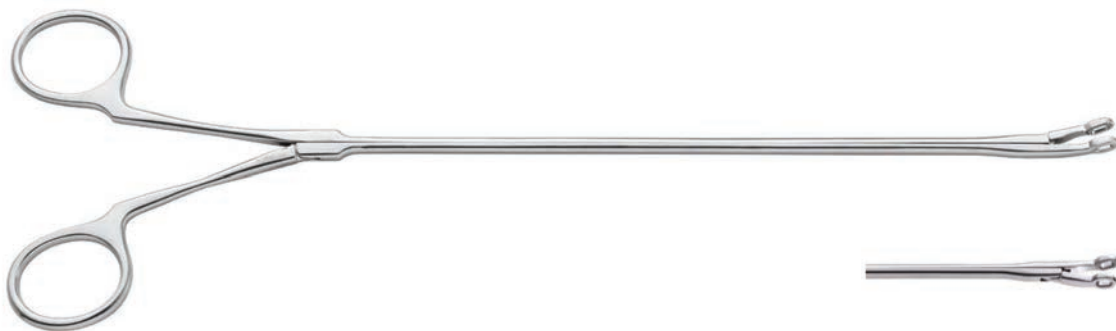

Description	Shaft Thickness	Working Length	Total Length	Code
6 mm Width Oval Ring Jaws Curved with Ratchet	5 mm Tapered to 7 mm	23 cm	33 cm	FR-9928-33

**D'Amico Biopsy Forceps**

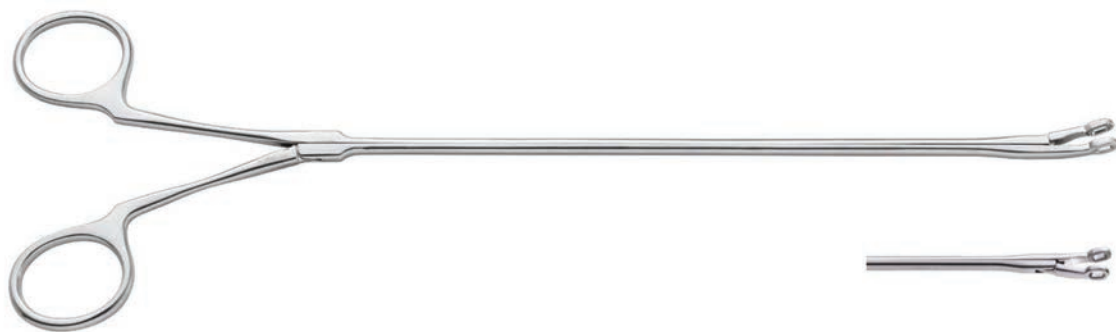

Description	Shaft Thickness	Working Length	Total Length	Code
7 mm Width Oval Ring Jaws Curved with Ratchet	5 mm Tapered to 7 mm	23 cm	33 cm	FR-9930-33

**D'Amico Mediastinoscopy Forceps**



Description	Shaft Thickness	Working Length	Total Length	Code
6 mm Width Oval Ring Jaws Curved with Ratchet	7 mm	28 cm	38 cm	FR-9932-38
6 mm Width Oval Ring Jaws Curved without Ratchet	7 mm	28 cm	38 cm	FR-9933-38

**D'Amico Mediastinoscopy Forceps**



Description	Shaft Thickness	Working Length	Total Length	Code
7 mm Width Oval Ring Jaws Curved with Ratchet	7 mm	28 cm	38 cm	FR-9934-38
7 mm Width Oval Ring Jaws Curved without Ratchet	7 mm	28 cm	38 cm	FR-9935-38

**Gonzalez-Rivas Lung Grasping Clamp**

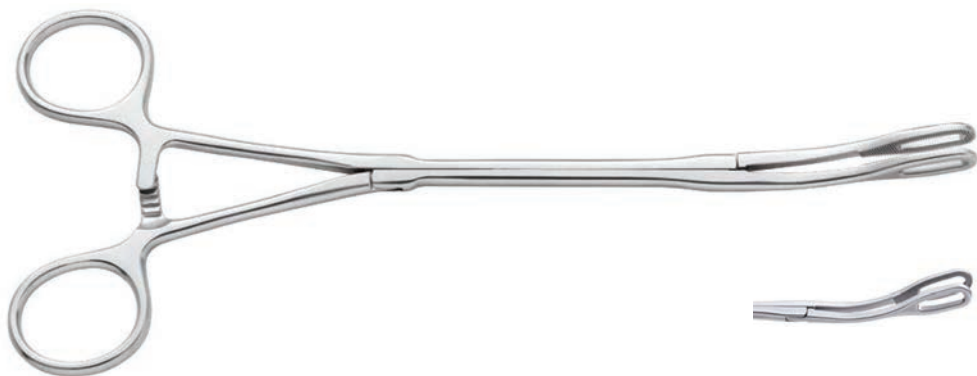

Description	Shaft Thickness	Working Length	Total Length	Code
High Tension Curved Left 20 mm Oval Ring Jaws with Ratchet	7 mm Tapered to 10 mm	15 cm	25 cm	FR-9936-25

**Foerster Lung Grasping Clamp**

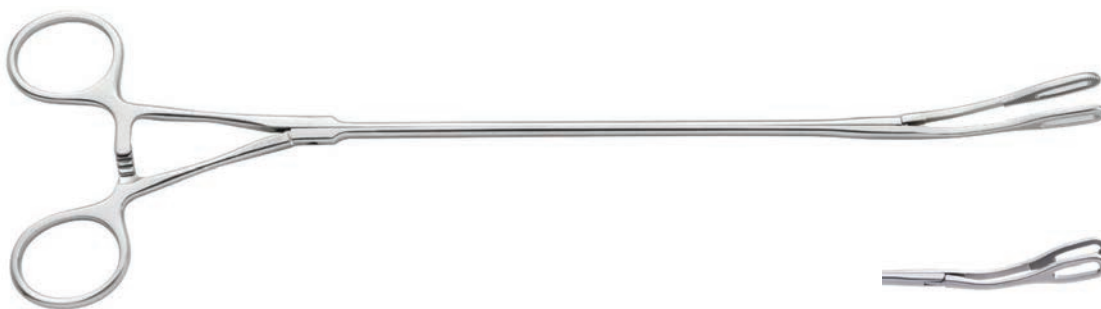

**Description**

Curved Left 20 mm Oval Ring  
Jaws with Ratchet

**Shaft  
Thickness**

5 mm Tapered to 7 mm

**Working  
Length**

24 cm

**Total  
Length**

34 cm

**Code**

FR-9937-34

**Foerster Lung Grasping Clamp**



**Description**

Curved Right Jaws (Left-Hand Style)  
12 mm Oval Ring with Ratchet 7 mm

**Shaft  
Thickness**

19 cm

**Working  
Length**

29 cm

**Total  
Length**

FR-9939-29

Curved Left Jaws  
12 mm Oval Ring with Ratchet 7 mm

19 cm

29 cm

FR-9940-29

**Foerster Lung Grasping Clamp**



**Description**

Curved Left Jaws  
12 mm Oval Ring with Ratchet

**Shaft  
Thickness**

7 mm

**Working  
Length**

24 cm

**Total  
Length**

34 cm

**Code**

FR-9941-34

**Node Grasping Clamp**



Description	Shaft Thickness	Working Length	Total Length	Code
Straight Jaws 11 mm With Ratchet	5 mm	23 cm	33 cm	FR-9952-33
Curved Jaws 11 mm With Ratchet	5 mm	23 cm	33 cm	FR-9953-33
Curved Jaws 11 mm Without Ratchet	5 mm	23 cm	33 cm	FR-9954-33

**Node Grasping Clamp**



Description	Shaft Thickness	Working Length	Total Length	Code
Curved Jaws 11 mm With Ratchet	5 mm Tapered to 7 mm	32 cm	42 cm	FR-9955-42
Curved Jaws 11 mm Without Ratchet	5 mm Tapered to 7 mm	32 cm	42 cm	FR-9956-42

**Khan Decortication Grasper**

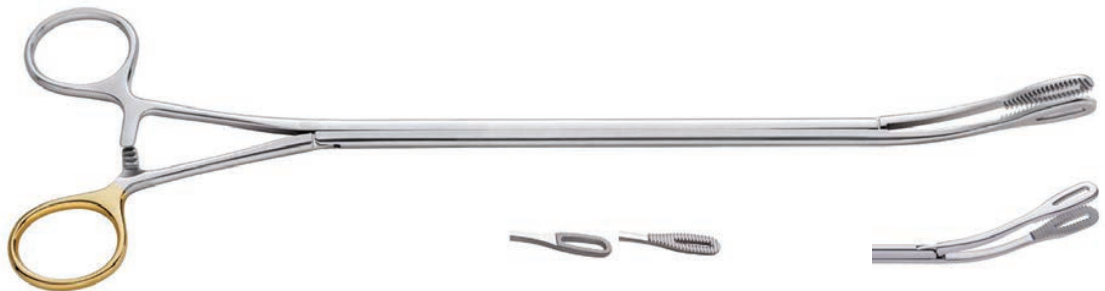

Description	Shaft Thickness	Working Length	Total Length	Code
Enhanced Serrations 20 mm Left Curved Jaws with Ratchet	10 mm	24 cm	34 cm	FR-9957-34

**Gonzalez-Rivas Dissector**

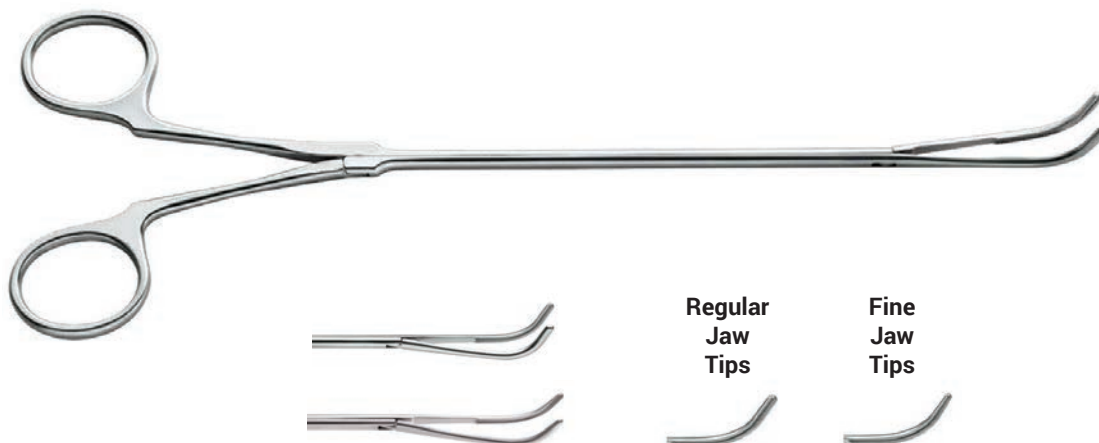

Description	Shaft Thickness	Working Length	Total Length	Code
Mixer-style 1 x 2 DeBakey Jaws with Ratchet	5 mm	19 cm	29 cm	FR-9958-29
Mixer-style 1 x 2 DeBakey Jaws without Ratchet	5 mm	19 cm	29 cm	FR-9959-29
Mixer-style 1 x 2 DeBakey Jaws Fine Tips with Ratchet	5 mm	19 cm	29 cm	FR-9960-29
Mixer-style 1 x 2 DeBakey Jaws Fine Tips without Ratchet	5 mm	19 cm	29 cm	FR-9961-29

**Gonzalez-Rivas Dissector**

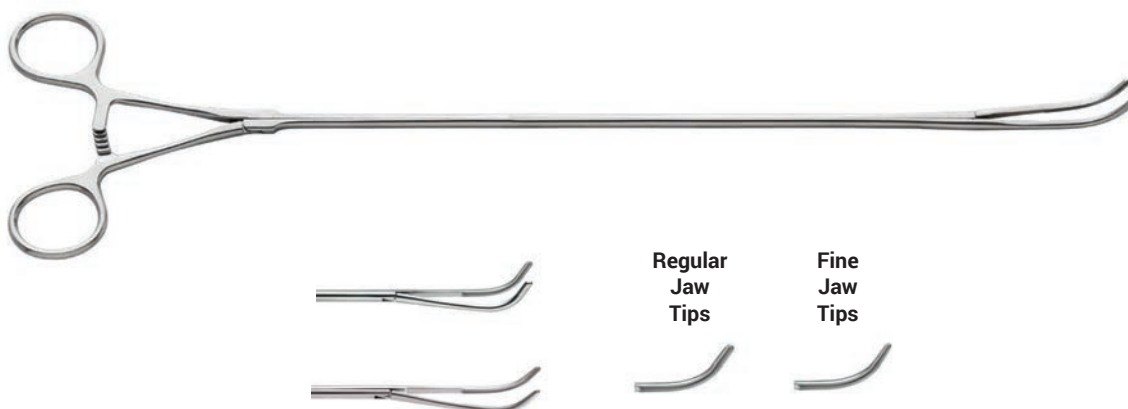

Description	Shaft Thickness	Working Length	Total Length	Code
Mixer-style 1 x 2 DeBakey Jaws with Ratchet	5 mm Tapered to 7 mm	24 cm	34 cm	FR-9962-34
Mixer-style 1 x 2 DeBakey Jaws without Ratchet	5 mm Tapered to 7 mm	24 cm	34 cm	FR-9963-34

**Gonzalez-Rivas Dissector**

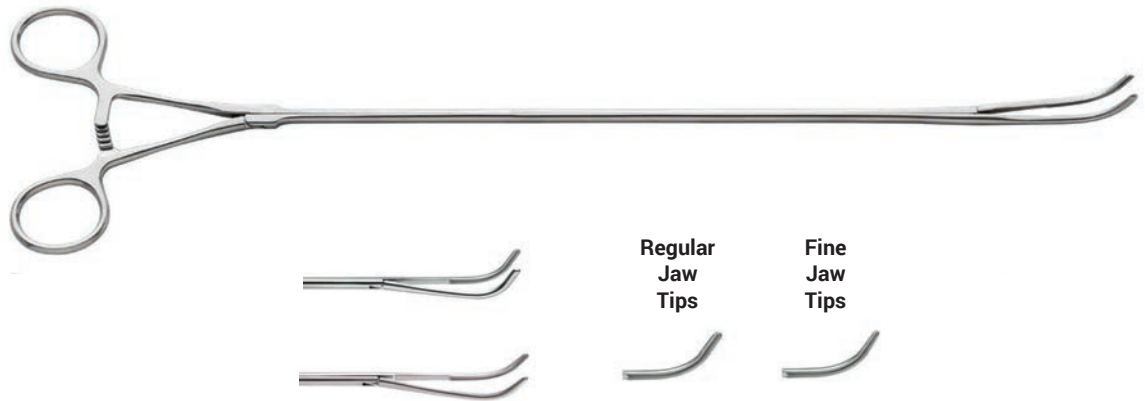

Description	Shaft Thickness	Working Length	Total Length	Code
Mixer-style 1 x 2 DeBakey Jaws with Ratchet	5 mm Tapered to 7 mm	32 cm	42 cm	FR-9964-42
Mixer-style 1 x 2 DeBakey Jaws without Ratchet	5 mm Tapered to 7 mm	32 cm	42 cm	FR-9965-42

**Snake Dissector Small**

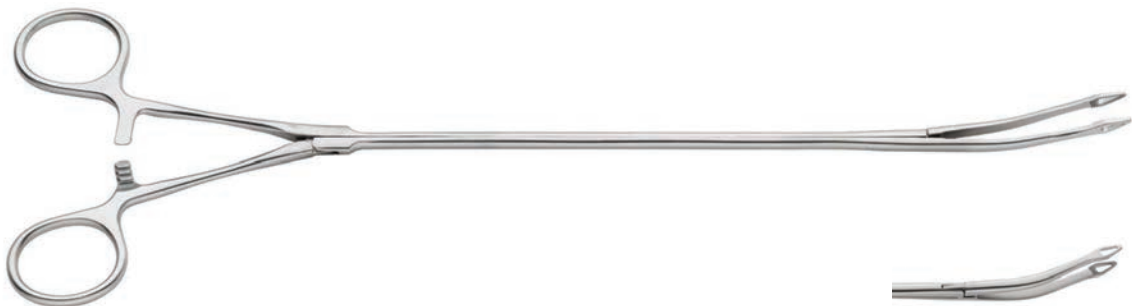

Description	Shaft Thickness	Working Length	Total Length	Code
Curved Dissector Jaws with Ratchet	5 mm Tapered to 7 mm	24 cm	34 cm	FR-9966-34
Curved Dissector Jaws without Ratchet	5 mm Tapered to 7 mm	24 cm	34 cm	FR-9967-34



### Snake Dissector Large



Description	Shaft Thickness	Working Length	Total Length	Code
Curved Dissector Jaws with Ratchet	5 mm Tapered to 7 mm	24 cm	34 cm	FR-9968-34
Curved Dissector Jaws without Ratchet	5 mm Tapered to 7 mm	24 cm	34 cm	FR-9969-34

### Dennis Dissector



Description	Shaft Thickness	Working Length	Total Length	Code
Curved Left Jaws Serrated Jaws with Ratchet	7 mm	23 cm	34 cm	FR-9970-34
Curved Left Jaws Serrated Jaws without Ratchet	7 mm	23 cm	34 cm	FR-9971-34

### Dennis Dissector



Description	Shaft Thickness	Working Length	Total Length	Code
Curved Left Jaws Serrated Jaws with Ratchet	5 mm	32 cm	42 cm	FR-9972-42
Curved Left Jaws Serrated Jaws without Ratchet	5 mm	32 cm	42 cm	FR-9973-42

**Harken Clamps**

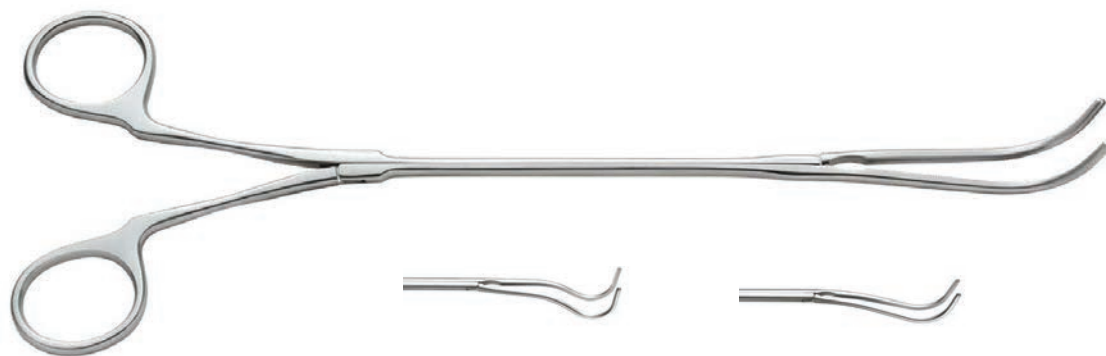

Description	Shaft Thickness	Working Length	Total Length	Code
Harken 1: 7.5 cm Tapered 1 x 2 DeBakey Jaws without Ratchet	5 mm Tapered to 7 mm	19 cm	29 cm	FR-9976-29
Harken 1: 7.5 cm Tapered 1 x 2 DeBakey Jaws with Ratchet	5 mm Tapered to 7 mm	19 cm	29 cm	FR-9977-29
Harken 2: 7.5 cm Tapered 1 x 2 DeBakey Jaws without Ratchet	5 mm Tapered to 7 mm	19 cm	29 cm	FR-9978-29
Harken 2: 7.5 cm Tapered 1 x 2 DeBakey Jaws with Ratchet	5 mm Tapered to 7 mm	19 cm	29 cm	FR-9979-29

**Harken Clamps**

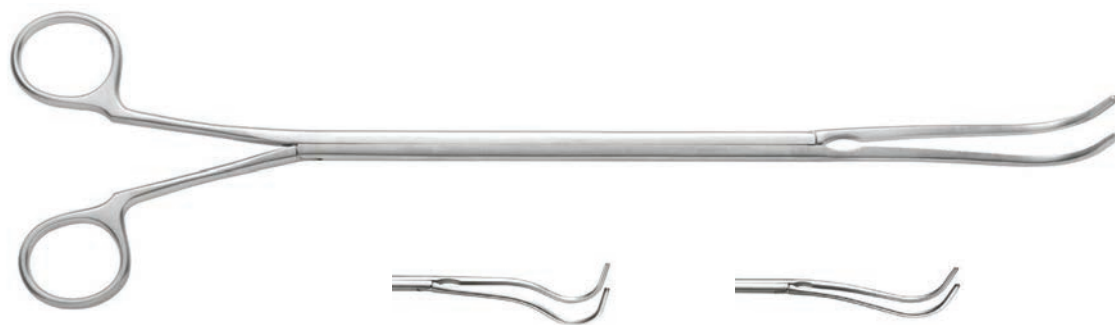

Description	Shaft Thickness	Working Length	Total Length	Code
Harken 1: 9.5 cm Tapered 1 x 2 DeBakey Jaws without Ratchet	10 mm	25 cm	36 cm	FR-9980-36
Harken 1: 9.5 cm Tapered 1 x 2 DeBakey Jaws with Ratchet	10 mm	25 cm	36 cm	FR-9981-36
Harken 2: 9.5 cm Tapered 1 x 2 DeBakey Jaws without Ratchet	10 mm	25 cm	36 cm	FR-9982-36
Harken 2: 9.5 cm Tapered 1 x 2 DeBakey Jaws with Ratchet	10 mm	25 cm	36 cm	FR-9983-36

**Allis Forceps**

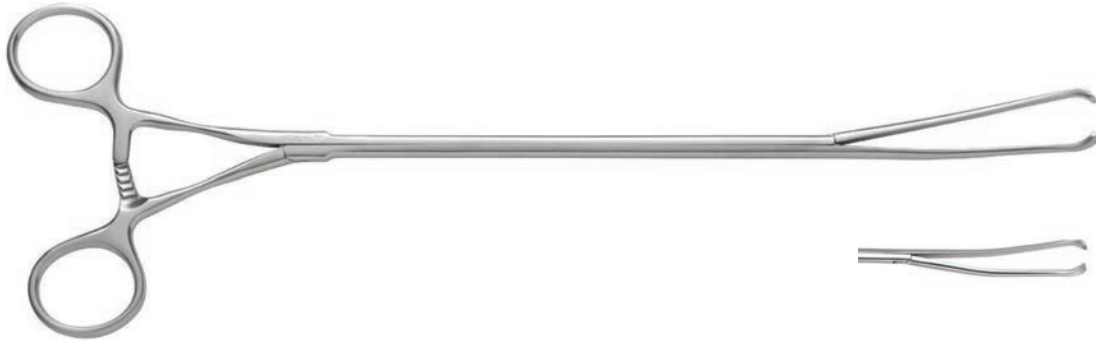

Description	Shaft Thickness	Working Length	Total Length	Code
Curved Left 6 mm Jaws with Ratchet	7 mm	23 cm	34 cm	FR-9984-34

**Allis Forceps**

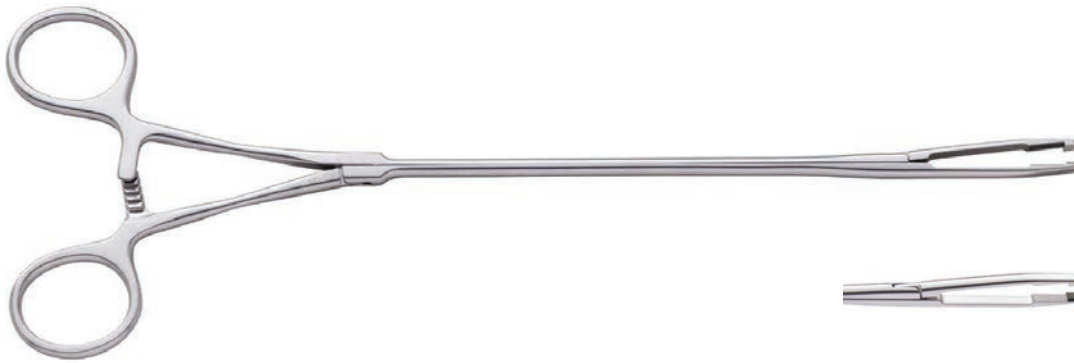

Description	Shaft Thickness	Working Length	Total Length	Code
Curved Left 4 mm Jaws with Ratchet	5 mm Tapered to 7 mm	19 cm	29 cm	FR-9985-29

**Allis Forceps**

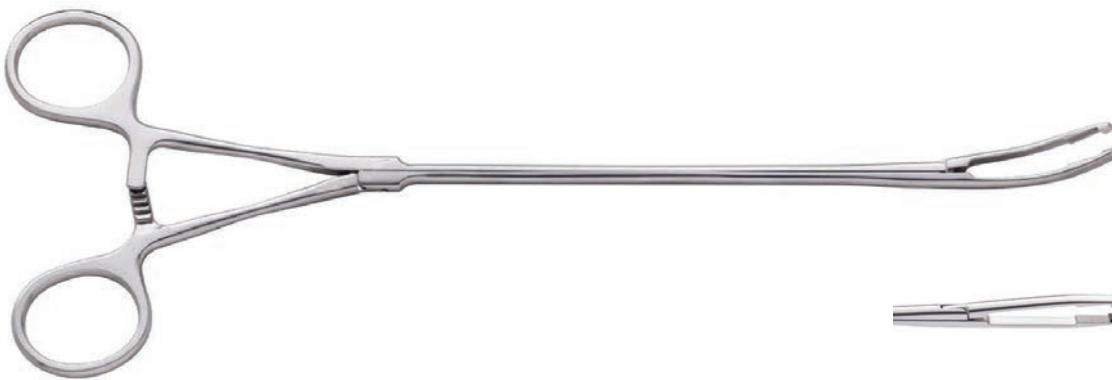

Description	Shaft Thickness	Working Length	Total Length	Code
Curved Left 4 mm Jaws with Ratchet	5 mm Tapered to 7 mm	25 cm	36 cm	FR-9986-36

**MICS Suction Instrument**

Description	Jaw Tip Width	Shaft	Working Length	Total Length	Code
MICS Suction Instrument	5 mm	5 mm	350 mm	47 cm	FR-9933-47

**Knot Pusher**

Description	Jaw Tip Length	Shaft	Working Length	Total Length	Code
Knot Pusher	9 mm	5 mm	230 mm	33 cm	FR-9994-33

**Cardioplegia Needle**

Description	Jaw Tip Length	Shaft	Working Length	Total Length	Code
Needle		5 mm	310 mm	34 cm	FR-9995-34

**Magnet Finder**

Not available  
in every country

Description	Jaw Tip Length	Shaft	Working Length	Total Length	Code
Magnet Finder	20 mm, Ø10 mm	5 mm	240 mm	34 cm	FR-9996-34

### Endo TC Needle Holder Straight



**Description**

Endo TC Needle Holder, Straight,  
LUER lock, irrigation port, massive Axial handle

**Working Length**

Ø 3,0 x 330 mm

**Code**

FR-10-73-500-00

Endo TC Needle Holder, Straight,  
LUER lock, irrigation port, massive Axial handle

Ø 5,0 x 330 mm

FR-10-73-505-00

Endo TC Needle Holder, Straight,  
LUER lock, irrigation port, massive Axial handle

Ø 5,0 x 450 mm

FR-10-73-505 XL

### Endo TC Needle Holder Left Curved



**Description**

Endo TC Needle Holder, Left Curved,  
LUER lock, irrigation port, massive Axial handle

**Working Length**

Ø 3,0 x 330 mm

**Code**

FR-10-73-500-02

Endo TC Needle Holder, Left Curved,  
LUER lock, irrigation port, massive Axial handle

Ø 5,0 x 330 mm

FR-10-73-505-02

Endo TC Needle Holder, Left Curved,  
LUER lock, irrigation port, massive Axial handle

Ø 5,0 x 450 mm

FR-10-73-505-02 XL



**Endo Needle Holder Compact Right Curved**



Description	Working Length	Code
Endo TC Needle Holder, Right Curved LUER lock, irrigation port, massive Axial handle	Ø 3,0 x 330 mm	FR-10-73-500-04
Endo TC Needle Holder, Right Curved LUER lock, irrigation port, massive Axial handle	Ø 5,0 x 330 mm	FR-10-73-505-04
Endo TC Needle Holder, Right Curved LUER lock, irrigation port, massive Axial handle	Ø 5,0 x 450 mm	FR-10-73-505-04 XL

**Endo Needle Holder Compact Curved Up**



Description	Working Length	Code
Endo TC Needle Holder, Curved Up LUER lock, irrigation port, massive Axial handle	Ø 5,0 x 330 mm	FR-10-73-505-06
Endo TC Needle Holder, Curved Up LUER lock, irrigation port, massive Axial handle	Ø 5,0 x 450 mm	FR-10-73-505-06 XL



### Endo Needle Holder Compact Straight

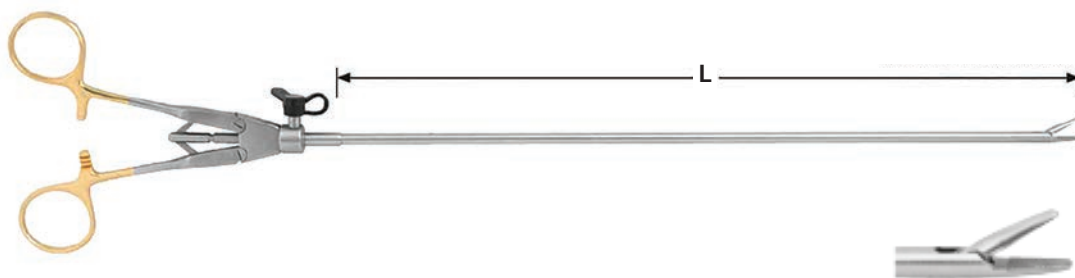

Description	Working Length	Code
Endo TC Needle Holder, Straight LUER lock, irrigation port, ring handle	Ø 5,0 x 330 mm	FR-10-73-506-00

### Endo Needle Holder Compact Left Curved

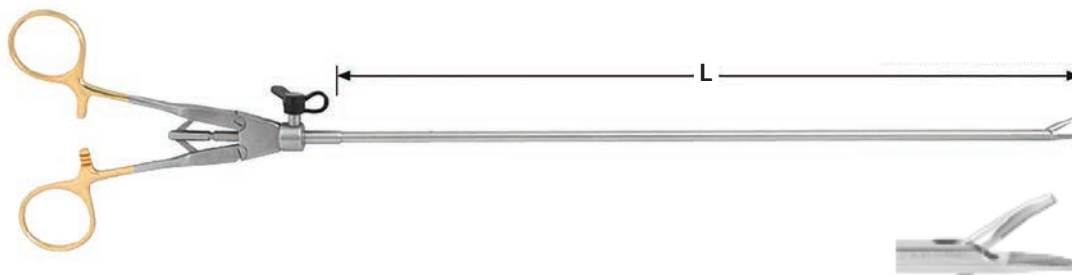

Description	Working Length	Code
Endo TC Needle Holder, Left Curved LUER lock, irrigation port, ring handle	Ø 5,0 x 330 mm	FR-10-73-506-02

### Endo Needle Holder Compact Right Curved

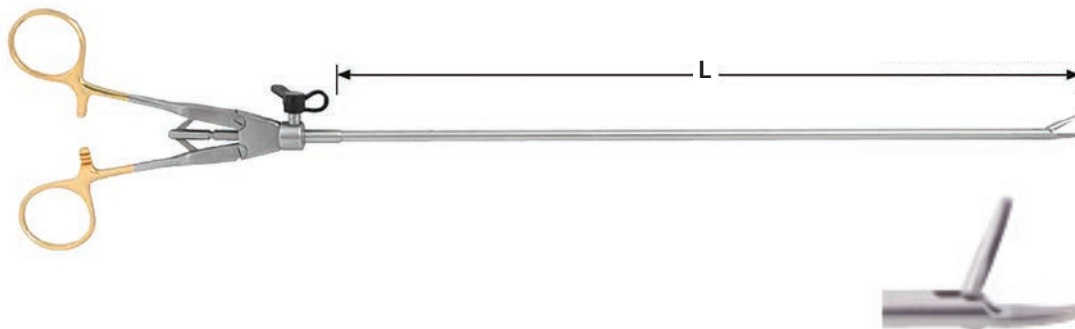

Description	Working Length	Code
Endo TC Needle Holder, Right Curved LUER lock, irrigation port, ring handle	Ø 5,0 x 330 mm	FR-10-73-506-04

**SKILL Light Endo Needle Holder**



Description	Working Length	Code
Endo TC Needle Holder, Straight LUER lock, irrigation port, straight aluminium handle	Ø 3.0 x 330 mm	FR-10-73-502-00
Endo TC Needle Holder, Straight LUER lock, irrigation port, straight aluminium handle	Ø 5.0 x 330 mm	FR-10-73-507-00
Endo TC Needle Holder, Straight LUER lock, irrigation port, straight aluminium handle	Ø 5.0 x 450 mm	FR-10-73-507-00 XL

**SKILL Light Endo Needle Holder**



Description	Working Length	Code
Endo TC Needle Holder, Left Curved LUER lock, irrigation port, straight aluminium handle	Ø 3.0 x 330 mm	FR-10-73-502-02
Endo TC Needle Holder, Left Curved LUER lock, irrigation port, straight aluminium handle	Ø 5.0 x 330 mm	FR-10-73-507-02
Endo TC Needle Holder, Left Curved LUER lock, irrigation port, straight aluminium handle	Ø 5.0 x 450 mm	FR-10-73-507-02 XL



**SKILL Light Endo Needle Holder**



Description	Working Length	Code
Endo TC Needle Holder, Right Curved LUER lock, irrigation port, straight aluminium handle	Ø 3.0 x 330 mm	FR-10-73-502-04
Endo TC Needle Holder, Left Curved LUER lock, irrigation port, straight aluminium handle	Ø 5.0 x 330 mm	FR-10-73-507-04
Endo TC Needle Holder, Left Curved LUER lock, irrigation port, straight aluminium handle	Ø 5.0 x 450 mm	FR-10-73-507-04 XL

**SKILL Light Endo Needle Holder**



Description	Working Length	Code
Endo TC Needle Holder, Curved Up LUER lock, irrigation port, straight aluminium handle self adjusting	Ø 5.0 x 330 mm	FR-10-73-507-08
LUER lock, irrigation port, straight aluminium handle self adjusting	Ø 5.0 x 450 mm	FR-10-73-507-08 XL



**SKILL Light Endo Needle Holder**

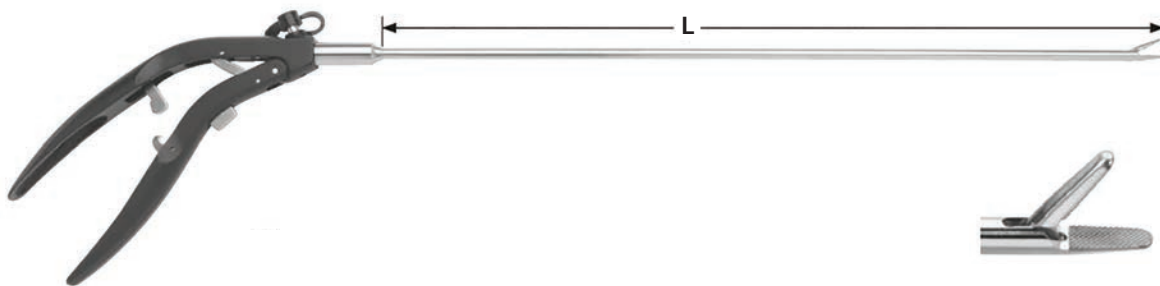

Description	Working Length	Code
Endo TC Needle Holder, Straight LUER lock, irrigation port, angled aluminium handle self adjusting	Ø 3.0 x 330 mm	FR-10-73-503-00
LUER lock, irrigation port, angled aluminium handle self adjusting	Ø 5.0 x 330 mm	FR-10-73-509-00
LUER lock, irrigation port, angled aluminium handle self adjusting	Ø 5.0 x 450 mm	FR-10-73-509-00 XL

**SKILL Light Endo Needle Holder**



Description	Working Length	Code
Endo TC Needle Holder, Left Curved LUER lock, irrigation port, angled aluminium handle self adjusting	Ø 3.0 x 330 mm	FR-10-73-503-02
Endo TC Needle Holder, Left Curved LUER lock, irrigation port, angled aluminium handle self adjusting	Ø 5.0 x 330 mm	FR-10-73-509-02
Endo TC Needle Holder, Left Curved LUER lock, irrigation port, angled aluminium handle self adjusting	Ø 5.0 x 450 mm	FR-10-73-509-02 XL



### SKILL Light Endo Needle Holder

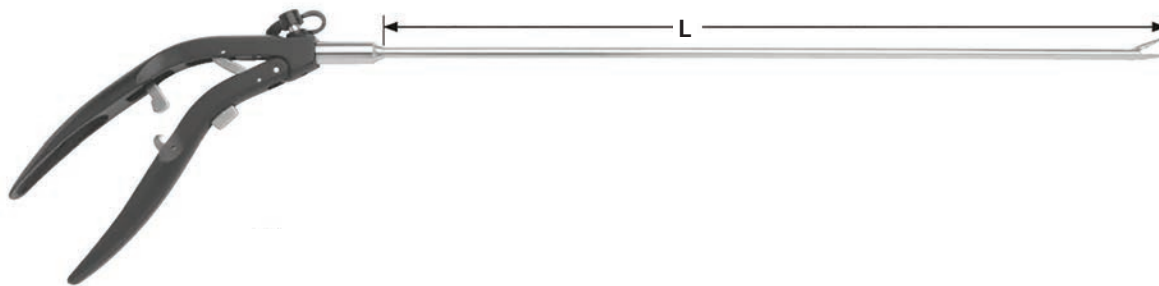

Description	Working Length	Code
Endo TC Needle Holder, Right Curved LUER lock, irrigation port, angled aluminium handle self adjusting	Ø 3.0 x 330 mm	FR-10-73-503-04
Endo TC Needle Holder, Right Curved LUER lock, irrigation port, angled aluminium handle self adjusting	Ø 5.0 x 330 mm	FR-10-73-509-04
Endo TC Needle Holder, Right Curved LUER lock, irrigation port, angled aluminium handle self adjusting	Ø 5.0 x 450 mm	FR-10-73-50--04 XL

### SKILL Light Endo Needle Holder

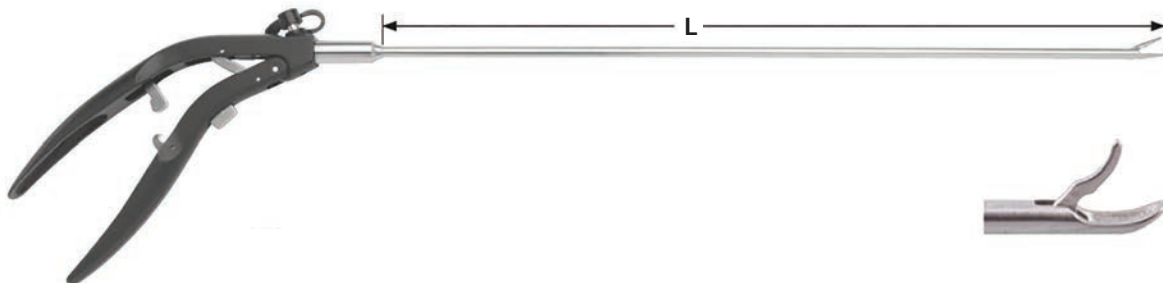

Description	Working Length	Code
Endo TC Needle Holder, Curved Up LUER lock, irrigation port, straight aluminium handle self adjusting	Ø 5.0 x 330 mm	FR-10-73-509-08
Endo TC Needle Holder, Curved Up LUER lock, irrigation port, straight aluminium handle self adjusting	Ø 5.0 x 450 mm	FR-10-73-509-08 XL



**Endo Needle Holder**

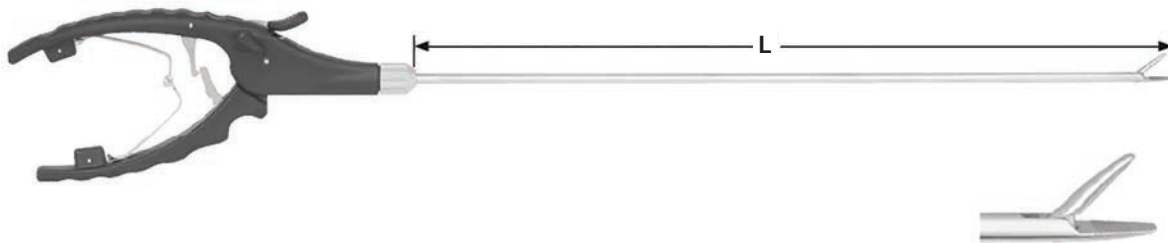

**Description**

Endo TC Needle Holder, Straight, Axial plastic handle

**Working Length**

Ø 5.0 x 330 mm

**Code**

FR-10-73-510-00

**Endo Needle Holder**

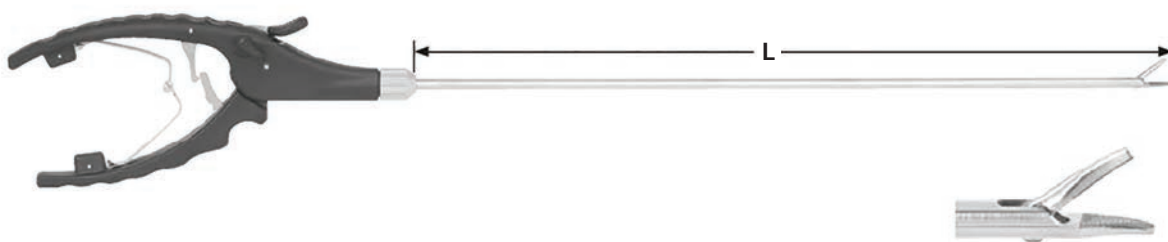

**Description**

Endo TC Needle Holder, Left Curved, Axial plastic handle

**Working Length**

Ø 5.0 x 330 mm

**Code**

FR-10-73-510-02

**Endo Needle Holder**



**Description**

Endo TC Needle Holder, Right Curved, Axial plastic handle

**Working Length**

Ø 5.0 x 330 mm

**Code**

FR-10-73-510-04

### Endo Needle Holder



Description	Working Length	Code
Endo TC Needle Holder, Right Curved, Axial plastic handle	Ø 5.0 x 330 mm	FR-10-73-510-04

### Clip applying Forceps Ø 10.0 mm for Bulldog Clamps

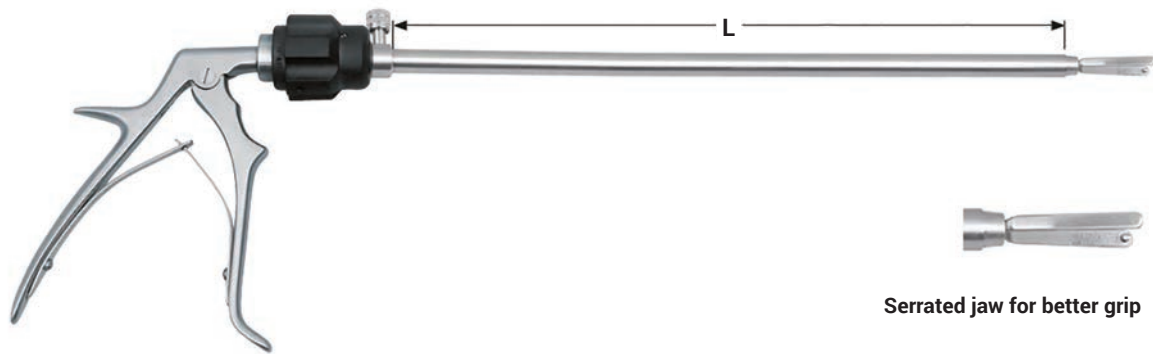

360° Rotatable, LUER LOCK connection

Description	Working Length	Code
Bulldog Clamps Ø 10 mm	330 mm	FR-10-73-580-33



**Bulldog Clamps DeBakey**



2 x 3 Row of Teeth

Description	Jaw Length	Code
Bulldog Clamps Straight	17 mm	FR-10-73-586-17
Bulldog Clamps Straight	25 mm	FR-10-73-586-25
Bulldog Clamps Straight	45 mm	FR-10-73-586-45
Bulldog Clamps Straight	60 mm	FR-10-73-586-60

**Bulldog Clamps DeBakey**



2 x 3 Row of Teeth

Description	Jaw Length	Code
Bulldog Clamps Curved	17 mm	FR-10-73-587-17
Bulldog Clamps Curved	25 mm	FR-10-73-587-25
Bulldog Clamps Curved	45 mm	FR-10-73-587-45
Bulldog Clamps Curved	60 mm	FR-10-73-587-60

**Bulldog Clamps DeBakey-Satinsky**



2 x 3 Row of Teeth

Description	Jaw Length	Code
Bulldog Clamps Curved	17 mm	FR-10-73-587-17
Bulldog Clamps Curved	25 mm	FR-10-73-587-25
Bulldog Clamps Curved	45 mm	FR-10-73-587-45
Bulldog Clamps Curved	60 mm	FR-10-73-587-60

**Fan Retractors**



**Description**

Fan Retractors, 5 Fingers, irrigation channel

**Jaw Length**

Ø 5,0 x 340 mm

**Code**

FR-10-73-707-34

**Fan Retractors**

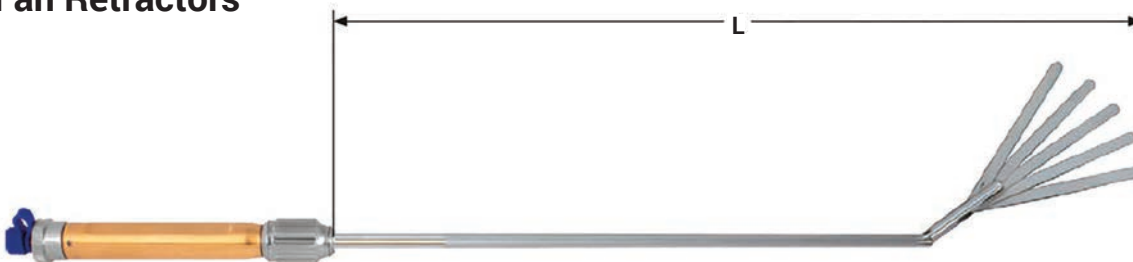

**Description**

Fan Retractors, 5 Fingers, 50° angle, irrigation channel

**Jaw Length**

Ø 5,0 x 340 mm

**Code**

FR-10-73-707-34

**Fan Retractors**



**Description**

Fan Retractors, 5 Fingers, irrigation channel

**Jaw Length**

Ø 10,0 x 340 mm

**Code**

FR-10-73-709-34

**Fan Retractors**



**Description**

Fan Retractors, 5 Fingers, 50° angle, irrigation channel

**Jaw Length**

Ø 10,0 x 340 mm

**Code**

FR-10-73-710-34

**Fan Retractors**



**Description**

Fan Retractors, 3 Fingers, 60° angle, irrigation channel, detachable

**Jaw Length**

Ø 50,0 x 330 mm

**Code**

FR-10-73-703-33

Fan Retractors, 3 Fingers, 60° angle, irrigation channel, detachable

Ø 50,0 x 450 mm

FR-10-73-703-45

**Fan Retractors**

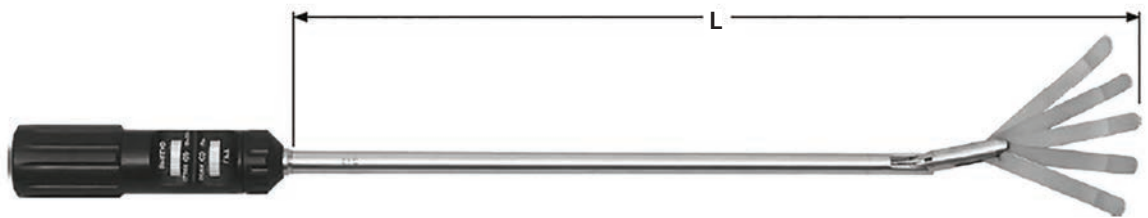

**Description**

Fan Retractors, 5 Fingers, 80° angle, irrigation channel, detachable

**Jaw Length**

Ø 10,0 x 330 mm

**Code**

FR-10-73-705-33

Fan Retractors, 5 Fingers, 80° angle, irrigation channel, detachable

Ø 10,0 x 450 mm

FR-10-73-705-45

**Endo Retractors, angle with Luer-Lock irrigation channel**

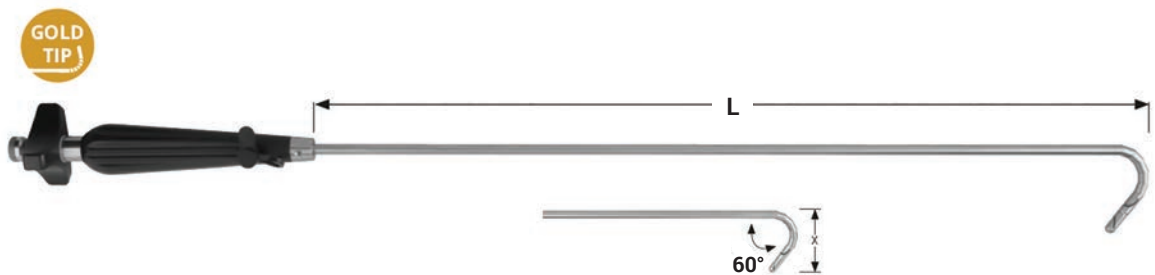

**Description**

Finger Retractor, 60° angle, X = 40 mm L = 380 mm

**Jaw Length**

Ø 5,0

**Code**

FR-10-73-712-40

Endo Retractors, angle with Luer-Lock irrigation channel

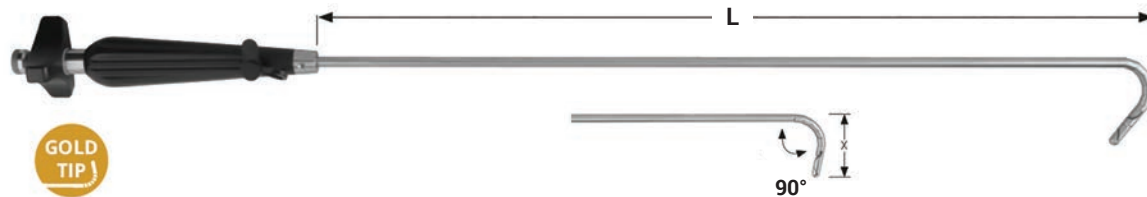

**Description**

Finger Retractor, 90° angle, X = 40 mm L = 430 mm

**Jaw Length**

Ø 5,0

**Code**

FR-10-73-712-40 XL

Endo Retractors, angle with Luer-Lock irrigation channel



**Description**

Triangular Retractor, X = 60 mm L = 380 mm

Triangular Retractor, X = 60 mm L = 450 mm

**Jaw Length**

Ø 5,0

Ø 5,0

**Code**

FR-10-73-712-60

FR-10-73-712-60 XL

Endo Retractors, angle with Luer-Lock irrigation channel



**Description**

Triangular Retractor, X = 80 mm L = 380 mm

Triangular Retractor, X = 80 mm L = 450 mm

**Jaw Length**

Ø 5,0

Ø 5,0

**Code**

FR-10-73-712-80

FR-10-73-712-80 XL

Endo Retractors, angle with Luer-Lock irrigation channel



Description	Jaw Length	Code
Triangular Retractor, X = 120 mm L = 380 mm	Ø 5,0	FR-10-73-712-12
Triangular Retractor, X = 120 mm L = 450 mm	Ø 5,0	FR-10-73-712-12 XL

Endo Retractors, angle with Luer-Lock irrigation channel



Description	Jaw Length	Code
Triangular Retractor, angled X = 60 mm L = 380 mm	Ø 5,0	FR-10-73-713-60
Triangular Retractor, angled X = 60 mm L = 450 mm	Ø 5,0	FR-10-73-713-60 XL

Endo Retractors, angle with Luer-Lock irrigation channel

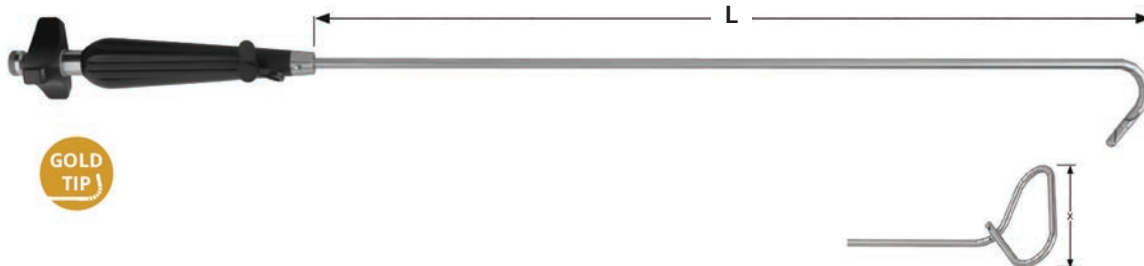

Description	Jaw Length	Code
Triangular Retractor, angled X = 80 mm L = 380 mm	Ø 5,0	FR-10-73-713-80
Triangular Retractor, angled X = 80 mm L = 450 mm	Ø 5,0	FR-10-73-713-80 XL

Endo Retractors, angle with Luer-Lock irrigation channel

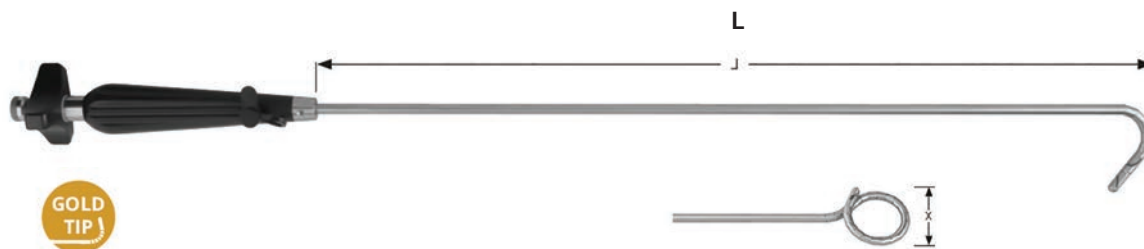

GOLD TIP

Description

Triangular Retractor, circular X = 40 mm L = 380 mm

Triangular Retractor, circular X = 40 mm L = 450 mm

Jaw Length

Ø 5,0

Ø 5,0

Code

FR-10-73-714-40

FR-10-73-714-40 XL

Endo Retractors, angle with Luer-Lock irrigation channel

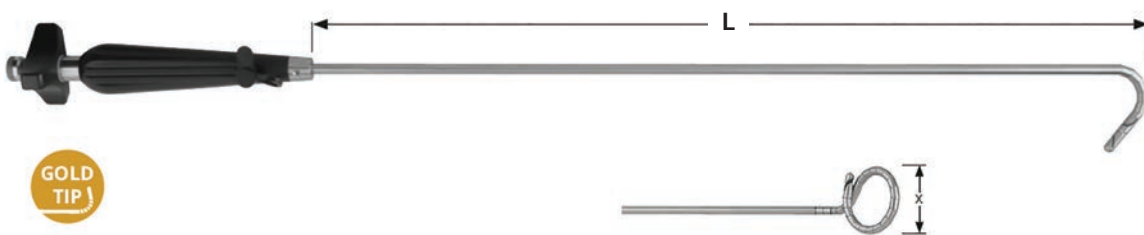

GOLD TIP

Description

Triangular Retractor, circular angled X = 40 mm L = 380 mm

Triangular Retractor, circular angled X = 40 mm L = 450 mm

Jaw Length

Ø 5,0

Ø 5,0

Code

FR-10-73-715-40

FR-10-73-715-40 XL

Endo Retractors, angle with Luer-Lock irrigation channel



GOLD TIP

Description

Endo Retractor, hooked shape left, 45° angled downwards, L = 380 mm

Endo Retractor, hooked shape left, 45° angled downwards, L = 450 mm

Jaw Length

Ø 5,0

Ø 5,0

Code

FR-10-73-716-45

FR-10-73-716-45 XL

Endo Retractors, angle with Luer-Lock irrigation channel

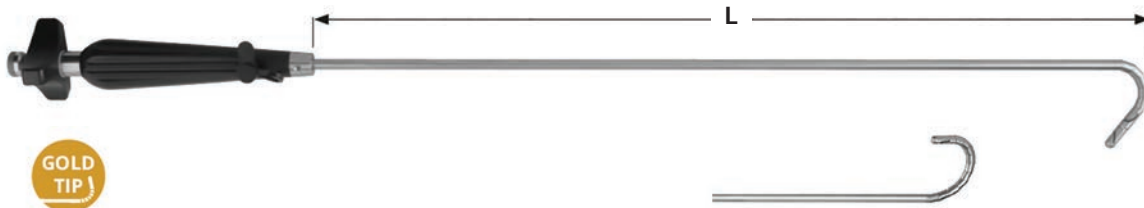

Description	Jaw Length	Code
Endo Retractor, hooked shape right, 45° angled downwards, L = 380 mm	Ø 5,0	FR-10-73-717-45
Endo Retractor, hooked shape right, 45° angled downwards, L = 450 mm	Ø 5,0	FR-10-73-717-45 XL

Endo Retractors, angle with Luer-Lock irrigation channel



Description	Jaw Length	Code
Endo Retractor, hooked shape right, 45° angled downwards, L = 380 mm	Ø 5,0	FR-10-73-717-45
Endo Retractor, hooked shape right, 45° angled downwards, L = 450 mm	Ø 5,0	FR-10-73-717-45 XL

Endo Retractors, angle with Luer-Lock irrigation channel



Description	Jaw Length	Code
Endo Retractor, hooked shape left, 90° angled downwards, L = 380 mm	Ø 5,0	FR-10-73-716-90
Endo Retractor, hooked shape left, 90° angled downwards, L = 450 mm	Ø 5,0	FR-10-73-716-90 XL

**Endo Retractors, angle with Luer-Lock irrigation channel**

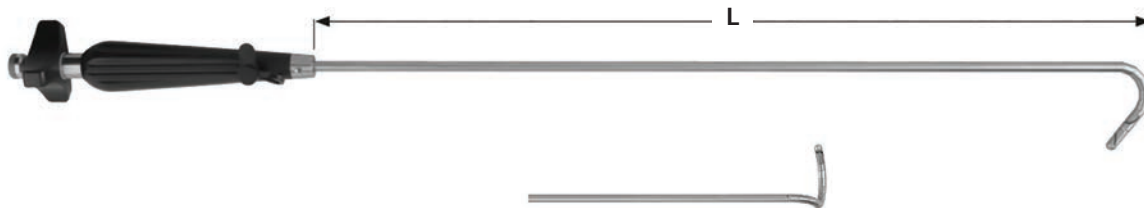

Description	Jaw Length	Code
Endo Retractor, hooked shape right, 90° angled downwards, L = 380 mm	Ø 5,0	FR-10-73-7167-90
Endo Retractor, hooked shape right, 90° angled downwards, L = 450 mm	Ø 5,0	FR-10-73-717-90 XL

**SKILL Thoracic Suction Tube**

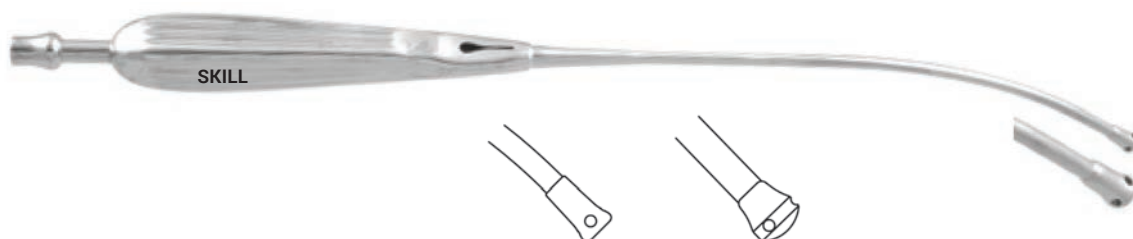

Description	Total Length	Code
Finger tip controlled suction regulator 3.5 mm shaft / 5.8 mm tip	35 cm	FR-10-180-35
Finger tip controlled suction regulator 3.5 mm shaft / 5.8 mm tip	40 cm	FR-10-181-40

**SKILL Thoracic Suction Tube**

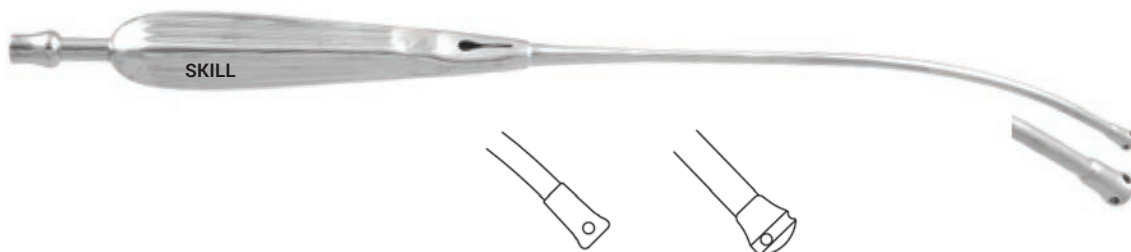

Description	Total Length	Code
Finger tip controlled suction regulator 4.9 mm shaft / 8 mm tip	40 cm	FR-10-182-40
Finger tip controlled suction regulator 3.5 mm shaft / 7.9 mm tip	45 cm	FR-10-183-45

**SKILL Thoracic Suction Tube**



Description	Total Length	Code
With Yankauer handle / 5 mm tube / 17 1/4" Straight	44 cm	FR-10-184-44

**SKILL Thoracic Suction Tube**



Description	Total Length	Code
With Yankauer handle / 5 mm tube / 17 1/4" Angled	44 cm	FR-10-185-44

**SKILL Thoracic Suction Tube**



Description	Total Length	Code
With Yankauer handle / 5 mm tube / 17 1/4" Straight with basket tip	44 cm	FR-10-186-44

**SKILL Thoracic Suction Tube**



Description	Total Length	Code
With Yankauer handle / 5 mm tube / 17 1/4" Angled with basket tip	44 cm	FR-10-187-44

**SKILL Thoracic Suction Tube**



Description	Total Length	Code
With Yankauer handle / 10 mm tube / 18 3/4" Straight	48 cm	FR-10-188-48

**SKILL Thoracic Suction Tube**



Description	Total Length	Code
With Yankauer handle / 10 mm tube / 18 1/2" Angled	47 cm	FR-10-189-47



## Adam Yozu Retractor

**Description**

Adam Yozu Retractor 55 mm x 50 mm x 100 mm x 95 mm

Exchangeable Blades 65 mm x 50 mm Set

**Code**

CB1-10-719-03

Adam Yozu Retractor

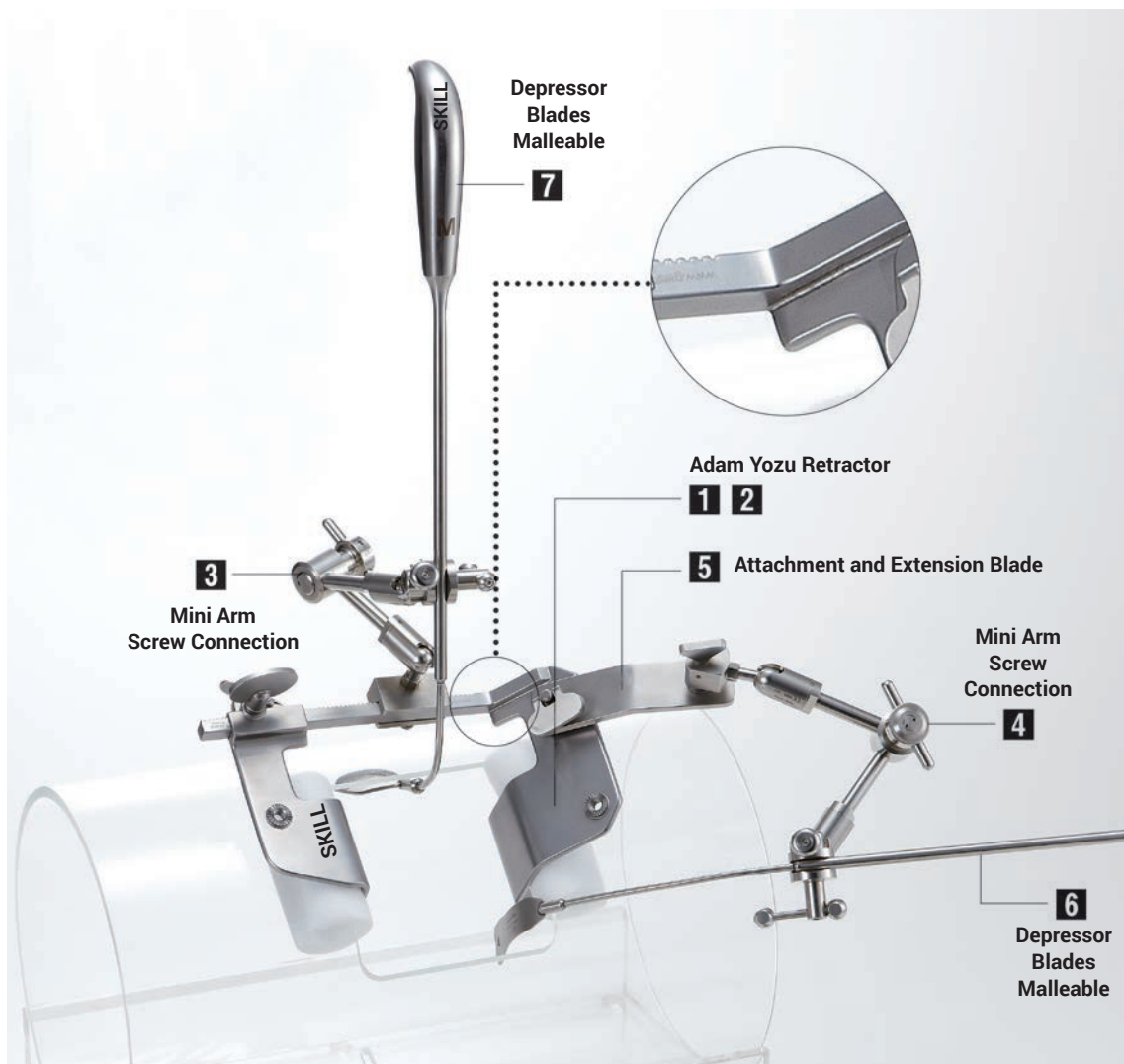

Exchangeable Blades



Mini Arm Screw Connection

**Description**

Adam Yozu Retractor 45 mm x 40 mm x 100 mm x 95 mm  
 Exchangeable Blades 55 mm x 40 mm Set

**Code**

CB1-10-719-02

**Description**

Mini Arm with Screw Connection

**Code**

CB1-10-719-10

### Adam Yozu Retractor

Description	Code
Mini Arm with Screw Connector	CB1-10-719-11
Mini Arm with Quick Connector for Spreading Bar	CB1-10-719-12
Attachment and Extension Blade	CB1-10-719-13

Description	Total Length			Code
Depressor Blade Malleable XXS, Paediatric	46 cm	85 mm	18 mm	CB1-10-719-14
Depressor Blade Malleable XS	44 cm	70 mm	23 mm	CB1-10-719-15
Depressor Blade Malleable S	44 cm	70 mm	28 mm	CB1-10-719-16
Depressor Blade Malleable M	44 cm	70 mm	35 mm	CB1-10-719-17
Depressor Blade Malleable L	44 cm	70 mm	45 mm	CB1-10-719-18
Depressor Blade Malleable XL	47 cm	90 mm	45 mm	CB1-10-719-19

Description	Total Length			Code
Spatula Malleable	36 cm	70 mm	20 mm	CB1-10-719--20

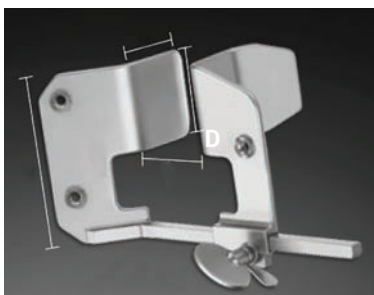

	A	B	C	D
Retractor	55 mm	50 mm	100 mm	95 mm
	65 mm	50 mm		
Small Version	45 mm	40 mm	100 mm	95 mm
	55 mm	40 mm		



**Mini-Thoracotomy Retractor Straight**

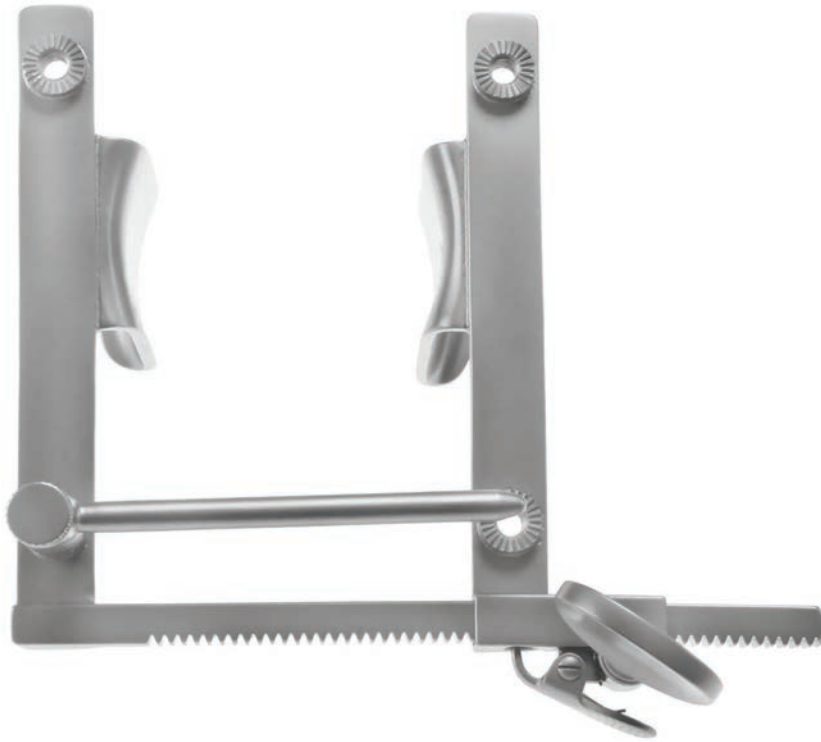

**Description**

Mini Thoracotomy w Straight  
Arms 40 mm x 60 mm Blades Turnable Crossbar

**Code**

CB1-10-9850-00

**Mini-Thoracotomy Retractor Curved Arms**

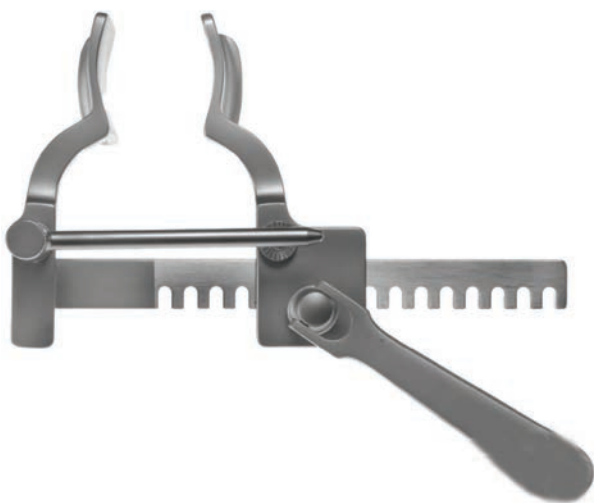

**Description**

Mini Thoracotomy Retractor Curved Arms 36 mm x 60 mm Blades Strong  
Spreading Bar attachments

**Code**

CB1-10-9851-00

Mini-Thoracotomy Retractor Curved Arms



Description	Code
Mini Thoracotomy Retractor Hinged Arms 2 x 2 Exchangeable Blades 36 mm x 38 mm, 36 mm x 52 mm	
Turnable Crossbar for attachments	CB1-10-9852-00

Fixation Clamps

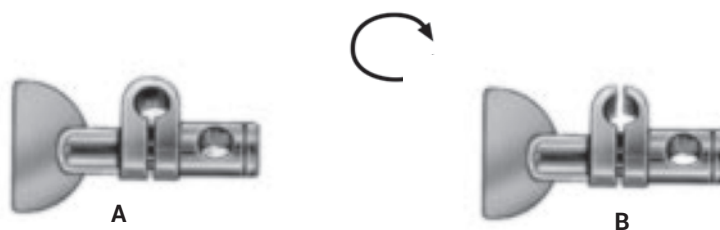

Description	Fig	Ø mm	Length mm	Code
Fixation Clamps	A	6		CB1-10-9853-01
Fixation Clamps	B	6	Splitted	CB1-10-9853-02

# SKILL<sup>®</sup>

Surgical Instruments

## SPECIALITY INSTRUMENTS





# Index

## Speciality Instruments

DeBakey Bulldog Clamp	456
Titanium DeBakey Bulldog Clamp	456-457
Glover Bulldog Clamp	457
Diethrich Bulldog Clamp	458-459
Titanium Vena Cava Bulldog Clamp	460-461
Frasier Suction Tube	461
Yankauer Suction Tube	462
Poole Suction Tube	463-464
Cardiac Suction Tube   Andrew Pynchon Suction Tube	465-466
Pediatric Cardiac Suction Tube	466-467
Finsterer Suction Tube	467
Yankauer Suction Tube	468
Tunneling Set	469
Tibbs Arterial Cannula   Ross Sump Sucker	470
Cooley Vascular Dilator	471
DeBakey Vascular Dilator	473
Garrett Vascular Dilator	473
Bakes Dilator Set	474
DeBakey Vascular Dilators Titanium Handle   Leksell Bone Rongeur	475
Cushing Nerve Hook	476
Hegar Dilator Set   Tubbs Aortic Dilator	477
Cardiac Tube Holders	478
Ligature Catcher	479



### DeBakey Bulldog Clamp Straight



Description	Length	Code
DeBakey Bulldog Clamp Straight	8 cm	BF-507-08
DeBakey Bulldog Clamp Straight	9 cm	BF-507-09
DeBakey Bulldog Clamp Straight	10 cm	BF-507-10
DeBakey Bulldog Clamp Straight	12 cm	BF-507-12

### DeBakey Bulldog Clamp Curved



Description	Length	Code
DeBakey Bulldog Clamp Curved	8 cm	BF-508-08
DeBakey Bulldog Clamp Curved	9 cm	BF-508-09
DeBakey Bulldog Clamp Curved	10 cm	BF-508-10
DeBakey Bulldog Clamp Curved	12 cm	BF-508-12

### Titanium DeBakey Bulldog Clamp Straight



Description	Length	Code
Titanium DeBakey Bulldog Clamp Straight	7 cm	BF-507-07T
Titanium DeBakey Bulldog Clamp Straight	8 cm	BF-507-08T
Titanium DeBakey Bulldog Clamp Straight	9 cm	BF-507-09T
Titanium DeBakey Bulldog Clamp Straight	10 cm	BF-507-10T
Titanium DeBakey Bulldog Clamp Straight	11 cm	BF-507-11T
Titanium DeBakey Bulldog Clamp Straight	12 cm	BF-507-12T
Titanium DeBakey Bulldog Clamp Straight	13 cm	BF-507-13T

### Titanium DeBakey Bulldog Clamp Curved



Description	Length	Code
Titanium DeBakey Bulldog Clamp Curved	7 cm	BF-508-07T
Titanium DeBakey Bulldog Clamp Curved	8 cm	BF-508-08T
Titanium DeBakey Bulldog Clamp Curved	9 cm	BF-508-09T
Titanium DeBakey Bulldog Clamp Curved	10 cm	BF-508-10T
Titanium DeBakey Bulldog Clamp Curved	11 cm	BF-508-11T
Titanium DeBakey Bulldog Clamp Curved	12 cm	BF-508-12T
Titanium DeBakey Bulldog Clamp Curved	13 cm	BF-508-13T

### Glover Bulldog Clamp Straight



Description	Length	Code
Glover Bulldog Clamp Straight	6 cm	BF-509-06
Glover Bulldog Clamp Straight	7 cm	BF-509-07
Glover Bulldog Clamp Straight	10 cm	BF-509-10
Glover Bulldog Clamp Straight	12 cm	BF-509-12

### Glover Bulldog Clamp Curved



Description	Length	Code
Glover Bulldog Clamp Curved	6 cm	BF-510-06
Glover Bulldog Clamp Curved	7 cm	BF-510-07
Glover Bulldog Clamp Curved	10 cm	BF-510-10
Glover Bulldog Clamp Curved	12 cm	BF-510-12

**Diethrich Bulldog Clamp**



Description	Length	Code
Diethrich Bulldog Clamp Straight	8 cm	BF-511-08
Diethrich Bulldog Clamp Straight	12 cm	BF-511-12
Diethrich Bulldog Clamp Straight	20 cm	BF-511-20
Diethrich Bulldog Clamp Angled	8 cm	BF-512-08
Diethrich Bulldog Clamp Angled	12 cm	BF-512-12
Diethrich Bulldog Clamp Angled	20 cm	BF-512-20

**Titanium Diethrich Bulldog Clamp**



Description	Length	Code
Titanium Diethrich Bulldog Clamp Straight	8 cm	BF-511-08T
Titanium Diethrich Bulldog Clamp Straight	12 cm	BF-511-12T
Titanium Diethrich Bulldog Clamp Straight	20 cm	BF-511-20T
Titanium Diethrich Bulldog Clamp Angled	8 cm	BF-512-08T
Titanium Diethrich Bulldog Clamp Angled	12 cm	BF-512-12T
Titanium Diethrich Bulldog Clamp Angled	20 cm	BF-512-20T



### DeBakey Diethrich Bulldog Clamp



Description	Length	Code
DeBakey Diethrich Bulldog Clamp Straight	10 cm	BF-512-10
DeBakey Diethrich Bulldog Clamp Straight	14 cm	BF-512-14
DeBakey Diethrich Bulldog Clamp Straight	20 cm	BF-512-20
DeBakey Diethrich Bulldog Clamp Angled	10 cm	BF-513-10
DeBakey Diethrich Bulldog Clamp Angled	14 cm	BF-513-14
DeBakey Diethrich Bulldog Clamp Angled	20 cm	BF-513-20
DeBakey Diethrich Bulldog Clamp Curved	10 cm	BF-514-10
DeBakey Diethrich Bulldog Clamp Curved	14 cm	BF-514-14
DeBakey Diethrich Bulldog Clamp Curved	20 cm	BF-514-20

### Titanium DeBakey Diethrich Bulldog Clamp



Description	Length	Code
Titanium DeBakey Diethrich Bulldog Clamp Straight	10 cm	BF-512-10T
Titanium DeBakey Diethrich Bulldog Clamp Straight	14 cm	BF-512-14T
Titanium DeBakey Diethrich Bulldog Clamp Straight	20 cm	BF-512-20T
Titanium DeBakey Diethrich Bulldog Clamp Angled	10 cm	BF-513-10T
Titanium DeBakey Diethrich Bulldog Clamp Angled	14 cm	BF-513-14T
Titanium DeBakey Diethrich Bulldog Clamp Angled	20 cm	BF-513-20T
Titanium DeBakey Diethrich Bulldog Clamp Curved	10 cm	BF-514-10T
Titanium DeBakey Diethrich Bulldog Clamp Curved	14 cm	BF-514-14T
Titanium DeBakey Diethrich Bulldog Clamp Curved	20 cm	BF-514-20T

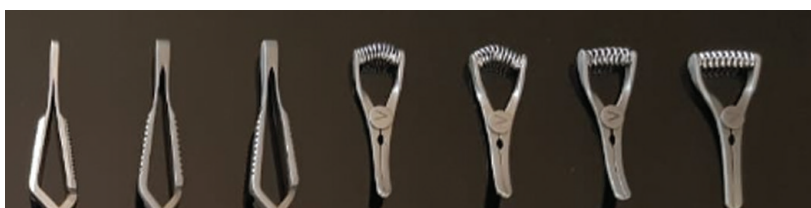

**Titanium Vena Cava Bulldog Clamp Straight**

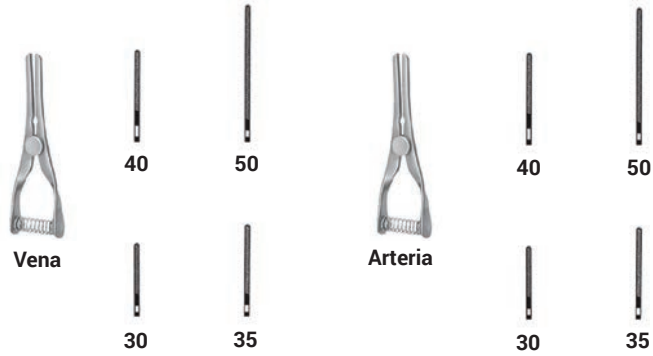

**Description**

- Vena Bulldog Clamp Straight 30 mm
- Vena Bulldog Clamp Straight 35 mm
- Vena Bulldog Clamp Straight 40 mm
- Vena Bulldog Clamp Straight 50 mm
- Arteria Bulldog Clamp Straight 30 mm
- Arteria Bulldog Clamp Straight 35 mm
- Arteria Bulldog Clamp Straight 40 mm
- Arteria Bulldog Clamp Straight 50 mm

**Code**

- BF-513-30
- BF-513-35
- BF-513-40
- BF-513-50
- BF-514-30
- BF-514-35
- BF-514-40
- BF-514-50

**Titanium Vena Cava Bulldog Clamp Curved**

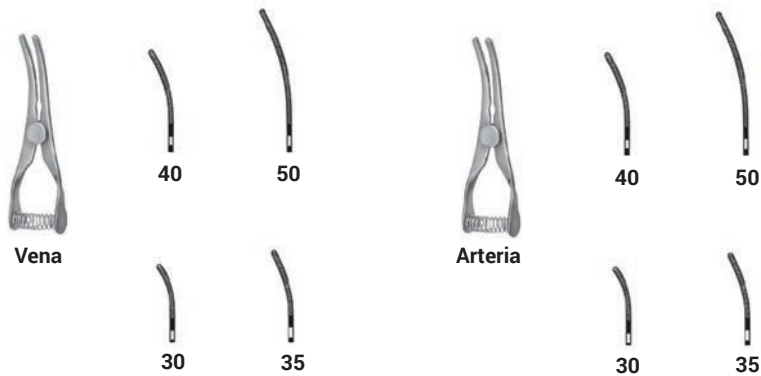

**Description**

- Vena Bulldog Clamp Curved 30 mm
- Vena Bulldog Clamp Curved 35 mm
- Vena Bulldog Clamp Curved 40 mm
- Vena Bulldog Clamp Curved 50 mm
- Arteria Bulldog Clamp Curved 30 mm
- Arteria Bulldog Clamp Curved 35 mm
- Arteria Bulldog Clamp Curved 40 mm
- Arteria Bulldog Clamp Curved 50 mm

**Code**

- BF-515-30
- BF-515-35
- BF-515-40
- BF-515-50
- BF-516-30
- BF-516-35
- BF-516-40
- BF-516-50

### Titanium Vena Cava Bulldog Clamp Fully Curved

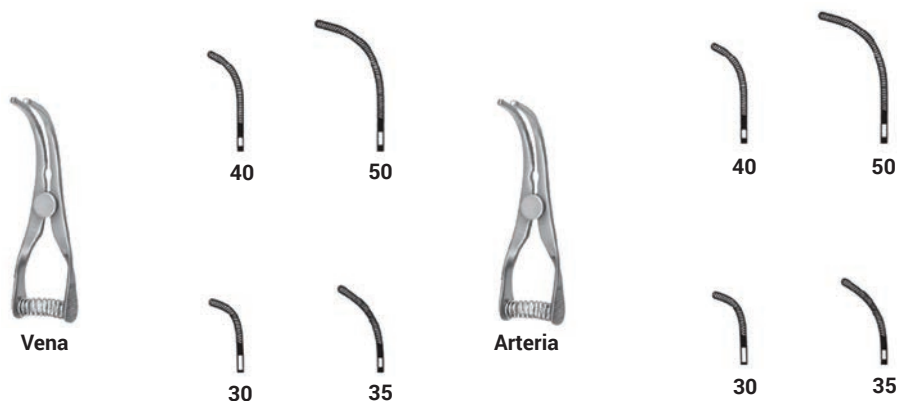

**Description**

- Vena Bulldog Clamp Fully Curved 30 mm
- Vena Bulldog Clamp Fully Curved 35 mm
- Vena Bulldog Clamp Fully Curved 40 mm
- Vena Bulldog Clamp Fully Curved 50 mm
- Arteria Bulldog Clamp Fully Curved 30 mm
- Arteria Bulldog Clamp Fully Curved 35 mm
- Arteria Bulldog Clamp Fully Curved 40 mm
- Arteria Bulldog Clamp Fully Curved 50 mm

**Code**

- BF-517-30
- BF-517-35
- BF-517-40
- BF-517-50
- BF-518-30
- BF-518-35
- BF-518-40
- BF-518-50

### Frasier Suction Tube

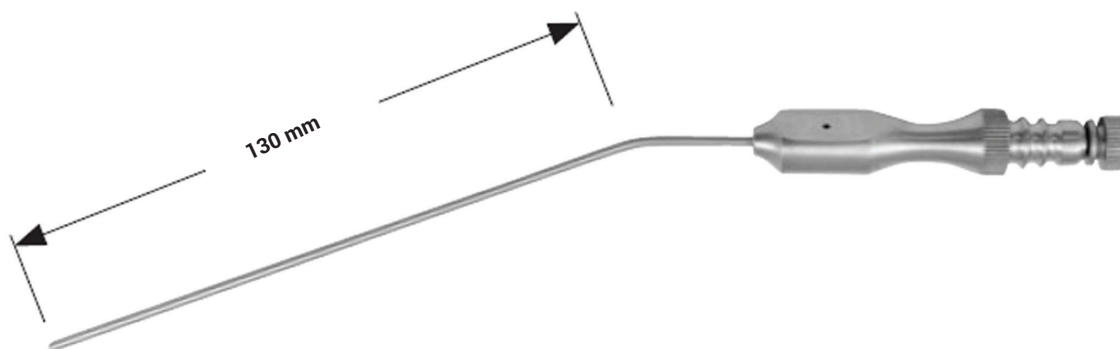

**Description**

- Frasier Suction Tube 6FR
- Frasier Suction Tube 7FR
- Frasier Suction Tube 8FR
- Frasier Suction Tube 9FR
- Frasier Suction Tube 10FR
- Frasier Suction Tube 11FR
- Frasier Suction Tube 12FR
- Frasier Suction Tube 15FR

**Length**

- 16 cm
- 16 cm
- 16 cm
- 16 cm
- 16 cm
- 16 cm
- 16 cm
- 16 cm

**Code**

- BA-503-06
- BA-503-07
- BA-503-08
- BA-503-09
- BA-503-10
- BA-503-11
- BA-503-12
- BA-503-15

Yankauer Suction Tube



Description

Yankauer Suction Tube

Length

27 cm

Code

BA-911-01



## Poole Suction Tube

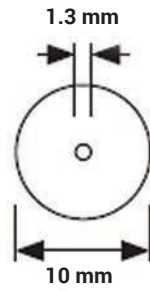

## Description

Poole Suction Tube

## Length

22 cm

## Code

BA-914-10

SPECIALITY INSTRUMENTS



# SPECIALITY INSTRUMENTS

**Poole Suction Tube**



Description	Length	Code
Poole Suction Tube 6mm	20 cm	BA-915-06
Poole Suction Tube 8 mm	20 cm	BA-915-08

**Poole Suction Tube**



Description	Length	Code
Poole Suction Tube 10 mm	22 cm	BA-916-10



**Cardiac Suction Tube**



Description	Length	Code
Cardiac Suction Tube 10 mm	38 cm	BA-917-38

**Andrew Pynchon Suction Tube**



Description	Length	Code
Andrew Pynchon Suction Tube	38 cm	BA-918-38



**SPECIALITY INSTRUMENTS**

**Cardiac Suction Tube**



Description	Length	Code
Cardiac Suction Tube 10 mm	25 cm	BA-919-25

**Pediatric Cardiac Suction Tube**



Description	Length	Code
Pediatric Cardiac Suction 6 mm	26 cm	BA-920-26
Pediatric Cardiac Suction 8 mm	26 cm	BA-927-26
Pediatric Suction Tube 10 mm	26 cm	BA-928-26



**Pediatric Cardiac Suction Tube**



Description	Length	Code
Pediatric Cardiac Suction Tube Removable Tip 6 mm	26 cm	BA-930-26
Pediatric Cardiac Suction Tube Removable Tip 8 mm	26 cm	BA-931-26
Pediatric Cardiac Suction Tube Removable Tip 10 mm	26 cm	BA-932-26

**Finsterer Suction Tube**



Description	Length	Code
Finsterer Suction Tube	32 cm	BA-933-32



**SPECIALITY INSTRUMENTS**

Yankauer Suction Tube



**Description**

Yankauer Suction Tube

**Length**

27 cm

**Code**

BA-934-27

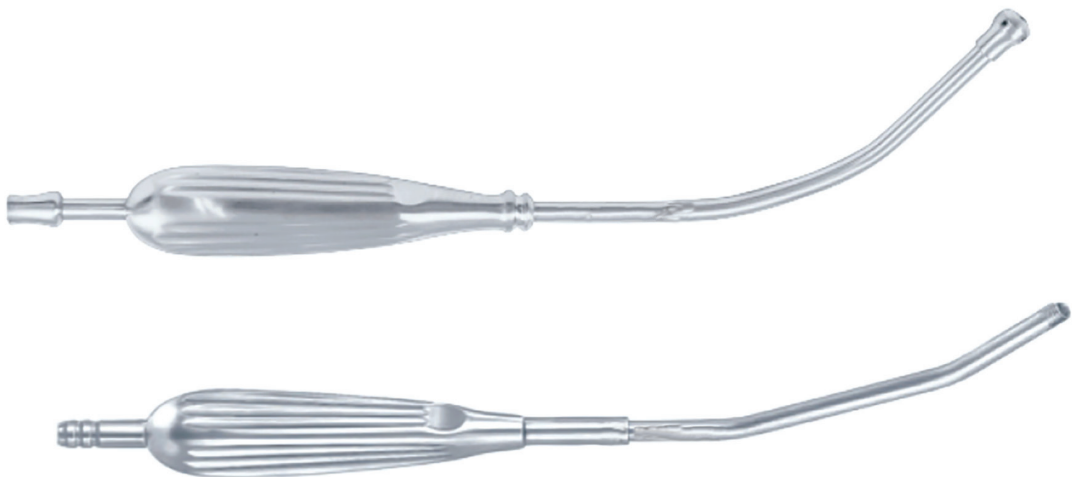

## Tunneling Set



### Tunneling Set

1. Handle for Tunneling Set
2. Tunneling Shafts x 3
3. Tunneling Tip x 4 (6 mm, 8 mm, 10 mm, 12 mm)
4. Vein Tip x 1
5. Luer Adaptor
6. Storage Case Stainless

### Description

Tunneling Set

### Code

CC-9800-00S



### Tibbs Arterial Cannula



#### Description

Tibbs Arterial Cannula 58 mm A  
 Tibbs Arterial Cannula 58 mm B  
 Tibbs Arterial Cannula 58 mm C  
 Tibbs Arterial Cannula 58 mm D

#### Code

BA-917-01  
 BA-917-02  
 BA-917-03  
 BA-917-04

### Ross Sump Sucker



#### Description

Ross Sump Sucker Infant  
 Ross Sump Sucker Child  
 Ross Sump Sucker Adult

#### Code

BA-918-01  
 BA-918-02  
 BA-918-03



### Cooley Vascular Dilator

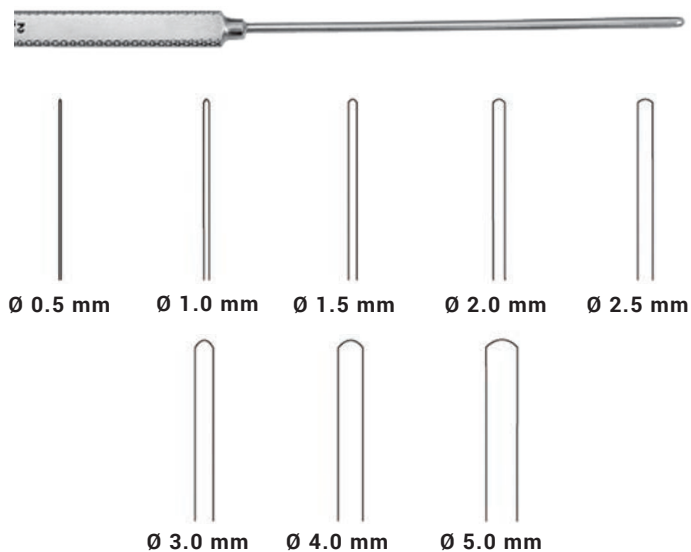

**Description**

Cooley Vascular Dilator 0,5 mm  
 Cooley Vascular Dilator 1 mm  
 Cooley Vascular Dilator 1,5 mm  
 Cooley Vascular Dilator 2 mm  
 Cooley Vascular Dilator 2,5 mm  
 Cooley Vascular Dilator 3 mm  
 Cooley Vascular Dilator 4 mm  
 Cooley Vascular Dilator 5 mm

**Length**

13 cm  
 13 cm  
 13 cm  
 13 cm  
 13 cm  
 13 cm  
 13 cm  
 13 cm

**Code**

CC-1300-01  
 CC-1300-02  
 CC-1300-03  
 CC-1300-04  
 CC-1300-05  
 CC-1300-06  
 CC-1300-07  
 CC-1300-08



SPECIALITY INSTRUMENTS

## DeBakey Vascular Dilator

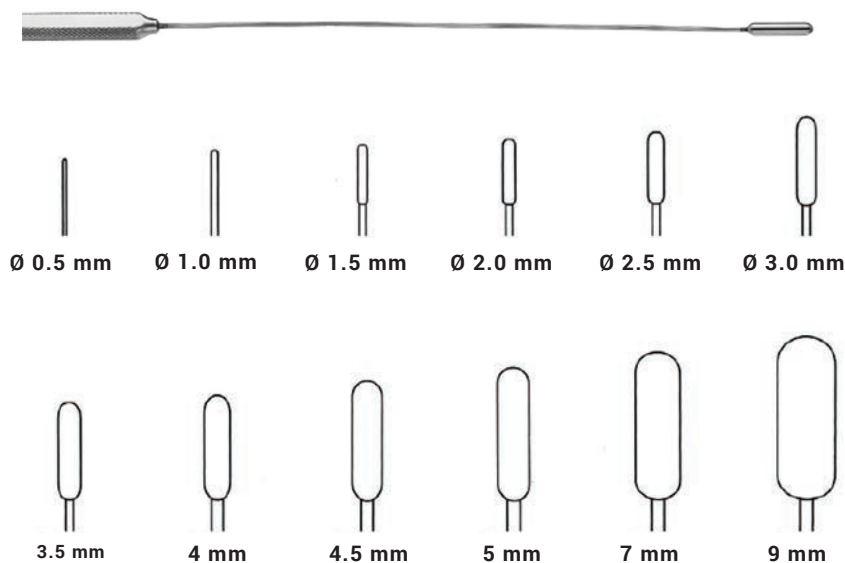
**Description**

DeBakey Vascular Dilator 0,5 mm  
 DeBakey Vascular Dilator 1 mm  
 DeBakey Vascular Dilator 1,5 mm  
 DeBakey Vascular Dilator 2 mm  
 DeBakey Vascular Dilator 2,5 mm  
 DeBakey Vascular Dilator 3 mm  
 DeBakey Vascular Dilator 3,5 mm  
 DeBakey Vascular Dilator 4 mm  
 DeBakey Vascular Dilator 5 mm  
 DeBakey Vascular Dilator 7 mm  
 DeBakey Vascular Dilator 9 mm

**Length**

19 cm  
 19 cm  
 19 cm  
 19 cm  
 19 cm  
 19 cm  
 19 cm  
 19 cm  
 19 cm  
 19 cm  
 19 cm

**Code**

CC-1400-01  
 CC-1400-02  
 CC-1400-03  
 CC-1400-04  
 CC-1400-05  
 CC-1400-06  
 CC-1400-07  
 CC-1400-08  
 CC-1400-09  
 CC-1400-10  
 CC-1400-11



### Garrett Vascular Dilator

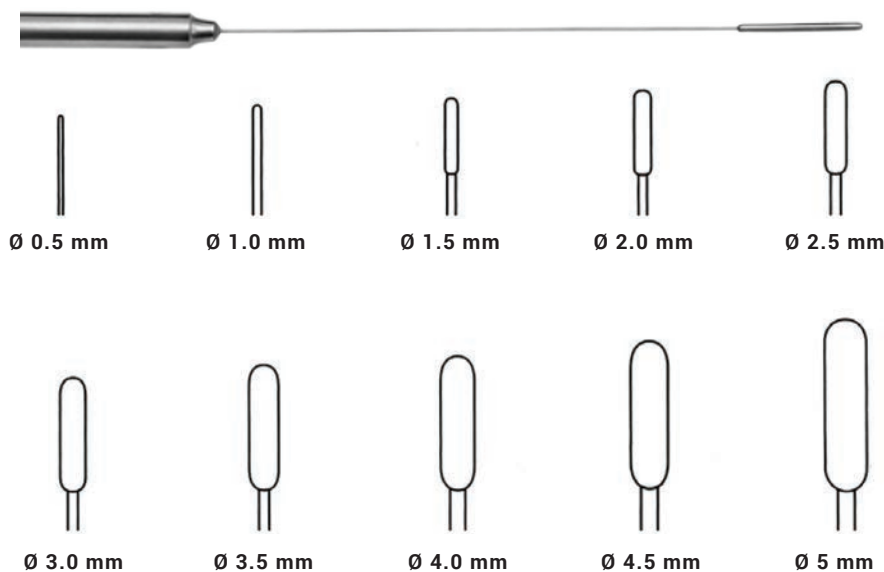

Description	Length	Code
Garrett Vascular Dilator 0,5 mm	14 cm	CC-1410-01
Garrett Vascular Dilator 1 mm	14 cm	CC-1410-02
Garrett Vascular Dilator 1,5 mm	14 cm	CC-1410-03
Garrett Vascular Dilator 2 mm	14 cm	CC-1410-04
Garrett Vascular Dilator 2,5 mm	14 cm	CC-1410-05
Garrett Vascular Dilator 3 mm	14 cm	CC-1410-06
Garrett Vascular Dilator 4 mm	14 cm	CC-1410-07
Garrett Vascular Dilator 5 mm	14 cm	CC-1410-08

Description	Length	Code
Garrett Vascular Dilator 0,5 mm	21 cm	CC-1411-01
Garrett Vascular Dilator 1 mm	21 cm	CC-1411-02
Garrett Vascular Dilator 1,5 mm	21 cm	CC-1411-03
Garrett Vascular Dilator 2 mm	21 cm	CC-1411-04
Garrett Vascular Dilator 2,5 mm	21 cm	CC-1411-05
Garrett Vascular Dilator 3 mm	21 cm	CC-1411-06
Garrett Vascular Dilator 4 mm	21 cm	CC-1411-07
Garrett Vascular Dilator 5 mm	21 cm	CC-1411-08



SPECIALITY INSTRUMENTS

**Bakes Dilator Set**

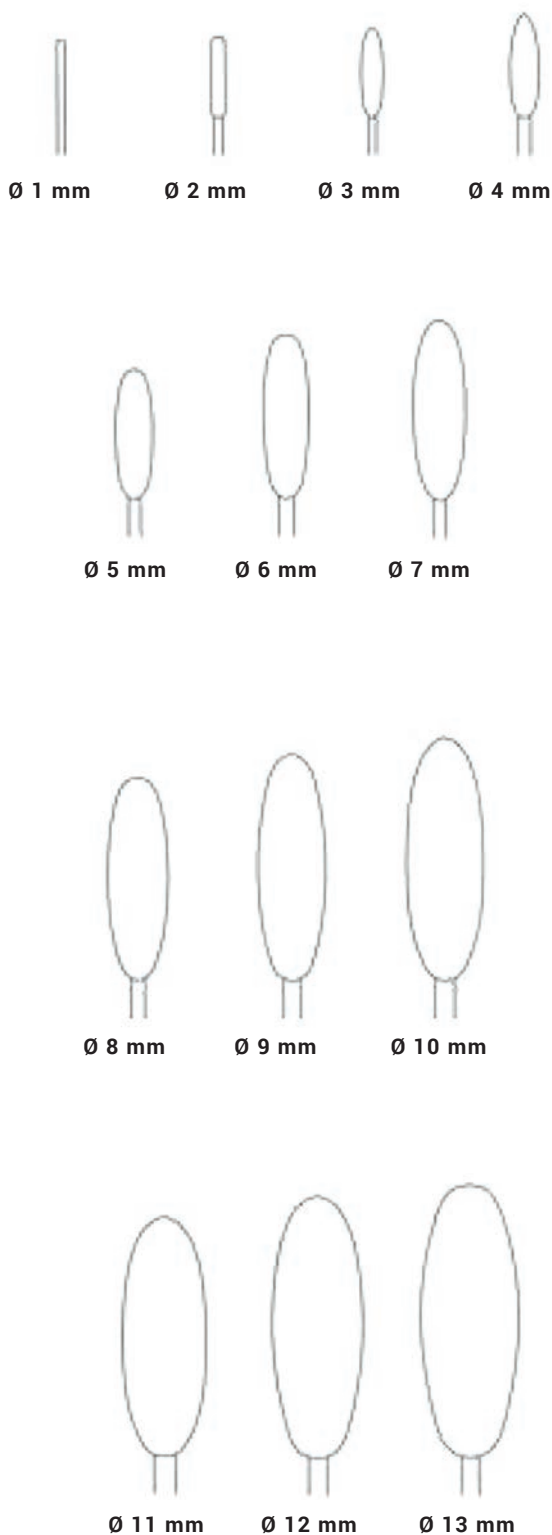

**Description**

Bakes Dilator Set 1mm - 13 mm  
 Bakes Dilator Set 1mm - 13 mm

**Length**

20 cm  
 31 cm

**Code**

CC-1415-00  
 CC-1416-00

## DeBakey Vascular Dilator Titanium Handle (Memory Nitinol Wire)

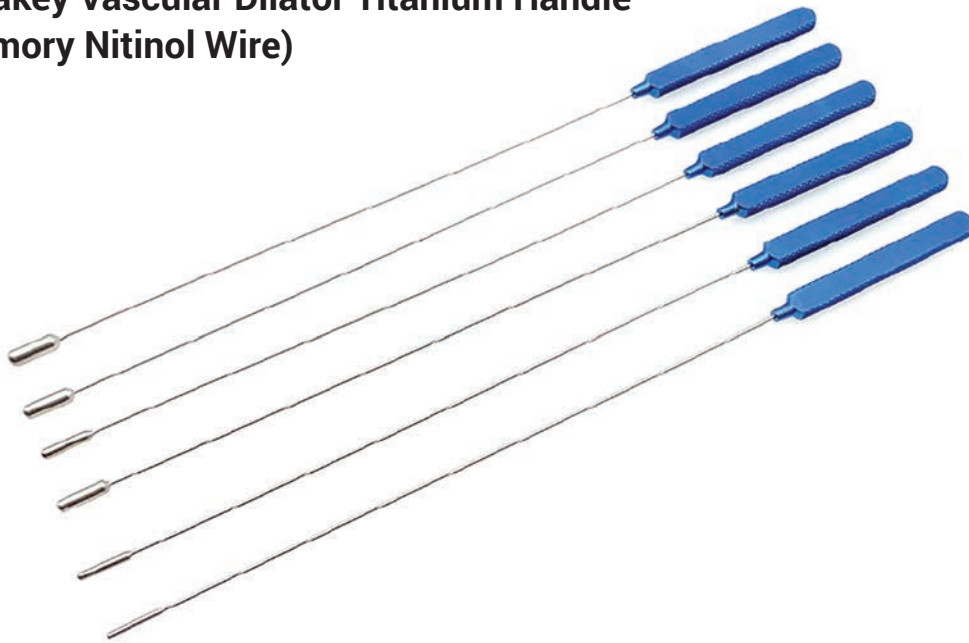

### Description

DeBakey Vascular Dilator Titanium Handle 0.5 mm - 9 mm

### Length

19 cm

### Code

CC-1417-00

## Leksell Bone Rongeur



### Description

Leksell Bone Rongeur 3 mm

Leksell Bone Rongeur 5 mm

Leksell Bone Rongeur 8 mm

### Length

24 cm

24 cm

24 cm

### Code

EA-6221-03

EA-6221-05

EA-6221-08

**Cushing Nerve Hook**

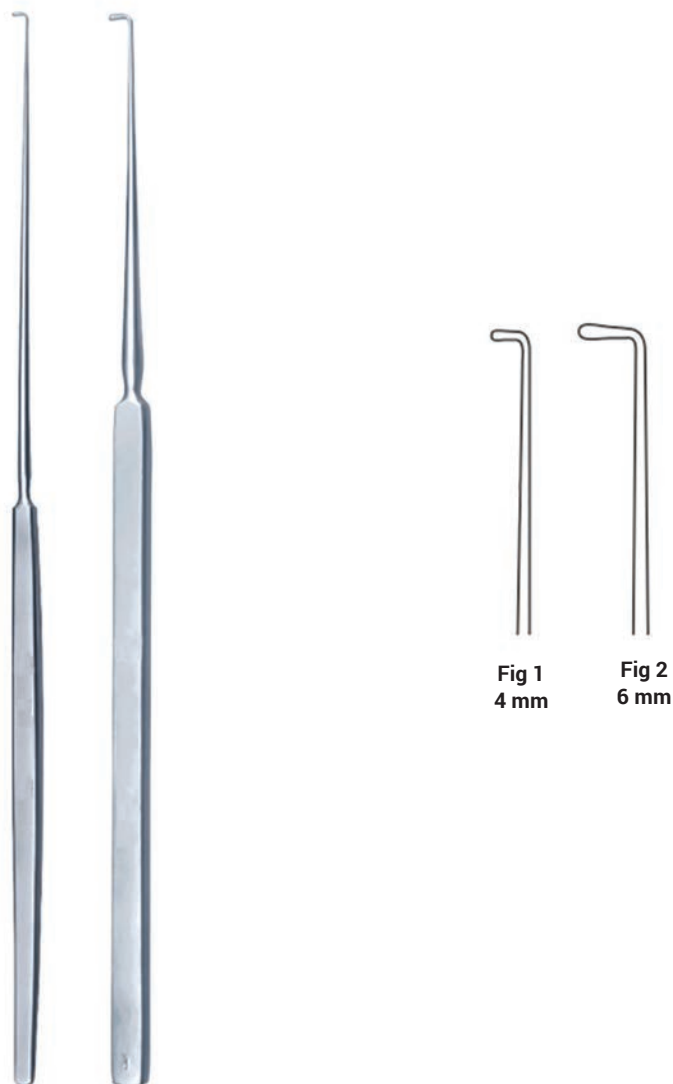

**Description**

- Cushing Nerve Hook 4 mm Fig 1
- Cushing Nerve Hook 6 mm Fig 2
- Cushing Nerve Hook 4 mm Fig 1
- Cushing Nerve Hook 6 mm Fig 2

**Length**

- 19 cm
- 19 cm
- 28 cm
- 28 cm

**Code**

- CA-3473-19
- CA-3474-19
- CA-3473-28
- CA-3474-28



### Hegar Dilator Set



**Description**

- 1. Hegar Dilator Set 26 Pieces 1 mm x 26 mm
- 2. Hegar Dilator Set 8 Pieces 4 mm x 17 mm
- 3. Storage Case Stainless

**Code**

- CC-9800-01
- CC-9800-02
- CC-9800-03

### Tubbs Aortic Dilator

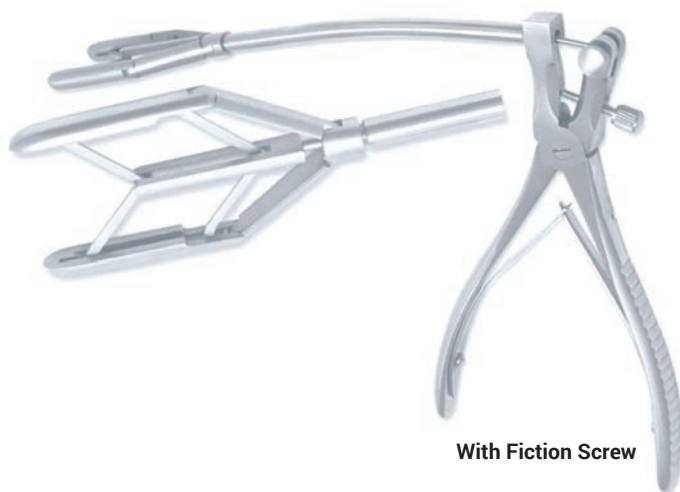

**Description**

Tubbs Aortic Dilator Opening 8 mm - 42 mm

**Code**

CC-9800-10



SPECIALITY INSTRUMENTS

Cardiac Tube Holders

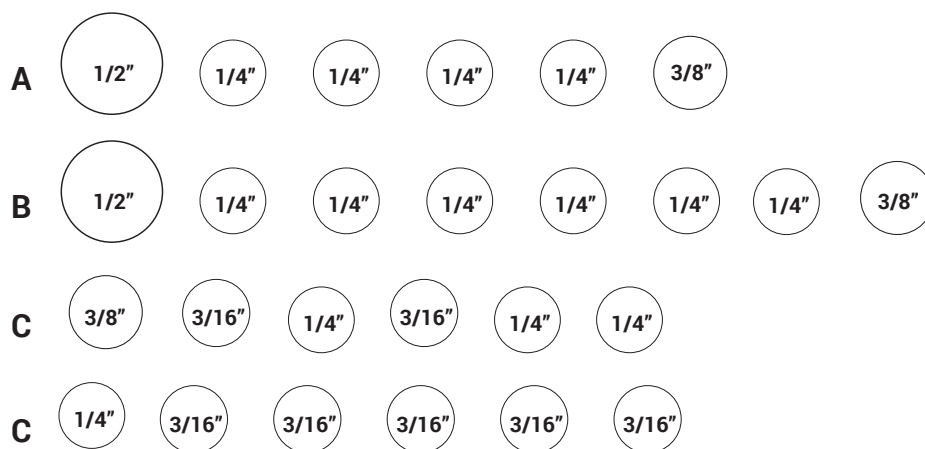
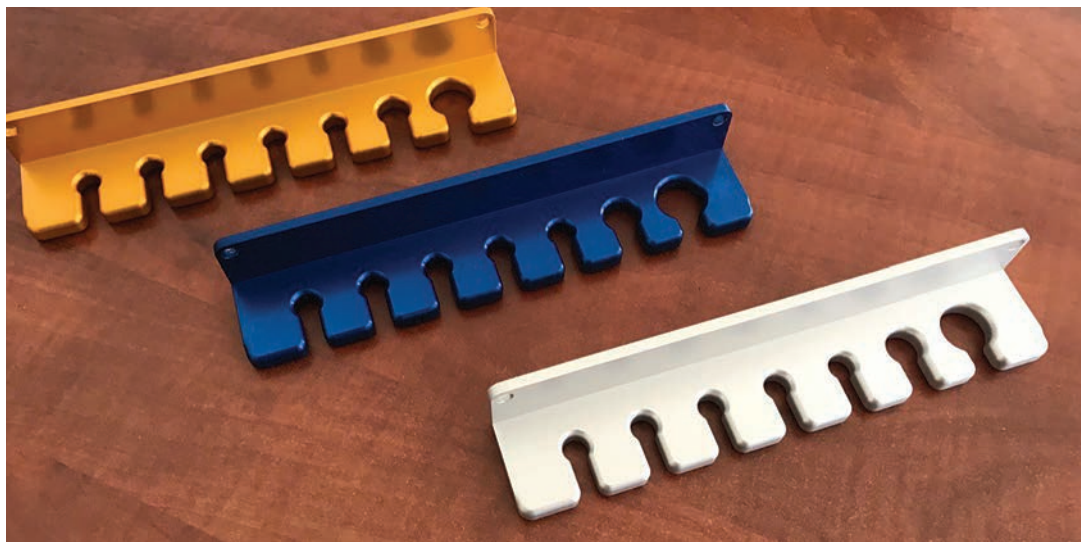

Description

Code

- A** Cardiac Tube Holders
- B** Cardiac Tube Holders
- C** Cardiac Tube Holders
- D** Cardiac Tube Holders

- CC-1800-01
- CC-1800-02
- CC-1800-03
- CC-1800-04

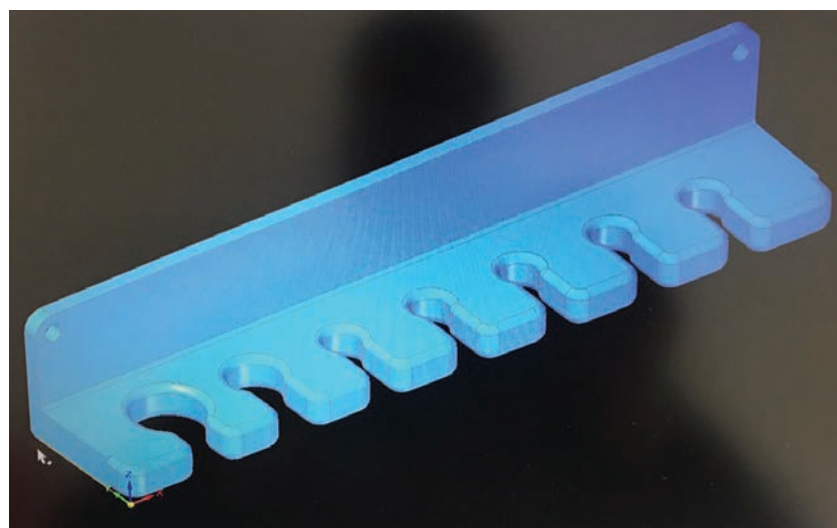

## Ligature Catcher



### Description

Ligature Catcher 1.5 mm  
 Ligature Catcher 2 mm  
 Ligature Catcher 2.5 mm  
 Ligature Catcher 3 mm

### Length

24 cm  
 24 cm  
 24 cm  
 24 cm

### Code

CC-1339-01  
 CC-1339-02  
 CC-1339-03  
 CC-1339-04



SPECIALITY INSTRUMENTS

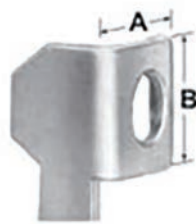



**Authorised Dealer / Agent**

[www.skillinstruments.co.za](http://www.skillinstruments.co.za)

**SKILL® Surgical Instruments**  
Rottweiler Street 53  
D-78669 Wellendingen  
Germany